

# The Wireless AND RADIO REVIEW World

No. 303.

WEDNESDAY, JUNE 3RD, 1925.

VOL. XVI. No. 17.

Assistant Editor:  
F. H. HAYNES.

Editor:  
HUGH S. POCOCK.

Assistant Editor:  
W. JAMES.

Editorial Offices: 139-40, FLEET STREET, LONDON, E.C.4

Telephone: City 4011 (3 lines).

Advertising and Publishing Offices: DORSET HOUSE, TUDOR STREET, LONDON, E.C.4.

Telephone: City 2847 (13 lines).

Telegrams: "Ethaworld, Fleet, London."

COVENTRY: Hertford Street.

BIRMINGHAM: Guildhall Buildings, Navigation Street.

MANCHESTER: 199, Deansgate.

Telegrams: "Cyclist Coventry."  
Telephone: 10 Coventry.

Telegrams: "Autopress, Birmingham."  
Telephone: 2970 and 2971 Midland.

Telegrams: "Hiffe, Manchester."  
Telephone: 8970 and 8971 City.

Subscription Rates: Home, £1 1s. 8d.; Canada, £1 1s. 8d.; other countries abroad, £1 3s. 10d. per annum.

As many of the circuits and apparatus described in these pages are covered by patents, readers are advised, before making use of them, to satisfy themselves that they would not be infringing patents.

## PATENTS AND RADIO DEVELOPMENT.

PROBABLY few people realise how important an influence the Patent situation in a country may have on radio development. On first consideration it would be very natural to conclude that the greater the freedom of manufacturers to make use of patents under suitable licensing conditions, the more favourably situated would be the industry as a whole, but, if we proceed to investigate further, it can be shown that, under certain circumstances, this freedom to make use of patents may be not only a handicap to progress, but a definite menace to radio development, even constituting a contributory cause to a nation being left far behind in the race to develop and perfect wireless equipment.

The issue of *The Wireless World* last week, dated May 27th, was devoted primarily to a review of broadcasting and its development abroad. A study of the contributions to that issue reveals many interesting circumstances which have controlled wireless progress in different countries. Our contributor writing on "Radio in the United States," pointed out that the development of wireless receivers in that country has been largely governed by the circumstances of the Patent situation. It was shown that in America the principal patents were held by two manufacturing groups, each group licensing only manufacturers who operated within the organisation of the group. In this way keen competition was stimulated between the two groups in the electrical design of apparatus, but within the groups themselves we

assume that competition was limited to the application of these patents to designs of sets which were otherwise evolved independently by respective manufacturers.

### "Pooled" Patents v. Independent Operation.

In our own country the position is different. Most of the controlling patents are claimed by one company, and manufacturers make use of these patents under licence. The policy of the licensors is to grant free use of their patents to any *bona fide* manufacturer who desires to make use of them on payment of royalties. The net result is that every manufacturer in this country is on an equal footing with his competitors so far as the use of all the commoner wireless circuits are concerned. Commercially it is unprofitable for these licensed manufacturers to expend even a part of their resources in research work towards the development of new circuits. Particularly is this the case in view of the terms under which the licence is granted, which are to the effect that the licensee agrees to pay a royalty per valve on any valve apparatus, irrespective of the circuit employed, so that, even should an individual manufacturer devote his energies

to producing new circuits, he still would continue to pay royalties on any sets employing that circuit, unless he were in a sufficiently strong position to devise circuits which did not infringe existing patents, so that he could operate as an independent unit. So long, however, as the easier path for manufacturers in this country is to pay royalties and thereby be enabled to produce wireless sets which are as efficient as anything which their rivals

## CONTENTS.

	PAGE
EDITORIAL VIEWS ... ..	531
SELECTIVE FOUR-VALVE BROADCAST RECEIVER ... ..	533
By W. James.	
SYNCHRONOUS SIGNALLING BY SOUND AND WIRELESS ... ..	538
By W. G. W. Mitchell.	
READERS' NOVELTIES ... ..	542
CURRENT TOPICS ... ..	544
EUROPEAN REGULAR BROADCAST TIMES	546
NEWS FROM THE CLUBS ... ..	548
VALVES WE HAVE TESTED: THE B.T.H. B3 AND B7 ... ..	549
INTERFERENCE FROM ADJACENT AERIALS ... ..	550
By W. H. F. Griffiths.	
CALLS HEARD ... ..	554
BROADCAST BREVITIES ... ..	555
RECENT INVENTIONS ... ..	557
NEW APPARATUS ... ..	559
LETTERS TO THE EDITOR ... ..	560
READERS' PROBLEMS ... ..	561

can produce, there is not likely to be any enterprise shown on the part of individual manufacturers towards the development of new circuits and devices.

Let us consider what would be the position if in this country every company owning patents reserved those patents exclusively for their own use and discontinued the practice of licensing other manufacturers. So much money has been sunk in manufacturing plant that it is inconceivable that manufacturers would go out of business on a wholesale scale; instead, they would be compelled to devote themselves to devising new circuits which would be independent of existing patents. Admittedly this would be an exceedingly difficult task, but it seems to us that in principle it could only have the effect of stimulating enterprise, and would result in the early development of a variety of circuits, and place every manufacturer in the position of competing in the electrical design of apparatus, instead of merely in the production of sets involving circuits which were equally at the disposal of all his competitors.

#### Stimulating Competition.

Looking at the situation in this country superficially, one is naturally disposed to consider that the attitude of organisations controlling the principal wireless patents in giving facilities to manufacture under licence has been a generous one, but searching more deeply into the position, it appears that an adequate return for this generosity (apart from the consideration of the revenue from licence fees) has been obtained by the fact that it has prevented any active competition in the development of new ideas by manufacturers who, under normal circumstances, would have been obliged to undertake a considerable amount of research of their own. Nothing stimulates invention like necessity, and so long as there is no necessity for individual manufacturers to invent, and they continue to have at their disposal the product of the research departments and inventive genius of the staff of another organisation, what is there left to stimulate individual research work on the part of the manufacturers in this country?

o o o o

#### BOTTLED PROGRAMMES.

UNDER the title of "Bottled Programmes" we referred editorially in the issue of March 18th, to the desirability of making records of performances so that they could be broadcast at times when it might be inconvenient for the ordinary transmissions from the Studio to take place. We notice that recently the idea of "bottled" programmes has been discussed in the daily Press and described as a new possibility in broad-

casting. We believe that broadcasting could be made even more popular than it is at present if transmissions were made more frequently during the day-time hours, and we have already advocated that if a continuous change of programme is too big a task to be undertaken at the moment, the possibility exists for a compromise by arranging to broadcast during the day a record taken of, say, the evening programme of the previous day.

According to an official of the British Broadcasting Company, the possibility of "bottled" programmes, which we had suggested, is receiving the serious consideration of the company, and it is promised that within six months, methods of obtaining satisfactory results from records prepared in this way will have neared, if not actually reached, perfection.

It is suggested that, apart from the more usual applications of this method of recording, it will eventually be possible to make a permanent record of events of historic interest, as, for example, the speech of His Majesty the King on the occasion of the opening of the British Empire Exhibition.

For various technical reasons we incline to the opinion that the most promising results from known methods of recording music and speech are likely to be obtained from the system which is used in conjunction with what is commonly known as the "speaking film." The method may be, perhaps, a little more elaborate and slightly more costly to carry out, but the record will be a permanent one, and should be capable of giving more favourable reproduction than seems probable by other known methods.

o o o o

#### THE FATE OF THE WIRELESS BILL.

THE Prime Minister has announced that the Wireless Telegraphy and Signalling Bill recently drafted by the Postmaster-General, will not be dealt with during the present session of Parliament, but that in its place, as a temporary alternative, the House

will be asked to approve a Bill which is intended merely to clarify the legal position of the Postmaster-General in respect of the granting of wireless licences. It seems to be generally recognised that the Bill previously drafted will have to be substantially revised by the Postmaster-General before it is again presented to the House. It will be interesting to know the wording of the proposed temporary Bill, and this will require to be carefully scrutinised to see that it does not extend the powers of the Postmaster-General in any of the directions which called for such strong criticism of the terms of the earlier Bill. After having seen the text of the original draft Bill, the new Bill will naturally be viewed with suspicion.

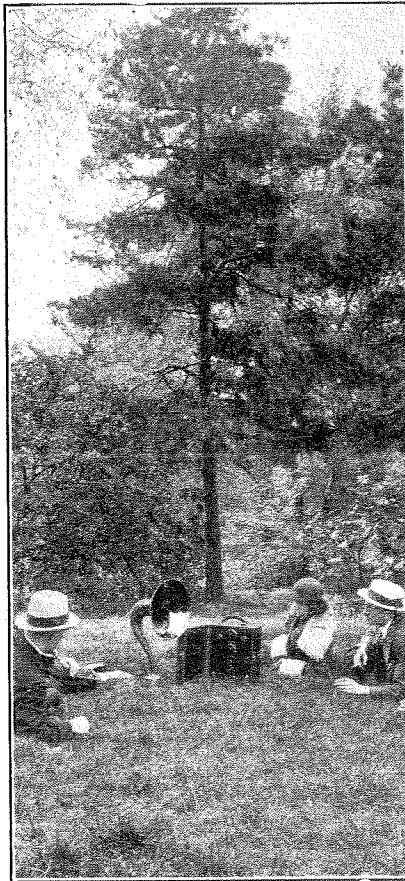

The joys of outdoor wireless. A picnic with a portable set.

# SELECTIVE FOUR VALVE BROADCAST- RECEIVER

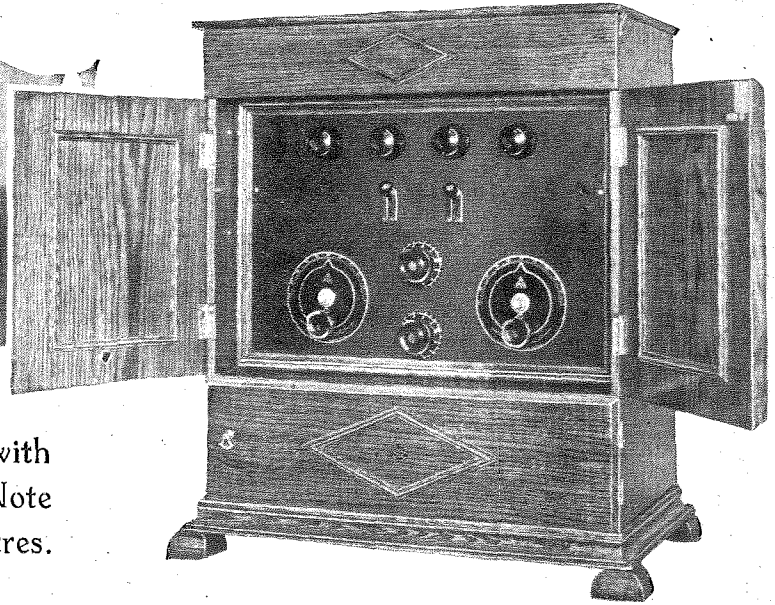

A Coupled Circuit Receiver with Valve Detector and Three Note Magnifiers for 200-550 Metres.

By W. JAMES.

PERHAPS the simplest way of tuning an aerial to the wavelength of a transmitting station is by adding inductance to the aerial circuit. If the resonance curve of such a circuit is taken, it will be found that although the maximum signal strength is obtained for the wavelength to which the circuit is tuned, the circuit responds to a band of wavelengths. Hence, if there are other near-by stations of similar power working on wavelengths separated by only a few metres, these will be heard if a detector is connected across the inductance. The tuning of this type of circuit is said to be broad or flat, and, referring to the broadcast transmissions, this means that it will not be possible to tune out the local transmitting station and get another one of similar power working on a wavelength anywhere near that of the local station.

To improve the selectivity we may connect a condenser in series with the aerial, and increase the inductance of the coil to give resonance at the desired wavelength. In general, the smaller the capacity of this condenser, the sharper the resonance curve. The selectivity can, therefore, be varied by using an adjustable condenser in series with the aerial, the value of the inductance being altered to give resonance.

The next step towards improving the tuning characteristics is to connect a variable condenser across the aerial inductance. This gives the circuit seen on the left-hand side of Fig. 1, the aerial being connected to terminal A<sub>1</sub> and the earth to E. With these connections we can get fairly good selectivity. By reducing the capacity of the series condenser, or increasing the capacity of the parallel condenser, C<sub>1</sub>, the selectivity is improved. This circuit

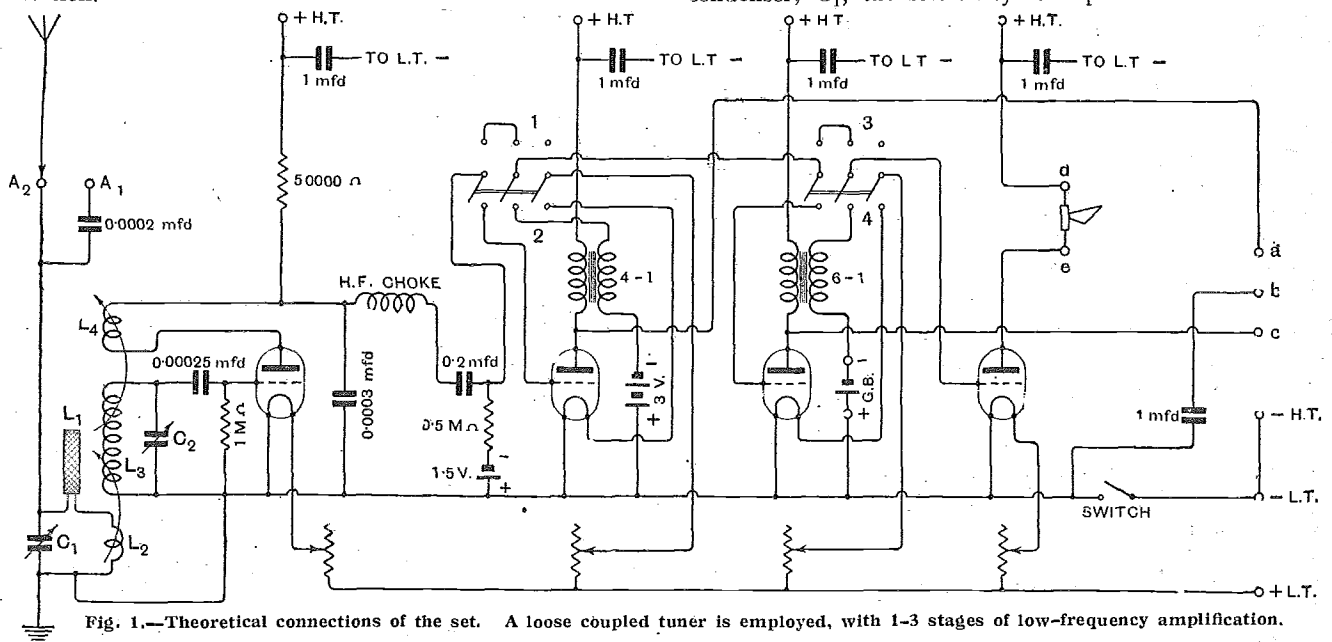

Fig. 1.—Theoretical connections of the set. A loose coupled tuner is employed, with 1-3 stages of low-frequency amplification.

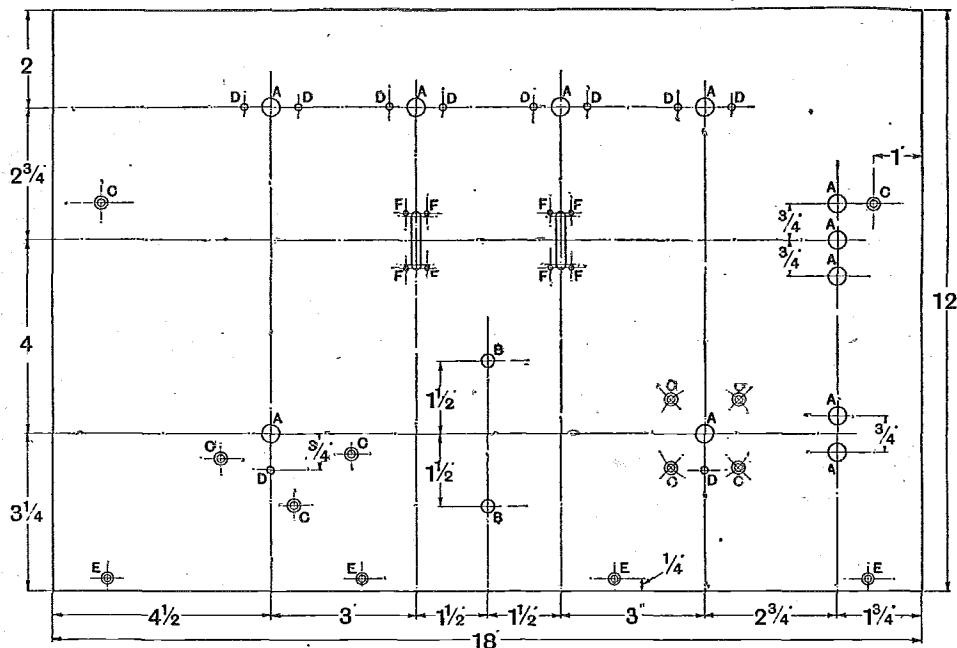

Fig. 2.—Drilling details of front ebonite panel. A,  $\frac{3}{8}$  in. dia.; B,  $\frac{3}{8}$  in. dia.; C,  $\frac{5}{8}$  in., and counter-sunk for No. 4 B.A. screws; D,  $\frac{3}{8}$  in. dia.; E,  $\frac{1}{4}$  in. dia.; F,  $\frac{3}{8}$  in. dia.

arrangement is similar to a coupled circuit, the coupling being weakened by increasing the ratio of the capacity of the parallel condenser to that of the series condenser.

With a circuit of this sort connected to a large aerial situated, say, four miles from 2L.O., and with reaction, it is usually possible to tune out this station by moving the condenser dial a few degrees. Even so, the arrangement is not sufficiently selective to enable one to bring in Manchester without London. This may be done, however, by employing a coupled circuit.

The arrangement of a coupled circuit is well known, and the method employed in this set is given in Fig. 1, where  $L_2$  is the coupling coil and  $L_3$  the closed circuit coil. When the coupling coil is put in a certain position with regard to the closed circuit coil, no energy is transferred to the latter coil, and by altering the position of the coupling coil the selectivity can be varied to suit requirements. To be successful with a coupled circuit the coupling should be loose. For values of coupling beyond a certain point the tuner has a double peak resonance curve, the humps or peaks separating and becoming bigger as the coupling is tightened.

Not only is it necessary to employ loose magnetic coupling; it is essential to minimise capacity coupling between the aerial and closed circuits if a powerful local station is to be eliminated.

This is done in practice by:—

- Suitably arranging the aerial and closed circuit coils,
- Employing only a few turns in the coupling coil.
- Earthing the end of coil  $L_3$ ,
- Putting the coupling coil at the earth end of the aerial circuit, and
- Mounting this coil a short distance from the earthed end of the closed circuit coil.

Separating coils  $L_2$  and  $L_3$  reduces the capacity between them, and as they are both earthed, only a negligible amount of energy is transmitted by this capacity. It was found by experiment that the results were still further improved by winding

the coupling coil  $L_2$  with fine wire (No. 30).

The Effect of Reaction.

A considerable improvement in selectivity and signal strength can, of course, be obtained by reacting on to the tuner. In the case of the single circuit tuner discussed above, the effect of reaction applied to the aerial coil would be to improve the sharpness of tuning and signal strength by decreasing the effective resistance of the circuit.

The actual increase of selectivity which can be obtained by reaction is largely determined by the height of the aerial. As a rule very much better selectivity can be obtained when a low aerial is used, although in the case of an aerial surrounded by absorbing objects, such as

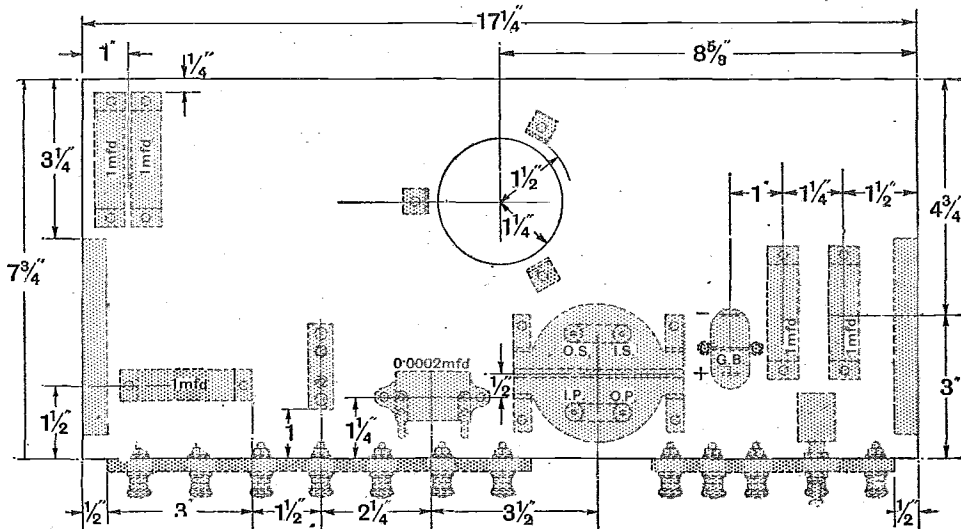

Fig. 3.—Arrangement of parts on the base board.

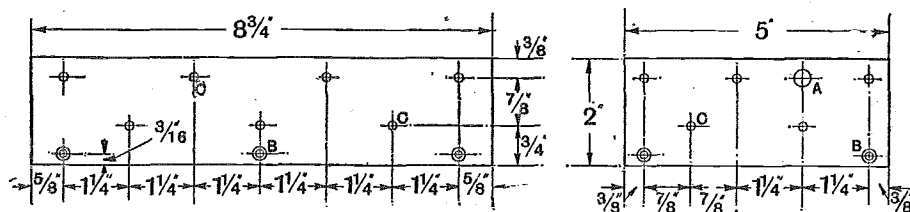

Fig. 4.—Details of the terminal strips which are of 1/4 in. ebonite. A, 1/8 in. dia.; B, 1/4 in. dia., and countersunk for No. 4 wood screws; C, 3/8 in. dia., for No. 4 B.A. terminals.

houses, trees, sheds, etc., and neighbouring aerials, the actual signal strength may fall off a little. The effect of employing a coupled circuit is, in a way, equivalent to reducing the height of the aerial, while still employing a high one.

It is sometimes thought that reaction will compensate for poorly designed circuits, but this is not so.

The selectivity of a good coupled circuit with reaction is far better than that of a plain aerial circuit with reaction. It is preferable to couple the reaction coil to the closed circuit, and these should be separated a little to minimise the effects of the capacity between them.

The capacity is also reduced by employing a reaction coil which is not too large, physically, and wound with fine wire. In the receiver under discussion the reaction coil is mounted a short distance from the grid end of the closed circuit coil, and only a slight change in the tuning is necessary to compensate for big changes in the position of the reaction coil.

**The Detector Circuit.**

It has been found experimentally that a smooth, easy control of reaction can be obtained by the arrangement shown in Fig. 1, the valve used in the detector stage being a D.E.5 or B.4. The grid leak is connected between the grid and negative L.T., and the value chosen,

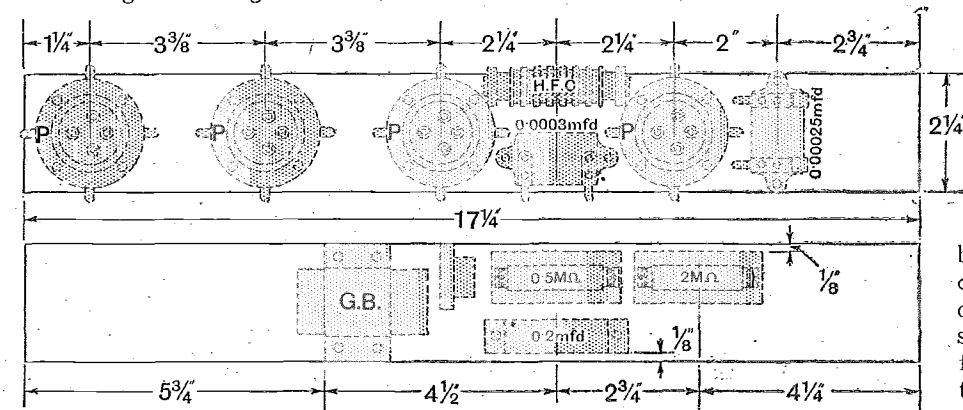

Fig. 6.—Arrangement of parts on the upper and lower sides of the valve shelf. The fixing holes should be drilled and tapped.

1 megohm, is a compromise between good signal strength and good quality. Signals are usually much louder when a grid leak of 2-4 megohms is used, but it is found that a noticeable improvement in quality is produced by using the leak of lower value. In the plate circuit with the reaction coil  $L_1$  is a 50,000 ohms Zenite resistance rod—a value of resistance about six times the impedance of the valve. This resistance has the effect of straightening out the plate current grid voltage characteristic of the valve, and, of course, provides a reasonable amount of voltage amplification. The resistance is shunted by a fixed condenser of 0.0003 mfd., which forms

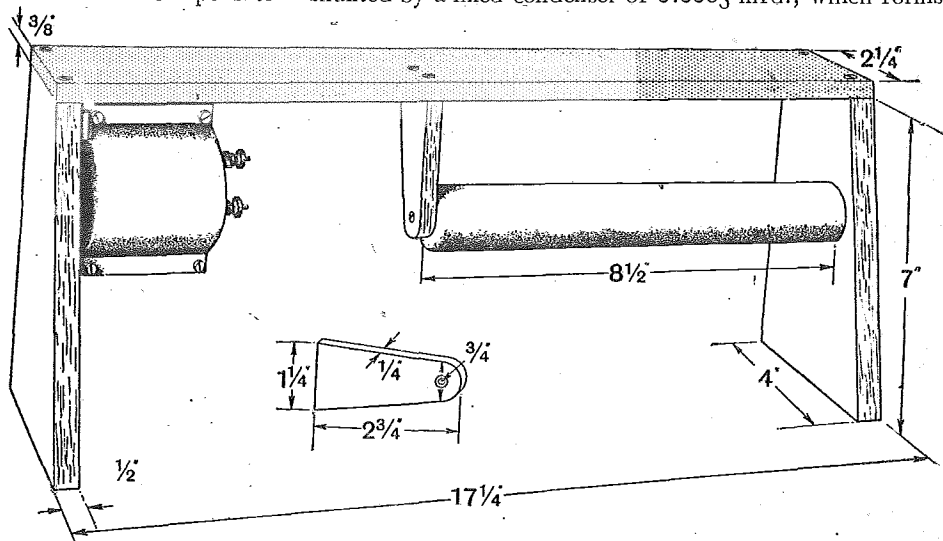

Fig. 5.—View of the valve shelf, with its wooden supports, showing in particular the position of the 6 to 1 Ideal transformer, and the 50,000 ohms Zenite resistance rod.

a path for the high-frequency component of the plate current.

A point frequently overlooked, however, is that a condenser of this capacity does not act as a short-circuit across the amplifier to high-frequency currents of the lower broadcast wavelengths, and it was found essential to employ a carefully wound high-frequency choke coil, H.F. CHOKE, as indicated in Fig. 1.

When this choke was not used, it was found possible to operate a loud-speaker at full strength with the detector valve removed from its holder. If the reader does not wish to construct a suitable choke, he should increase the capacity of the by-pass condenser to about 0.002 mfd., but, as a condenser of this size will shunt away speech currents of the higher frequencies, it is recommended that a H.F. choke be used.

There is no doubt that the bad quality so prevalent in

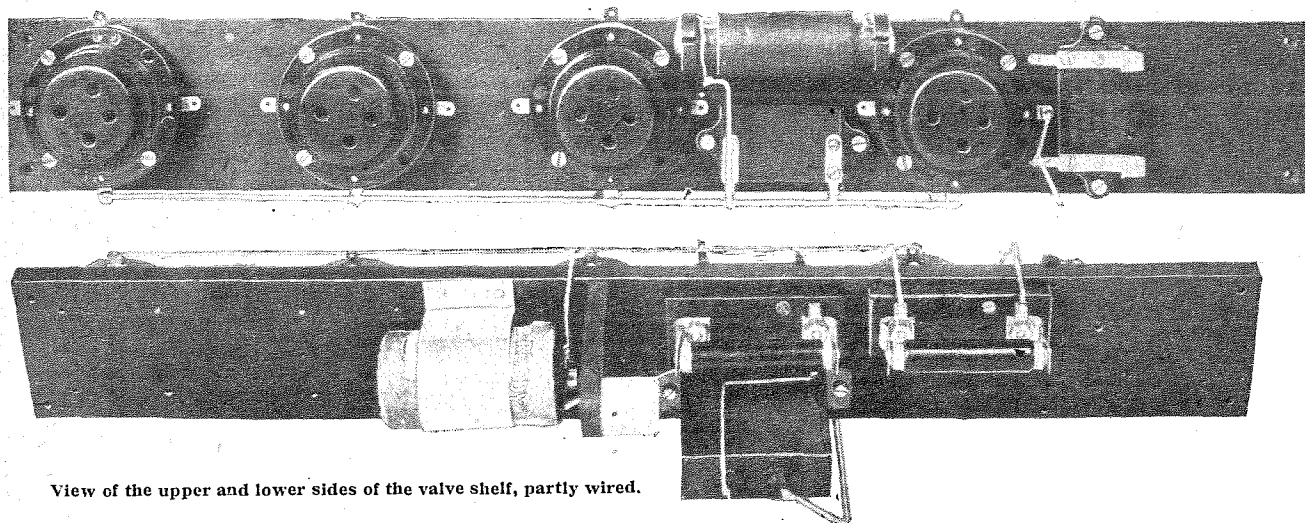

View of the upper and lower sides of the valve shelf, partly wired.

hastily designed resistance-coupled amplifiers is largely due to the high-frequency currents which pass into the amplifier through neglecting to provide the component which we have been discussing.

#### Novel Switching Arrangements.

Three note magnifiers are employed, and any or all of them can be connected in circuit by operating the switches. Usually two note magnifiers only are provided, but here we are dealing with a receiver which is capable of bringing in a large number of broadcast stations, and as some of them are weak, plenty of good low-frequency amplification is desirable for loud-speaker reception.

The switching system has been developed on logical lines, and does not follow the usual method of cutting

out the last valve first. It should be explained at this point that a D.E.5B. valve is used in the first stage with a 4 to 1 transformer, a D.E.5 valve in the second stage, with a 6 to 1 transformer and an L.S.5A or D.E.5A valve in the last stage. The grid bias for the first valve is  $1\frac{1}{2}$  volts, and for the second  $4\frac{1}{2}$  volts.

The stages, comprising a valve with its transformer, therefore give a voltage amplification of about 70 and 40, with 3 for the L.S.5A. valve. Now, when receiving a strong signal, such as the local B.B.C. station, the voltage developed across the anode resistance might be, say, 0.7 volts. This should be applied to the grid of the third valve by putting the switches in positions 1 and 4, which will bring it up to 28 volts, and this voltage is applied to the grid of the last valve.

If the signal is a weak one, giving, say, 0.01 volts across the anode resistance, this would be applied to the first valve by putting the first switch in position 2. This stage would magnify it about 70 times, giving 0.7 volts, which could be applied to the third valve by putting the second switch in position 4. The output from this valve would be of the order of 28 volts, and is applied to the last valve.

Two telephone receiver sockets are provided, and the telephones, to which are fitted a telephone two-pin plug, may be put in sockets *ab* or *bc*, *ab* being connected to the first note magnifier, and *bc* to the second. If desired, the telephones may be plugged in sockets *d e*, the H.T. reduced, and the second and third valves cut out by putting the switches in positions 1 and 3.

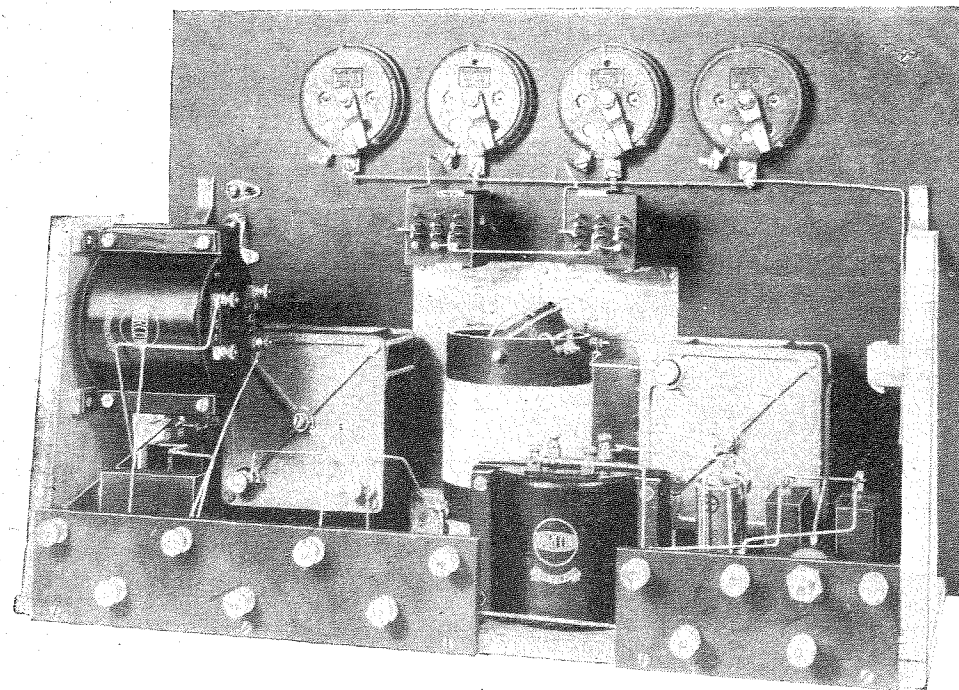

Rear view of the set with the valve shelf removed, and partly wired.

**Selective Four Valve Broadcast Receiver.—**

**Building the Set.**

The accompanying figures and illustrations show the construction of the receiver. There is a front ebonite panel which carries the two tuning condensers, the reaction and coupling coils, the filament resistances, the switches, and the telephone and loud-speaker sockets. These parts are arranged on the panel as indicated in Fig. 2, the right-hand condenser tuning the aerial circuit. In the original set a Burndept condenser was also used to tune the closed circuit, but this condenser was taken out and one of the square law type put in, as shown by the pictures of the finished set.

A baseboard is screwed to the lower edge of the panel, and on this is mounted a number of parts and the valve shelf. The base board measures  $17\frac{1}{4}$  in.  $\times$   $7\frac{3}{4}$  in.  $\times$   $\frac{1}{2}$  in., and the parts shown in Fig. 3 are mounted on it. These include the H.T. battery condensers, an intervalve transformer, the fixed condenser connected in the aerial, the terminal strips (Fig. 4), the plug-in coil socket, and the closed circuit coil with its reaction and coupling coils as described below.

The valve platform is of ebonite measuring  $17\frac{1}{4}$  in.  $\times$   $2\frac{1}{4}$  in.  $\times$   $\frac{3}{8}$  in., and is carried by two wooden supports,

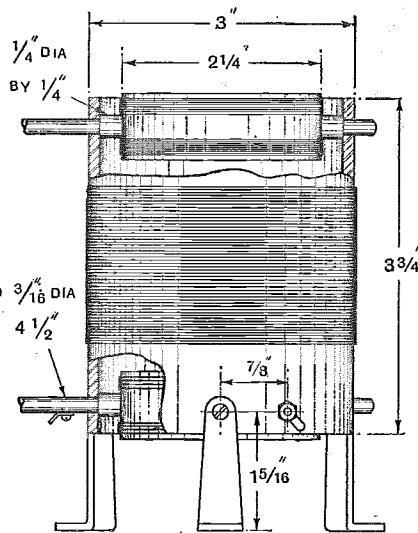

Fig. 7.—Sketch of the closed circuit coil with the reaction (upper) and coupling (lower) coils. This unit is supported by three brass feet.

Fig. 5. On the upper side of the ebonite strip is mounted the valve-holders, fixed condensers, and H.F. choke, and on the lower side the grid leaks for the first and second valves, the 0.2 mfd. coupling condenser and the single cell grid

bias battery. The H.F. choke consists of a winding of 700 turns of No. 40 D.S.C. copper wire wound 100 turns each in seven slots, cut in a rod of ebonite  $2\frac{3}{8}$  in. long by  $\frac{3}{8}$  in. diameter, as shown in the illustrations. This choke must have a low self capacity, and any type of coil with this property—such as a basket coil—can be used here. The choke used in this set is held by two small brass

brackets which are screwed to the valve shelf and to the ends of the choke. These parts are shown in Figs. 5 and 6, which also show the method of mounting the anode resistance. Two short pieces of round wood are tapered to fit the ends of the Zenite rod; one is screwed to the right-hand support of the valve platform and the other is screwed to a small piece of ebonite or wood mounted on the underneath side of the valve platform.

On the left-hand support for the valve shelf the 6 to 1 transformer is fastened. It was found necessary to place a piece of wood about  $\frac{1}{8}$  in. thick below the feet to raise the case of the transformer away from the support.

Two brass stays are fitted between the panel and the supports of the valve platform, as shown in the illustrations. These stays are constructed from pieces of brass strip  $\frac{3}{8}$  in.  $\times$   $\frac{1}{8}$  in., the ends being bent to fit and the supports grooved in order to take the ends.

(To be concluded.)

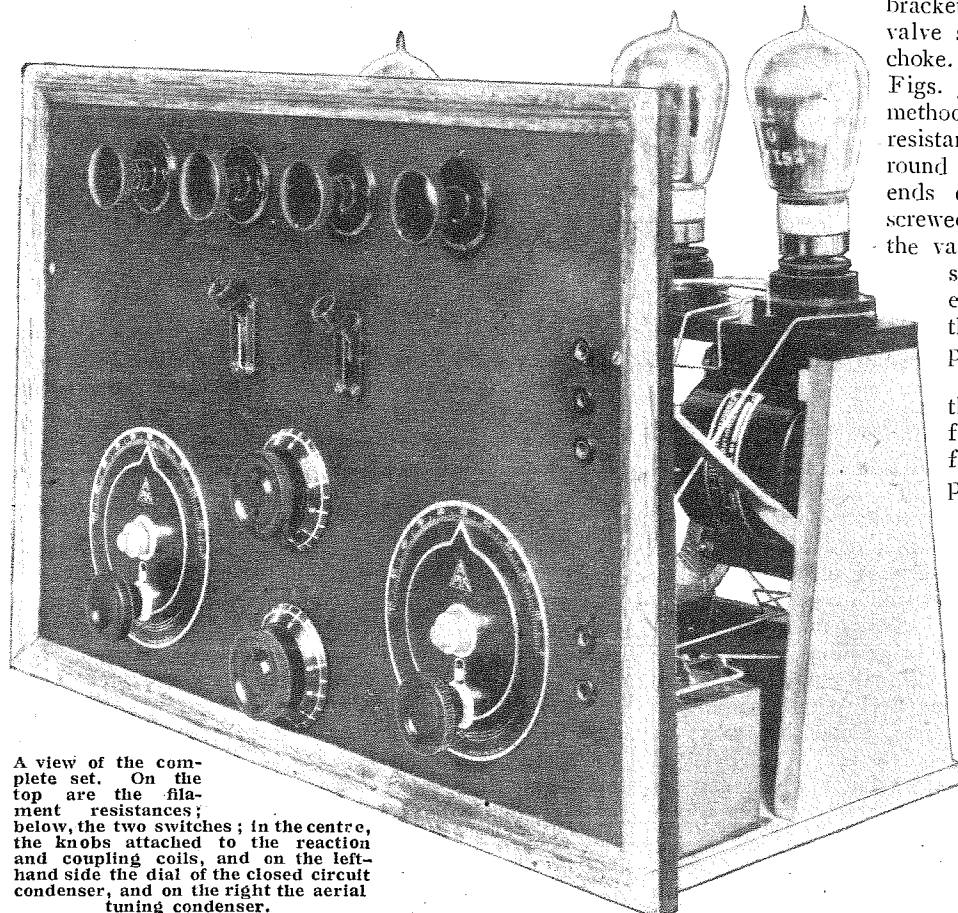

A view of the complete set. On the top are the filament resistances; below, the two switches; in the centre, the knobs attached to the reaction and coupling coils, and on the left-hand side the dial of the closed circuit condenser, and on the right the aerial tuning condenser.

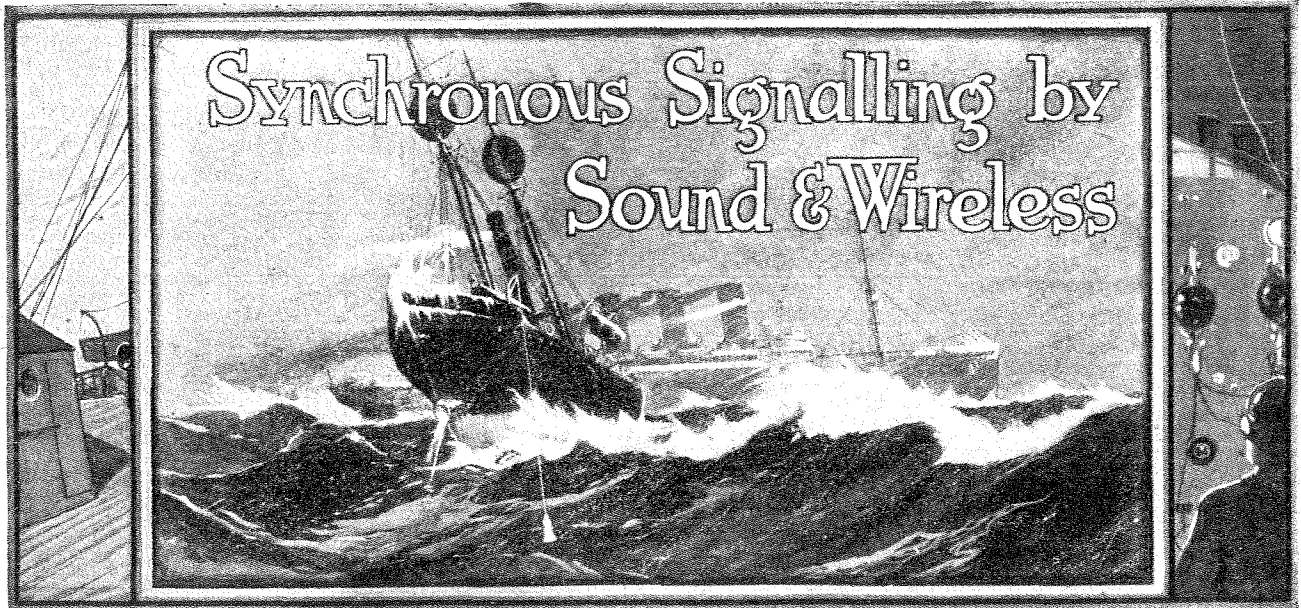

# Synchronous Signalling by Sound & Wireless

By W. G. W. MITCHELL, B.Sc., F.R.A.S., F.R.Met.S.

**S**YNCHRONOUS signalling provides a means of ascertaining the distance of a ship from a light-vessel, or other transmitting station, when ordinary methods are not available, e.g., in a fog.

With this system, a radio signal and a subaqueous sound signal are sent from the transmitting station simultaneously, and received at the observing ship separated by an interval of time which is directly proportional to the distance between the two. This distance is equal to the product of the observed time interval and the velocity of sound in (sea) water, the velocity of propagation of radio waves being taken as infinite (an assumption which introduces no measurable error).

### How Distance is Determined.

The principle underlying the idea is familiar in everyday science. Synchronous signalling may be defined as that system of signalling which permits the use of signals propagated in different media, but timed to start at the same instant. Advantage is taken of the fact that the two media chosen transmit waves which travel at different speeds. For example, a signal sent by radio by vibrating the ether reaches a point 20 or 30 miles away practically instantaneously. Another signal sent under water travels at a definite, but comparatively slower, rate and takes a measurable period of time, amounting to 30 or 40 seconds to reach the same point. It is the delayed action or lag of the under-water signal which can be turned to such useful purpose in the experiments which are to be described.

At the present time of writing there are five stations equipped with apparatus for sending submarine signals

*Submarine signalling by means of sound waves is more dependable than sound transmitted through the air. By making a simple comparison between the difference in time of receiving a signal transmitted through the water and one received by wireless, a ship at sea can readily determine its distance from the source of the signals. This is yet another application of wireless to the safeguarding of life at sea during foggy weather.*

simultaneously with radio signals. The stations are distributed as follows:—

The Gyedser Rev. Light-Vessel anchored off the Baltic coast and the Graa Dyb Light-Vessel off the North Sea coast of Denmark; the Borkum Riff Light-Vessel off the (Germany) North Sea entrance to the River Ems; the Maas Light-Vessel (Holland) at the entrance to the river of the same name; and the Nantucket Shoals Light-Vessel, the first light-

ship passed on the journey from this country to North America. Each vessel is moored off the coast at some danger point near a harbour entrance; each is equipped with wireless transmitter as well as with an instrument for generating powerful submarine signals, and these latter can be picked up at distances of 10 or 20 miles by vessels suitably equipped. It is the latter apparatus which is to be considered in some detail.

### Radio Beacons.

Before doing so, however, it may be as well to make it clear that there are many other light-vessels in operation at the present time anchored off the coasts, capable of performing the duty of "wireless" lighthouses. They are generally termed "Radio Beacons," and their function is to send out broadcast, on a regular schedule, distinctive radio fog signals which can be utilised by ships equipped with direction finders to locate their position. But it is recognised that when taking bearings in this way near the coast, various errors, in part due to intervening land, have to be provided for and guarded against, and only as time progresses, bad and good arcs are being mapped out for the guidance of mariners.



**Synchronous Signalling by Sound and Wireless.—**

Seeing that sound waves are conveyed in a very uncertain way through the atmosphere, the question naturally arises, Why not use the ocean of water as the connecting link of communication between ship and coast station or beacon?

At this juncture it might be mentioned that some years ago the experiment was tried at Point Judith Light-Vessel (at the entrance to New York Harbour) of giving the mariner a warning of his approach to the anchored light-vessel solely by means of wireless. As in the case of

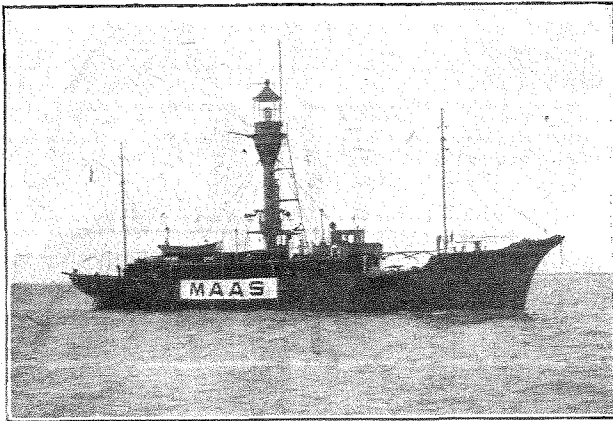

The Dutch lightship at the entrance to the River Maas, which is equipped with wireless and submarine sound ranging apparatus.

the present-day radio beacon stations, signals were sent out automatically, but at Point Judith, instead of using a code message, a gramophone spoke into the telephone transmitter and repeated the name of the station at regular intervals. After every few repetitions of the station name, a much softer voice said: "You are getting nearer, take care." Such an arrangement may be regarded as a rough method of warning the mariner of his distance from danger, but the method in practice does not seem to have been entirely successful, and after a few trials was discontinued.

Perhaps one of the most useful purposes of radio beacons is that of serving as a "leading mark" to enable a vessel to make for a lightship or pass by the same ship anchored in a harbour entrance.

**Advantages of Submarine Signalling.**

The purpose of the submarine signals is to enable the seaman to estimate his distance from the lightship with reasonable accuracy. Compared with sound waves sent through the atmosphere, waves propagated under water have two great advantages. In the first place, a submarine signal can be heard at a much greater distance than a sound of the same initial intensity transmitted through the air. It is true that the speed of under-water signals is not strictly constant; the speed depends on the temperature, density, and salinity of the water through which it travels. On the other hand, sound is conveyed in a very capricious way through the air, a disadvantage which does not occur with under-water signals.

The history of submarine signalling is a brief one, although it dates back very nearly a hundred years to the

classical experiments of Colladon and Sturm, who listened to the striking of a submerged bell across a stretch of water in Lake Geneva. We know, too, that the pearl divers of Ceylon still communicate with one another when under water by striking two oyster shells together. Until recently, however, nothing practical had resulted from the early experimental work carried out in 1827 in Lake Geneva. The most serious natural obstacle to be contended with and to be overcome was the fact that water is almost incompressible. Now, since a submarine sound wave is a compressional wave in the medium through which it is transmitted, it follows that any apparatus which is to send submarine waves over considerable distances must be capable of exerting a very great force.

The practical problem has been studied for many years by Professor R. A. Fessenden<sup>1</sup>, and his latest form of oscillator is capable of generating these powerful under-water waves.

The apparatus consists of a powerful magnetic oscillator, comprising a strong electro-magnet surrounding a central core. The moving part is the copper tube which acts as a closed secondary to the core winding, and is placed in the air gap between the core and the magnet. The ring magnet is energised by the coil, and produces an intense magnetic flux, there being more than 15,000 lines to the square centimetre of cross-section. The path of the magnetic flux is from one pole of the ring magnet across the air gap (which contains the upper part of the vibrating copper tube), then through the central stationary armature, across the other air gap to the lower pole face of the ring magnet, and back to the upper pole face through the yoke of the magnet. For signalling purposes the

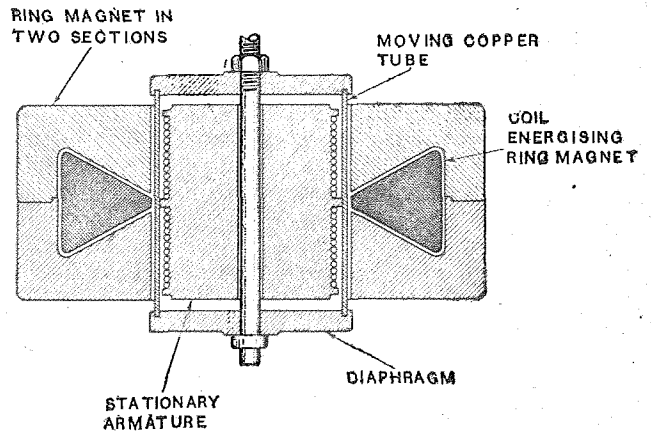

A copper tube clamped between cast iron end plates serves as a diaphragm for setting up sound waves in the water. Currents are induced in the tube by the winding round the centre core and cause it to move in the strong field of the ring magnet.

central stationary armature is excited by a powerful alternating current at a frequency of about 500 cycles, and continuous current for energising the outer magnet-ring is

<sup>1</sup> Prof. Fessenden has been identified with radio science since its earliest beginnings, having carried out the first experiments in radio telegraphy for the United States Weather Bureau (January 19th, 1900). His name is always associated with the Inductor Type of Alternator (non-revolving field type) for generating H.F. currents. Several patents in submarine signalling are due to him.

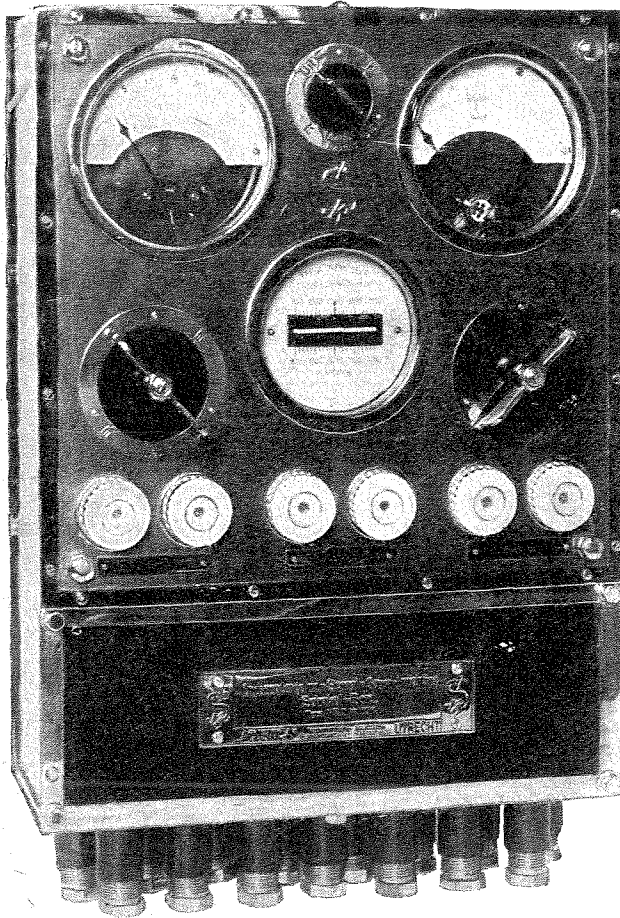

Power control switch board of the motor generator from which alternating current of high periodicity is obtained for feeding the submarine oscillator.

usually obtained from a belt-driven 4 kw. dynamo. Alternating current at 500 cycles is derived from a motor generator connected up with the output of this dynamo. When the alternating signalling current is applied to the inner core windings, it induces an alternating current in the copper tube, which, being free to move, vibrates backwards and forwards in the field set up by the outer polarising magnet. This motion gives rise to a rapid in-and-out movement of the metallic diaphragm which is secured to the tube. This diaphragm, which is made of steel  $\frac{3}{8}$  in. thick, forms the base of the oscillator. The whole apparatus must be lowered overboard to a depth of 20ft. or 25ft.; the diaphragm is in direct contact with the water. When receiving, however, the diaphragm may form part of the side of the ship.

In the latest form of oscillator intended for use on light-vessels (as distinct from the old Navy type), the steel diaphragm and copper tube weigh approximately 100 lb. The moving parts are thus seen to be of very substantial proportions, which is necessary in order to afford sufficient mechanical strength to withstand the stresses put upon them in the work of compressing the water. Moreover, the inertia of the moving parts has to be overcome in the design in such a way that a musical note having a

pitch of about 500 a second may be produced. This is absolutely necessary if extraneous noises, such as the lapping of the water against the ship's side, is to over-read in the course of signalling. Now, supposing it is required to signal at the rate of 20 words a minute, and we will take the average word to consist of 5 letters, and the average letter to have a length equivalent to 7 dots of the Morse code. This means that the apparatus must be capable of making 700 dots a minute, or a single dot in something less than one-tenth of a second. So that whatever device is used, it must be capable of producing at least 100 compressional waves in a single second. We thus see that the forces of acceleration necessitated in the moving

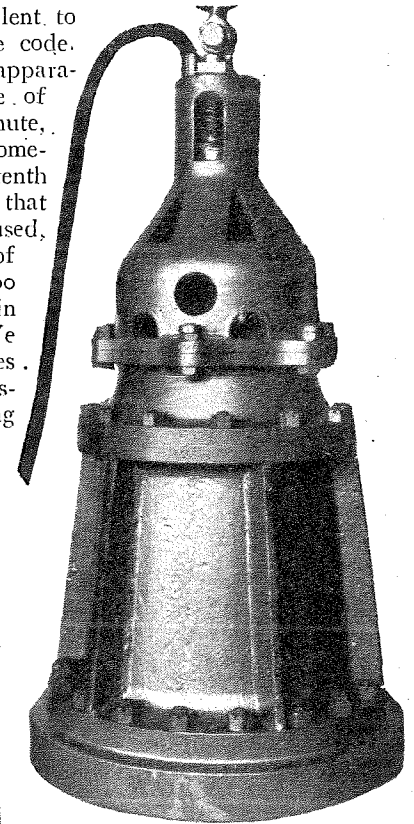

Types of oscillators which are lowered over the ship's side to a depth of about 20 feet and emit powerful sound waves through the water, which can be detected up to a distance of about 30 miles.

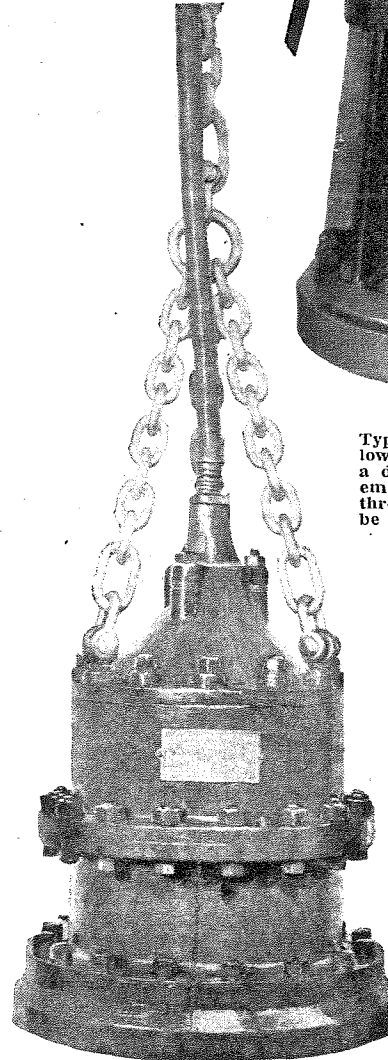

parts are of a very powerful character; while if speech is to be attempted the rapid in-and-out motion of the diaphragm must give rise to several thousand compressional waves a second. Actually, the diaphragm (which, it will be realised, is in direct contact with the water, whichever method is used) must be made to start from rest,

**Synchronous Signalling by Sound and Wireless.—**

accelerate until it attains its highest velocity, and then come to rest again in about the one-thousandth part of a second if signalling at 20 words a minute is required.

Considering the substantial design employed and the weight of the moving parts, one would hardly have expected that the oscillator could be used as a sensitive sound receiver. Yet this is so, for sound waves striking against the diaphragm cause the copper tube to vibrate; this movement generates an induced current in the armature windings, which can be made audible through a pair of telephones.

In transmitting an ordinary telegraph key is used, and as the armature has substantially no self-induction, and, moreover, there are no eddy currents produced in the apparatus, there is very little sparking at the contacts of the transmitting key. Messages sent in this way have been received up to distances of quite 30 miles.

Turning now to the practical details of position finding, we see that the seaman who is lost in fog and believes his vessel to be in danger, has to listen for two signals; one of these he receives in the ordinary way on his wireless receiver, the other through a microphone set in a water tank, one on each side of the ship, and, of course, below the water-line. On the transmitting light-vessel both signals are controlled by a small motor-driven code machine containing revolving discs fitted with "dogs" which make contact for the oscillator and radio apparatus at appropriate times. By taking the radio signal as instantaneous and allowing 625 yards (1.486 metres) for each second that the submarine signal is heard after the wireless fog-signal, the mariner knows approximately his distance away. Or it may be arranged for a series of dots to be sent out separated at time intervals of 1.3 second, which amount corresponds to the time taken by the under-water signal to travel a distance of one mile. Thus the number of dots already received when the submarine signal is heard is the distance away the light-vessel in miles. This method obviously dispenses with the necessity of the stop-watch for measuring the time lag of the submarine signal.

The cost of operating such stations is very small; no additional personnel is required, as in foggy weather the master of the light-vessel can put the apparatus into operation by the closing of a single switch. Beyond this

all that is necessary is occasional inspection by a competent officer.

There are one or two things to say in conclusion. It must not be taken for granted that all forms of siren for generating air signals fail, but it is well known how unreliable these air signals are, and at no time more so than in fog just when they are most urgently required. But one outstanding advantage is that submarine signals can be received in the wireless cabin through the ordinary double ear-piece head telephones, one ear being connected to the radio and the other to the sound receiver; aural signals must be received in the open air. When used in conjunction with wireless direction finders, the submarine signals afford additional means of checking readings and overcoming the difficulties due to bad arcs. For the best results, however, it is sometimes necessary for the ship desiring information to slacken speed so as to get rid of extraneous noises—throbbing of the ship's engines, etc.; but this is hardly a serious disadvantage in bad or foggy weather. The working distances possible at the present time are not great, but recent experiments carried out by the French Hydrographic Service indicate that by firing small depth charges of the order of 1 kilogram, signals can be heard under water over 200 miles. This means that a ship can approximately locate itself when half a day's journey from port or coast. It remains to add that icebergs can be located by the same apparatus, the time of arrival of the submarine wave reflected from the iceberg being noted, a

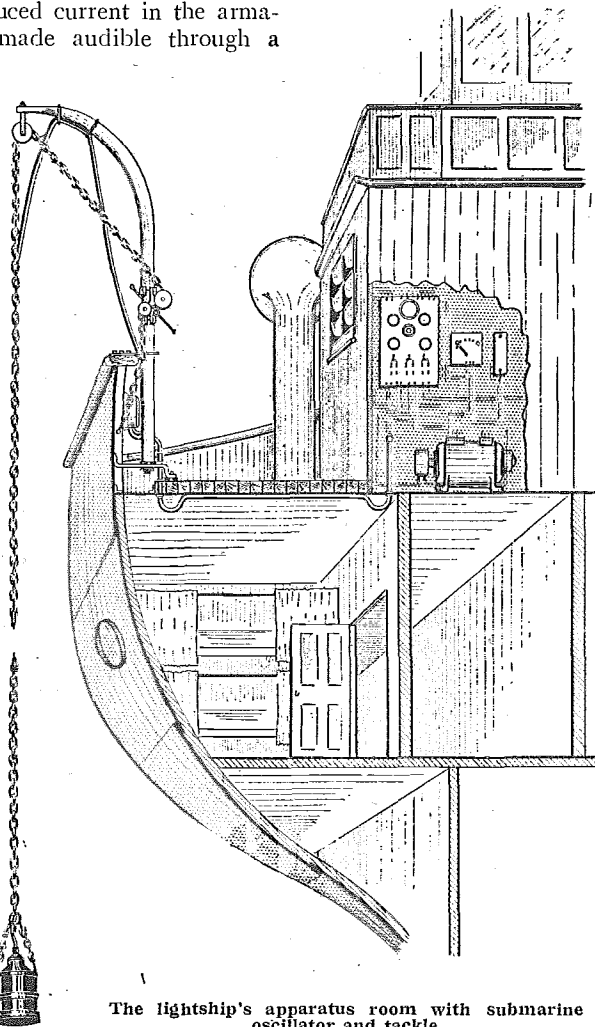

The lightship's apparatus room with submarine oscillator and tackle.

method which is employed by the American Navy in the North Atlantic for keeping watch on icebergs drifting southwards towards the steamship routes.

But whatever the future may hold in store in the way of minor improvements in this new form of signalling distances, it seems necessary to explore and make known to the mariner every possible channel which will tend to make the navigation of his vessel safer and easier. For not only is this going to make sea voyages safer for the traveller, but ultimately it will cheapen a form of transport which, as we know, requires but a very small expenditure of energy compared with other forms of transport, but where risk and delay due to fog adds unduly to the cost.

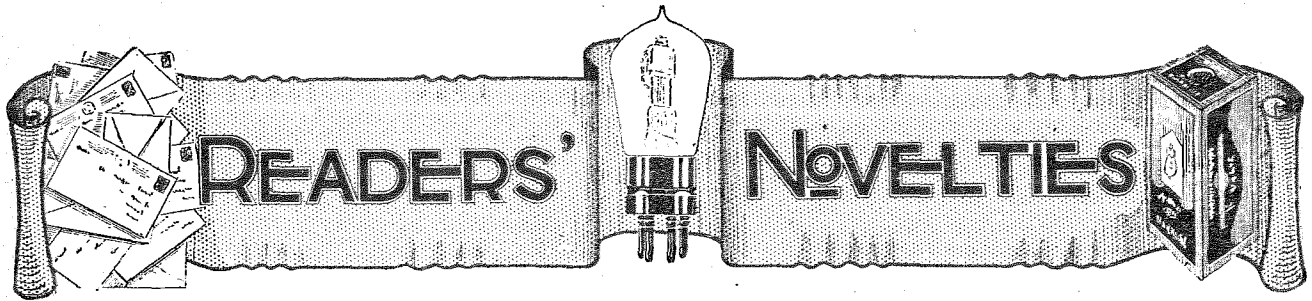

A Section Devoted to New Ideas and Practical Devices.

**A SWITCH FOR BASKET COIL TAPPINGS.**

The coil is wound on a rigid former of insulating material which is mounted to rotate on a spindle passing through the centre at right angles to the plane of the coil. The former may be cut from sheet ebonite or hard

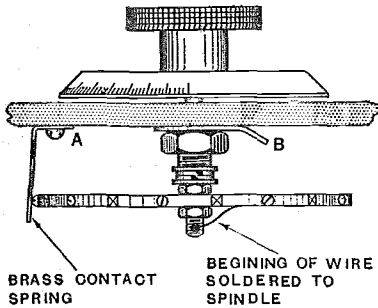

Tapping a basket coil by means of contact screws around its periphery. The use of tapping leads is avoided.

wood about  $\frac{3}{16}$  in. in thickness, and the number of slots may be adjusted within limits to conform to the number of tappings on the coil. It is important to remember that an odd number of slots must always be used.

The inside end of the coil should be connected to the spindle and the outer end, and the intermediate tappings to round-headed screws in the periphery of the coil former. Contact with these screws is picked up through the medium of a suitably shaped spring fixed to the base of the instrument.—C. H.

o o o o

**AN EFFICIENT AERIAL INSULATOR.**

The surface insulation of an aerial insulator may be very considerably increased by fitting over it a length of glass tubing of suitable diameter.

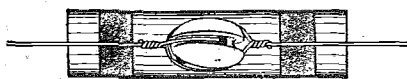

Increasing the leakage surface of an egg insulator.

A 20

The tubing may be obtained ready cut to the required length from any dealer in chemical glassware. Suitable corks or rubber bungs may be obtained from the same source, and should be fitted in the manner indicated in the diagram.

The glass tubing is not subjected to the strain imposed by the weight of the aerial. This is carried by the egg insulator, which is kept dry by the tube.—G. W. B.

o o o o

**REVERSING REACTION CONNECTIONS.**

A reversing switch for the reaction connections is unnecessary when the reaction coil is coupled only to one other coil such as the A.T.I., and if a three-coil holder is available.

The aerial coil should occupy the centre coil holder while the reaction coil may be plugged into either of the movable coil holders on either side.

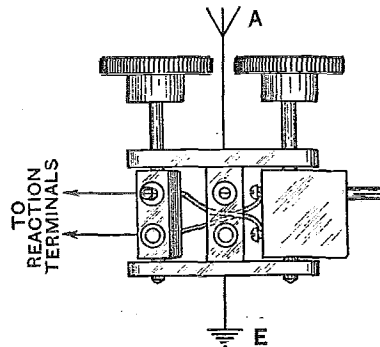

Alternative reaction sockets for reversing the direction of coupling.

If these coil holders are cross connected, it will be possible to reverse reaction by moving the reaction coil from one coil holder to the other.—C. J. N.

o o o o

**A HIGH-TENSION SAFETY SWITCH.**

Leakage currents due to faulty insulation very frequently account for many hours of the life of a high-tension battery which would otherwise

be capable of giving useful service. A switch in the H.T. battery circuit obviates this trouble if it is used, but may be neglected when the receiver is hurriedly switched off.

A relay actuated by the filament current and connected according to the circuit given in the diagram makes

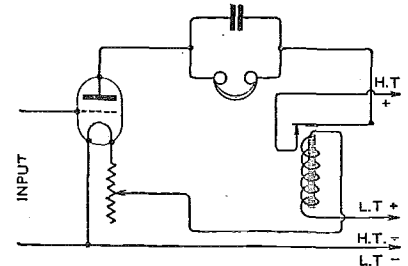

A relay in the filament circuit will automatically control the H.T. battery circuit.

the operation of the H.T. switch automatic. Besides preventing leakage currents when the set is not in use, it also safeguards the filament when a valve is being inserted. Until the sockets are inserted correctly no filament current will pass, and the H.T. battery will remain disconnected.—E. H. L.

o o o o

**SQUARING EBONITE PANELS.**

The edges of ebonite panels that have been cut by hand generally require to be squared up before they can be used. The process of filing down the edges in the vice is at all times tedious, and can present considerable difficulty unless a large file is available, and one has had plenty of practice in the art of filing. The building of a squaring board is well worth the trouble, therefore, even if called into use only occasionally.

A perfectly flat piece of wood with at least one straight edge is first required. A small drawing-board is excellent for this purpose, and well worth the extra expense. At one end

of the board and at right angles to the longest edge is screwed a wooden stop against which to hold the panel. A "rubber" about 8in. in length is now built up out of two straight pieces of wood, and a strip of coarse glass paper is secured to the edge with glue. The panel to be squared is pushed firmly against the stop and moved a little at a time towards the edge of the board as the "rubber" takes off the highest points of the rough edge. Several "rubbers" may be prepared with different grades of glass-paper in order that a smooth finish may be imparted to the edges. —W. A. C.

o o o o

**A VARIABLE FILAMENT RESISTANCE.**

A variable resistance of the compressed carbon type is very easy to construct and is capable of giving a fine control of filament temperature.

A cotton reel of rather large size is obtained, and the centre hole enlarged to take an ordinary arc lamp carbon. Sections of the carbon rod are cut about 1/8 in. in thickness and smoothed down on a flat sheet of fine glass paper. Care should be taken to keep the surfaces as far as possible parallel. The bottom end of the cotton reel is closed with a metal plate from which one connection is taken. The other connection is taken from a metal strip threaded to take the compression screw. This strip is screwed to the top of the cotton reel after inserting a suitable number of

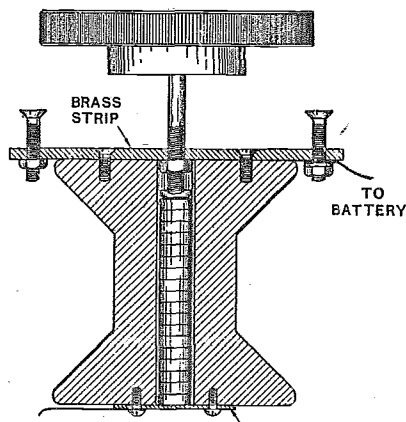

Construction of a carbon pellet type variable resistance.

carbon elements in the central hole. If the carbon rod is taken from a dry cell the brass cap used to make contact at the end may be inverted and used to protect the upper elements

11

from damage by the compression screw.—J. H. L.

o o o o

**AN EFFICIENT KNIFE SWITCH CONTACT.**

Faulty contact in a knife switch can generally be traced to the bearing bracket carrying the blade of the switch. The spring contacts, if pressed from good phosphor bronze last indefinitely and always make firm contact with the blade, but the centre bearings of many switches at present on the market are riveted together and soon wear loose. It is quite a simple matter, however, to restore the efficiency of a bearing that has worked loose by the method indicated in the diagram.

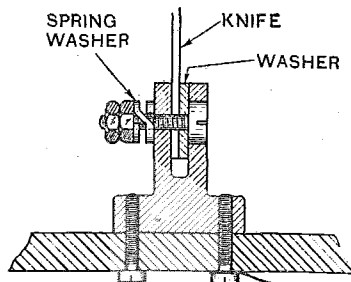

Method of obtaining reliable contact between the lever and bracket of a knife switch.

The rivet is removed with a centre punch after filing off the head and replaced with a nut and bolt. The rivet hole is enlarged on one side to clear the head of the screw and on the other the shank. An ordinary washer is then inserted between the switch blade and the screw head. Constant tension ensuring a good contact is maintained by a spring washer held in position by the back nuts on the screw. Any wear in the bearing is automatically taken up by the spring washer.—S. N. S.

o o o o

**RESISTANCE COUPLING UNIT.**

High-frequency amplifying valves with tuned anode coupling can be easily converted to resistance coupling with the unit illustrated in the accompanying diagram.

A coil plug is provided with spring clips at each side, which are connected to the plug and socket connections. The clips hold an anode resistance of suitable value, which can be made to replace the anode coil merely by plugging the unit into the anode coil holder.

The value of the H.T. battery must be increased and the anode tuning

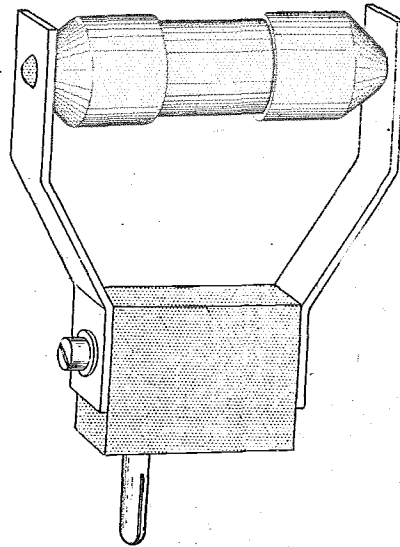

Holder for substituting resistance for inductive intervalve coupling.

condenser must be set at zero or disconnected entirely if it has an appreciable zero capacity.—A. R. O.

o o o o

**TERMINALS FOR EXPERIMENTAL COILS.**

When testing unmounted coils in the coil holder of a finished receiver, it is convenient to make use of terminals specially fitted with pegs and sockets for insertion in the coil holders.

These terminals if kept handy will greatly facilitate the work of testing the new coils before they are mounted, and there will be far less

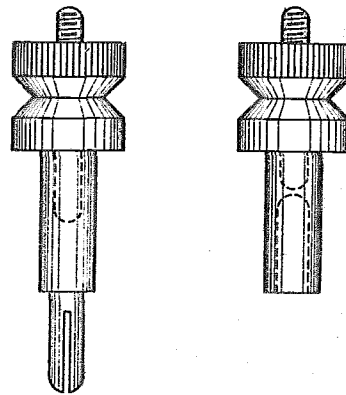

Plug and socket terminals for testing unmounted coils.

likelihood of wires becoming disconnected or short-circuited than there is with the more usual method of packing the wire into the sockets with match stalks.—W. R. H.

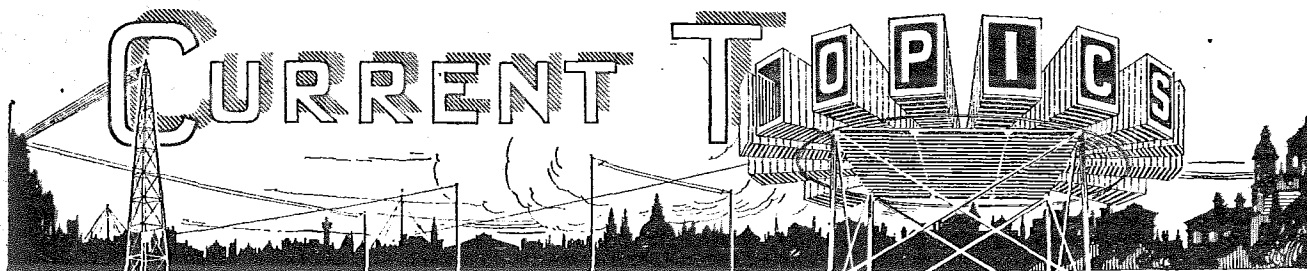

## Events of the Week in Brief Review.

### AFTERNOON BROADCASTING.

Afternoon programmes are to be resumed at the Radio Paris broadcasting station.

○○○○

### ATLANTIC CROSSED WITH INDOOR AERIAL.

M. Pierre Louis, an Orleans amateur, has succeeded in transmitting 20-metre signals to America while using an indoor aerial only 13 feet long.

○○○○

### ESPERANTO IN SPAIN.

Lessons in Esperanto are now included in the programmes from the Barcelona broadcasting station.

○○○○

### WIRELESS ON RUSSIAN RAILWAYS.

The Russian railway authorities appear to show greater enthusiasm in the possibilities of wireless for train working than is evident in this country. According to a message from Ekaterininsk, a plan has been prepared for the installation of a powerful broadcasting station at Ekaterininsk to serve nine receiving stations at various points along the railway route.

It is understood that trains will be fitted with broadcast receivers.

### LICENSED AND UNLICENSED.

The number of broadcast receiving licences in force on April 30th was approximately 1,356,000, and the total revenue collected from January 1st to April 30th was in the neighbourhood of £268,000.

Viscount Wolmer stated in the House of Commons that there were no statistics showing the number of unlicensed sets in existence.

○○○○

### SOUTHERNMOST WIRELESS STATION.

If and when you pick up the call sign LRT, you will be in touch with the world's most southerly wireless station. This is in process of erection in the South Orkney Islands, where the Argentine Government maintains a meteorological observatory.

○○○○

### NEW MARCONI MANAGER.

Mr. Frederick Sandland Hayburn has been appointed manager of the Marconi International Marine Communication Company. Mr. Hayburn has been associated with the Company for twenty-one years.

○○○○

### WIRELESS IN LEICESTER EXHIBITION.

Wireless is to be a prominent feature of an "All Electric" Exhibition to be held in Leicester next October.

### LIGHTHOUSE WIRELESS.

The Irish Free State Minister of Posts and Telegraphs announces that proposals are afoot to install wireless on the Tuskar lighthouse for communication with the mainland.

○○○○

### WHAT IS AN "AMATEUR"?

An interesting question has been raised by Mr. Kenyon Secretan (5LF), who has just returned to England after conducting short wave experiments at sea. In a newspaper report Mr. Secretan was referred to as "one of our foremost amateur wireless engineers," but he takes exception to this description, stating that he lost his amateur status many years ago.

Many so-called "amateurs" to-day are actively engaged in the wireless profession. Their experiments, however, are carried out in their spare time. Does this fact entitle them to be called "amateurs"?

○○○○

### AIRCRAFT INSTRUCTIONS BY WIRELESS.

Leaving Croydon with a passenger on Sunday, May 24th, Captain F. L. Barnard, the famous airman, had to proceed northward without knowing his precise destination. His objective was Man-

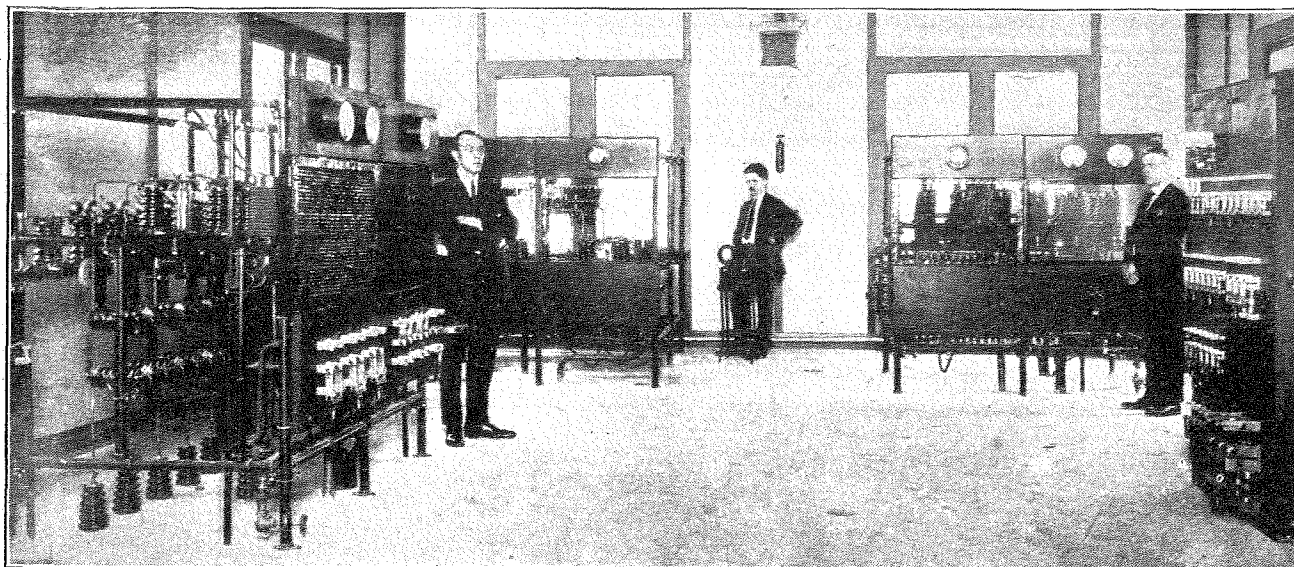

**KDKA's TRANSMITTING ROOM.** Engineers of the famous Pittsburg Broadcasting Station are here seen in the transmitting room, which contains the oscillator, modulator and rectifier panels.

chester, but owing to the absence of Sunday staffs at the aerodromes surrounding the city, arrangements had to be made during the flight. Trunk telephone calls soon summoned a staff at one of the aerodromes, and Captain Barnard was communicated with by wireless, and given instructions where to land.

o o o o

**WIRELESS BILL DROPPED.**

General satisfaction was felt at the Prime Minister's announcement on May 25th that the Government had decided not to proceed with the Wireless Telegraphy and Signalling Bill this session. The question will again be raised at the general broadcasting enquiry to be held towards the close of the year.

o o o o

**10-METRE TRANSMISSIONS FROM ITALY.**

Transmissions on 10 metres are included in the latest schedule issued by IIRG, the experimental station of the *Radio Giornale*, Milan, Italy.

Tests take place every Sunday as follows:—14.00 G.M.T.—10 metres; 15.00 G.M.T.—20 metres; 16.00 and 17.00 G.M.T.—45 metres. The power input is 100 watts.

Reports on these transmissions are warmly welcomed, and should be addressed to Signor Ernesto Montù, *Il Radiogiornale*, Viale Mains N.9, Milan (13), Italy.

o o o o

**EXIT THE ARC?**

French amateurs are joyfully anticipating the time when the arc transmitter at the Eiffel Tower station will be dismantled. According to reports the new transmitter to be installed at FL may supplant the arc installation which has irritated French amateurs for so many years. Operating on a wavelength of 1,700 metres, the new transmitter has a power of 25 kilowatts.

o o o o

**B.C.L.'S AND SHIP DISTURBANCE.**

Several hundred broadcast listeners in the neighbourhood of Sound Beach, Connecticut, have forwarded a resolution of thanks to Charles J. Pannill, general manager of the Independent Wireless



A group of American and Canadian amateurs who recently paid a visit to the works of the Mullard Radio Valve Company, Ltd.

10

Telegraph Co., for taking a definite step to overcome ship interference with broadcasting.

Being aware of the disturbance caused by ships working on the waveband assigned by the Department of Commerce, the Independent Telegraph Co. raised the wavelengths of its New London and ship stations. A great improvement has resulted, to the delight of the B.C.L.'s.

o o o o

**POLISH COMMERCIAL STATION TO BROADCAST.**

Owing to the inadequacy of the Warsaw broadcasting station to serve the whole of Poland, it has been decided to make use of the commercial wireless station at Cracow for relaying Warsaw's programmes. In time this station may also transmit its own programmes.

o o o o

**THE ARMY MANŒUVRES.**

Wireless is to play an important rôle in the forthcoming Army manœuvres. The two opposing forces will be known respectively as the Eastern Army and the Western Army, and both will be directed extensively by wireless telegraphy and telephony. Considerable use will be made of aircraft radio.

o o o o

**BROADCASTING AND THE PRESS.**

Yet another indication of the widespread interest in matters relating to broadcasting is afforded by *The Times*, which now includes a daily section containing special articles and items of news concerning broadcasting topics.

*The Morning Post* publishes musical criticisms of broadcast performances.

o o o o

**THE FOIRE DE PARIS.**

Radio exhibits are a striking feature of the Foire de Paris, which opened its doors on May 9th. Although at the inaugural ceremony many of the buildings were incomplete and closed to the public, the Hall of Electricity, containing the wireless section, was finished and ready to receive the huge crowd which immediately visited it.

The wireless stands are arranged in four long aisles, and exhibit a range of articles from the latest catwhisker to a half-kilowatt transmitter. Portable sets are prominent, and much attention is given to novelties in the shape of ingenious variable condensers and low capacity basket coils.

The paramount impression to be gained from the show is that the French manufacturers have made considerable progress during the past year in the mechanical construction and design of sets.

o o o o

**HETERODYNE TRANSMISSION.**

With reference to the letter under the above heading in the *Wireless World* of May 20th, "R. E." sends an additional communication pointing out that heterodyne transmission would cause interference, and that the only admissible form of transmission is C.W. interrupted the proper number of times per second, e.g., 370 times a second for the note F#.



H.M. The King of the Belgians photographed at the entrance to the "Amplion" Pavilion at the Brussels Commercial Fair.

**ITEMS FROM THE TRADE.**

A swimming club has recently been formed by members of the staff of Messrs. A. J. Dew & Co., the well-known wholesale and export wireless merchants. The club meets weekly at the Marylebone Baths.

o o o o

An attractive showcard has been issued dealing with the A.J.S. loud-speaker. The firm makes a speciality of horns to match any wood ranging from ebony, rosewood and mahogany to the lightest oak.

o o o o

The Martin-Copeland Co., of Providence, U.S.A., whose sole British representatives are the Electrical Equipment & Carbon Co., Ltd., have decided to withdraw the trade mark "MAR-CO" for their wireless apparatus in this country and will use the British trade mark "TELWAVE."

o o o o

Users of the McMichael High Frequency Transformers will be interested in the firm's latest device, known as the H.F. Reactor. It has for its purpose the application of reaction to a receiving circuit via the H.F. transformer instead of to the aerial coil.

o o o o

The Rugby Challenge Cup presented by Messrs. E. Hulton & Co., Ltd., Manchester, for the Broughton Rangers Works competition has been won by the staff team of The Chloride Electrical Storage Co.'s works at Clifton Junction. In the winning match the Manchester Ship Canal No. 9 Dock team was beaten by 8 points to 5.

o o o o

The House of Graham is justly proud of the fact that their public address equipment and Amplion loud-speakers were used at St. Peter's, Rome, on the occasion of the canonisation of Sister Teresa. The whole service, held by His Holiness the Pope, was reproduced with perfect clarity for the benefit of the thousands of people who congregated to observe the ceremony.

# EUROPEAN REGULAR

The following tables show at a glance the times of transmissions of the principal European Broadcasting Stations. The tables are arranged in order of wavelength and abbreviations are used to show the style of programme during the transmissions. A list of these abbreviations are given at the top of the opposite page.

The transmissions shown in the tables are at the times they can be heard in this country. (Summer time.)

STATION	CALL SIGN	W/L	9 <sup>A.M.</sup> 15 30 45	10 15 30 45	11 15 30 45	12 <sup>NOON</sup> 15 30 45	1 15 30 45	2 15 30
PARIS, EIFFEL TOWER	FL	2650	1	T	T	M	N	
RADIO PARIS	CFR	1780	2				<sup>SC</sup> CNM	NM
CHELMSFORD	5XX	1600	3					
VIENNA (Radio Wien)		530	4	M		<sup>SC</sup> TuTh S C		
ZURICH (Hongg)		515	5				<sup>SC</sup> TNM W	
BERLIN (Voxhaus)		505	6	<sup>SC</sup> M		C L		
ABERDEEN	2BD	495	7			<sup>SC</sup> W C		
MUNICH		485	8			<sup>SC</sup> M		
SWANSEA (Relay)	5SX	485	9					
PRAGUE (Strasnice)		475	10			<sup>SC</sup> M		
BIRMINGHAM	51T	475	11					
FRANKFORT		470	12			N		
KONIGSBERG		463	13	<sup>SC</sup> C				
PARIS, ECOLE SUP. des P. & T.		458	14					<sup>SC</sup> Th L
LEIPZIG		454	15	<sup>SC</sup> C		M N		
STUTTGART		443	16			<sup>SC</sup> Rel		
BELFAST	2BE	435	17			<sup>SC</sup> Tu Th F C		
ROME (U.R.I.)	ICD	425	18			<sup>SC</sup> Rel	N	
GLASGOW	5SC	420	19			<sup>SC</sup> W C		
BRESLAU		418	20	<sup>SC</sup> C		C		T N
MUNSTER		410	21	<sup>SC</sup> C		<sup>SC</sup> N C	N	
NEWCASTLE	5NO	400	22			<sup>SC</sup> Tu Th C		
HAMBURG		395	23	<sup>SC</sup> T N		<sup>SC</sup> L	M N	
MADRID	RI	392	24					N C
BOURNEMOUTH	6BM	385	25					
MANCHESTER	2ZY	375	26					<sup>SC</sup> Th C
LONDON	2LO	365	27					<sup>SC</sup> TuTh F C
CARDIFF	5WA	351	28					
LEEDS-BRADFORD (R'y)2LS		346	29					C
PARIS (Petit Parisien)		345	30					
PLYMOUTH (Relay)	5PY	335	31			<sup>SC</sup> M W C		
HULL (Relay)	6KH	335	32					
DUNDEE (Relay)	2DE	331	33					
NOTTINGHAM (Relay)	5NG	328	34					C
EDINBURGH (Relay)	2EH	328	35			<sup>SC</sup> Tu Th C		
LIVERPOOL (Relay)	6LV	315	36			<sup>SC</sup> M W C		
STOKE-ON-TRENT (Relay)6ST		306	37					<sup>SC</sup> M W F S C
SHEFFIELD (Relay)	6FL	301	38					C
BRUSSELS	SBR	265	39					





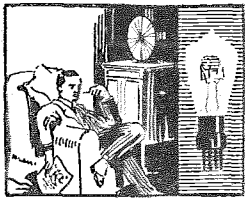

# NEWS FROM THE CLUBS:

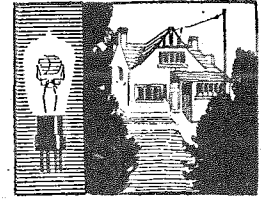

Secretaries of Local Clubs are invited to send in for publication club news of general interest.

All photographs published will be paid for.

## The Golders Green and Hendon Radio Society.

An interesting evening was spent on May 20th, when Mr. W. J. T. Crewe, the hon. secretary, delivered his lecture on "Mast and Aerial Equipment." The lecture stimulated a lively discussion, and it was gratifying to note that a large number of hitherto shy members availed themselves of the opportunity of airing their views.

The Society has arranged a field day for Sunday, June 7th, at Mill Hill, when experiments on a number of wavelengths will be tried out. As the A.R.R.L. has been informed, it is hoped that on this occasion some American amateurs will be worked in daylight. A good deal of detail work has been done to make the outing a success both from the advanced worker's standpoint and that of the B.C.L.

Full particulars concerning membership may be obtained from the hon. secretary, Mr. W. J. T. Crewe, 111, Prince's Park Avenue, Golders Green, N.W.11.

o o o o

## Norwich and District Radio Society.

The final meeting of the winter session was held on May 19th, when another of the local members, Mr. Charles Gates, gave an interesting lecture on telephones.

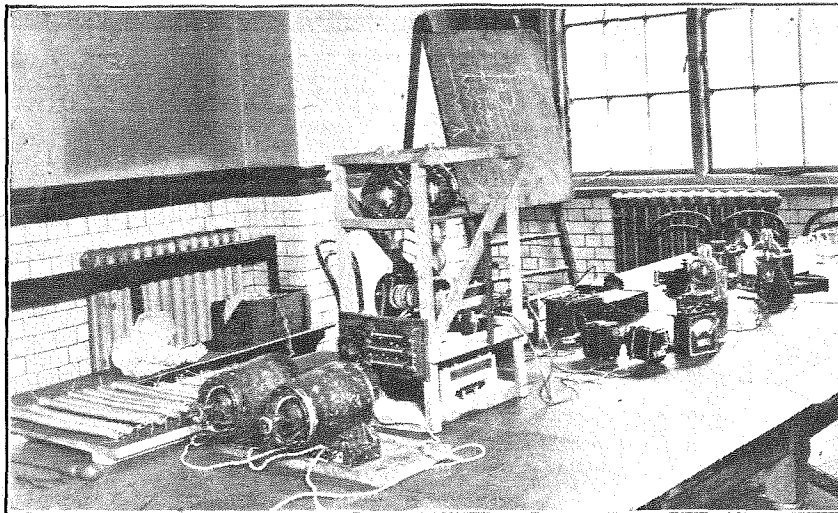

**AN EXPERIMENTAL DISPLAY.** This interesting array of apparatus was demonstrated by Mr. F. H. Haynes before the Eastern Metropolitan Group Radio Lecture Society on May 18th. The small A.C. generators in the foreground were used for filament heating and plate current supply in conjunction with the rectifier valves shown in the wooden framework. Two 100 watt M.O. valves were operated by the high voltage current delivered from the rectifying equipment.

## FORTHCOMING EVENTS.

### WEDNESDAY, JUNE 3rd.

*Institution of Electrical Engineers (Wireless Section).—At 6 p.m. (light refreshments at 5.30). At the Institution, Savoy Place, W.C.2. Lecture: "The Effect of Wave Damping in Radio Signal Measurements." By Dr. R. L. Smith-Rose, M.Sc.*  
*Golders Green and Hendon Radio Society.—At 8 p.m. At the Club House, Willfield Way. Lecture by Capt. K. E. Hartridge (5CB).*

### THURSDAY, JUNE 4th.

*Kensington Radio Society.—At 8.30 p.m. Talk on: "Inductance Capacity and Resistance in Oscillatory Circuits." By Mr. L. P. Fogarty.*

### SUNDAY, JUNE 7th.

*Golders Green and Hendon Radio Society.—Field day.*

### SATURDAY, JUNE 13th.

*North Middlesex Wireless Club.—Field day.*

Mr. Gates first dealt with the historical aspect of the progress of the telephone, and later explained in detail its mode of working, illustrating his remarks by the aid of blackboard drawings.

This meeting concludes the indoor gatherings until the autumn, but it is hoped to arrange something of an outdoor nature during the summer in order to afford members an opportunity of meeting together.

## North Middlesex Wireless Club.

A very successful demonstration of recording wireless signals was given by Mr. J. Bray on May 13th.

Mr. Bray's apparatus was, with the exception of a Weston relay, constructed by himself with odds and ends. In the course of his searches in his "junk" boxes he found and requisitioned such things as a disused phonograph motor and an electric bell, with a gramophone record as a support for the tape. These, together with some spare clock and Meccano wheels, constituted the essentials of the recorder. The instrument was of the siphon type, and during the evening recorded excellently some automatic transmissions of high speed, besides the ordinary hand-sent Morse.

The club receiving panel was brought into service to supply the signals and connected with the recorder through a transformer, a crystal detector being used as a rectifier.

Hon. secretary, Mr. H. A. Green, 100, Pellatt Grove, Wood Green, N.22.

o o o o

## Ilford and District Radio Society.

Tuesday, May 12th, was the occasion of an address by the President, Mr. J. E. Nickless. In dealing with the progress of the society during the past year he mentioned the very fine lectures by representatives from, among others, Messrs. Fullers, the Edison Swan Electric Co., and Alfred Graham and Co., and the address by Capt. P. P. Eckersley, of the B.B.C.

During the course of a brief *résumé* of the progress in the radio world he recommended the more general use of the Super-heterodyne receiver.

Later in the evening an auction of the Society's surplus apparatus was conducted by Mr. Aston J. Cooper.

Hon. secretary, Mr. F. W. Gedge, 157, High Rd., Ilford.

o o o o

## Radio Society of Highgate.

In his lecture on "The Valve Voltmeter" on May 14th, Mr. G. Sutton, B.Sc., gave a careful description of the various measurements which could be carried out with this useful instrument, and outlined the improvements which had been effected on the original type.

By means of a final survey of the various instruments used in H.F. measurements Mr. Sutton showed that the valve voltmeter is more accurate and useful than any other single instrument.

Hon. secretary, Mr. F. J. W. Squire, 31, Harvey Road, Hornsey, N.8.

# VALVES WE HAVE TESTED.

## The B.T.H. B3 and B7.

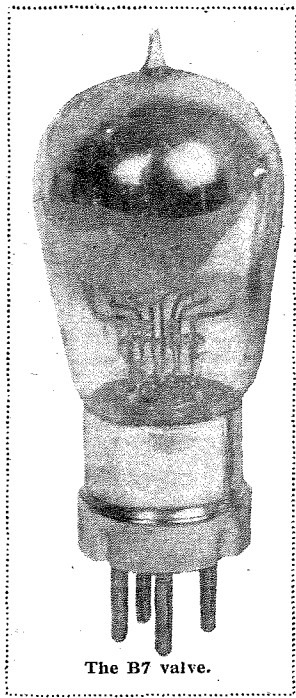

The B7 valve.

WE present to our readers this week the results of tests performed on two valves by the B.T.H. Co., Ltd.—the B3 and the B7. Both types are fitted with dull emitting filaments, but these differ one from the other in that the former operates on low voltage, and the latter on low current.

### The B7.

We deal in detail with the latter valve first. The B7 is a small power amplifying valve fitted with a 60-

milliamperere filament. This is hairpin shaped, the grid and anode being of the flattened form adopted in many modern valves. The filament appears to be on the short side, extending along about two-thirds, or even less, of the grid, and at first sight the reason for this does not seem apparent.

The maker's rating for the B7 is as follows: Filament volts, 6.0; filament current, 0.06 ampere; plate voltage, 40-120.

### High Filament Efficiency.

The emission obtained from these small filaments is really remarkable, and, in the case of the valve under review, reaches a value of 23.5 milliamperes at full voltage, representing an efficiency of 61 milliamperes per watt.

The characteristics of the B7 are quite good, and show an amplification factor of 7, with an impedance falling to 15,000 ohms at full plate potential.

At one time the use of power amplifying valves was, to a great extent, limited, due to the heavy filament consumption then required, but the advent of such valves as that under test brings the class within the reach even of those devotees who, either for preference or necessity, use dry cells for filament heating.

### B7.

The B.T.H. Co., Ltd.

Filament Volts, 6. Filament Current, .064 ampere.  
Emission (total), Milliamperes 23.5. Filament Efficiency, 61 milliamperes per watt.

Plate Volts.	Plate Current, Grid at Zero.	Grid Bias.	Plate <sup>1</sup> Current, Milliamps.	Amplification Factor.	Plate Impedance, Ohms.
40	0.8	-1	0.55	7.55	25,000
60	1.72	-2	1.00	7.0	18,000
80	3.04	-3	1.62	7.0	16,700
100	4.55	-5	1.9	7.0	15,300
120	6.00	-7	2.25	7.0	15,000

<sup>1</sup> Plate current when grid is biased to the value in Col. III.

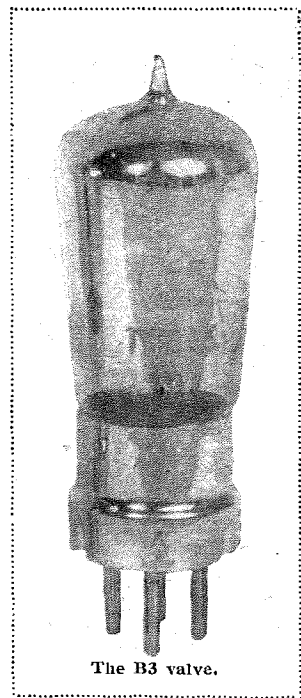

The B3 valve.

The B7 gave every satisfaction under working conditions, and the combinations of plate and grid voltages given in the table will be found a suitable guide for those who wish to use this excellent little valve.

### The B3.

The B3 is the B.T.H. representative in the 2-volt class, and is of the general purpose variety, designed to give equally good performance in any part of a receiving circuit.

The filament is rated at 1.8-2 volts, 0.35 ampere, and at full voltage provides the very liberal emission of 15.7 milliamperes. In consequence, when this valve is being used as a detector or high-frequency amplifier the filament voltage can be considerably reduced. As a matter of fact, in no case, during our practical tests on this valve, did we find it necessary to exceed a filament voltage of 1.8. The amplification factor is of the order most suitable for general purpose use, for it will be remembered that this class of valve must of necessity be a compromise.

When used as a detector or high-frequency amplifier, 40 volts H.T. gave excellent results. In the former case, in common with other dull emitters, it was advisable to connect the grid return lead to the positive side of the filament. The B3 gives good service as the first stage of a L.F. amplifier using 60 or 80 volts on the plate and suitable grid bias.

The B3 can be recommended as a reliable general purpose valve, and with others of its class appeal to the man who prefers to use a single-cell accumulator. It cannot, of course, be termed a small power valve, and for good loud-speaker work it would be advisable to employ a type of valve designed to deal with a larger input in the last stage.

### B3.

The B.T.H. Co., Ltd.

Filament Volts, 1.8. Filament Amperes, .335.  
Emission (total), Milliamperes 15.7. Filament Efficiency, 26 milliamperes per watt.

Plate Volts.	Plate Current, Grid at Zero.	Grid Bias.	Plate <sup>1</sup> Current, Milliamps.	Amplification Factor.	Plate Impedance, Ohms.
20	0.16	0	0.16	8.5	66,000
40	0.57	-1	0.36	8.7	45,000
60	1.09	-2	0.63	8.7	36,500
80	1.78	-3	0.98	8.7	32,000

<sup>1</sup> Plate current when grid is biased to the value of Col. III.

# Interference from Adjacent Aerials.

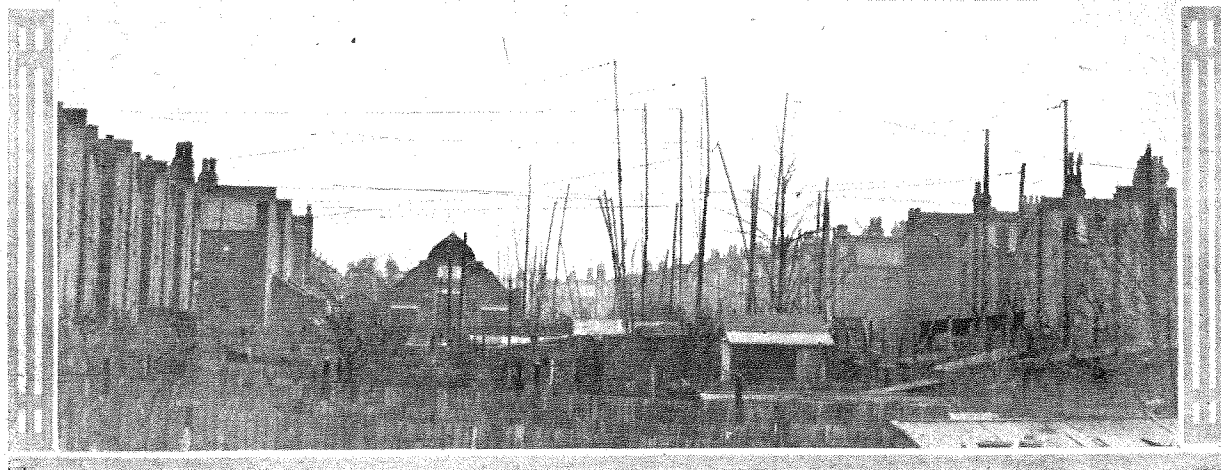

## The Effects on Crystal Set Reception.

By W. H. F. GRIFFITHS.

IT is a well-known fact that many interference "effects" in wireless reception are experienced because of the close proximity of aerials, more especially when they run, roughly, parallel to each other.

These "effects" vary greatly with the type of receiving apparatus associated with the aerials and with the relative heights and radiating properties of the aerials themselves, as well as, to some extent perhaps, the nature of their earth connections. In some cases the owners of crystal sets may suffer a loss of energy by no means inconsiderable, while others may, through the medium of near-by aerials of considerable radiating efficiency, receive an amount of radio-frequency energy very much in excess of that which their own aerial systems would normally receive direct from the transmitting station.

In addition to these signal strengthening and diminution "effects," it is also possible for a reacting valve receiver to suddenly burst into oscillation due to an adjustment having been made to *another* receiver attached to a neighbouring aerial. Again, the open-circuiting, earthing, or tuning of a neighbouring aerial may alter the effective oscillation constant, LC, of a receiving aerial sufficiently to render necessary a tuning readjustment of the latter.

Another, and very objectionable interference effect is that caused by the modulation of the radio-frequency current in a neighbouring aerial by the "more sensitive spot finding" adjustment of a crystal employing a catwhisker. In this latter case the characteristic scraping and metallic ringing of the catwhisker are faithfully reproduced in the receivers associated with neighbouring aerials, and, in cases of extreme proximity, the telephones of the crystal set may modulate in this way suffi-

ciently to reproduce intelligibly in neighbouring receiving sets speech uttered by the wearers of those telephones.

In order to ascertain the degree of interference possible between aerials, more particularly as affecting crystal set reception, the writer has carried out some experiments with aerials in fairly close proximity. Four aerials were used in these experiments, and are enumerated below:—

*No. 1 Aerial.*—Twin "T" aerial, 70ft. long and 30ft. high.

*No. 2 Aerial.*—Single wire aerial, about 30ft. long and of mean height about 18ft. This aerial was about 16ft. away from, and roughly parallel to, aerial No. 1.

*No. 3 Aerial.*—Single wire indoor aerial, about 30ft. long and 15ft. high. This was 25ft. away from, and roughly parallel to, aerial No. 1, and ran in an opposite direction to aerial No. 2. The mean distance between aerials Nos. 2 and 3 was therefore about 40ft.

*No. 4 Aerial.*—Single wire, 35ft. long, 12ft. high, and 40ft. away from, and roughly parallel to, aerial No. 1.

In all these experiments to be described the earth connections were made to the same water supply system unless otherwise stated, although much the same results were obtained when using dissimilar earthing points, such as, water pipe—gas pipe, water pipe—buried plate, or water pipe—counterpoise.

### The Effect of a Low Tuned Aerial Upon Reception from a High Aerial.

The first experiment was made by receiving the local broadcast (2LO, ten miles distant), using a crystal set on the large aerial No. 1, and by employing the small

**Interference from Adjacent Aerials.—**

outdoor aerial No. 2 as the interfering aerial. A "perikon" crystal combination set to a firm and stable contact pressure was employed for reception, and a moving coil microammeter included in the detector circuit to indicate the amplitude of the rectified current obtained. The rectified telephone current normally obtained (with the small energy absorbing aerial No. 2, either earthed or open-circuited) was  $16.2 \mu A$ , but this value was reduced to  $1.2 \mu A$  when aerial No. 2 was tuned efficiently to resonance with the transmission being received. This great reduction of signal strength only occurred, of course, when the energy absorbing aerial was very efficiently tuned, the absorption effect being much less marked when a load "R" was taken from its oscillatory circuit "LC" (Fig. 1). The effect on the absorption of various loads on the absorbing aerial is shown in Fig. 1, which gives curves of rectified current from the receiving aerial No. 1 plotted against degree scale readings of a  $0.0003$  mfd. variable condenser (uniform capacity change type) tuning the absorbing aerial.

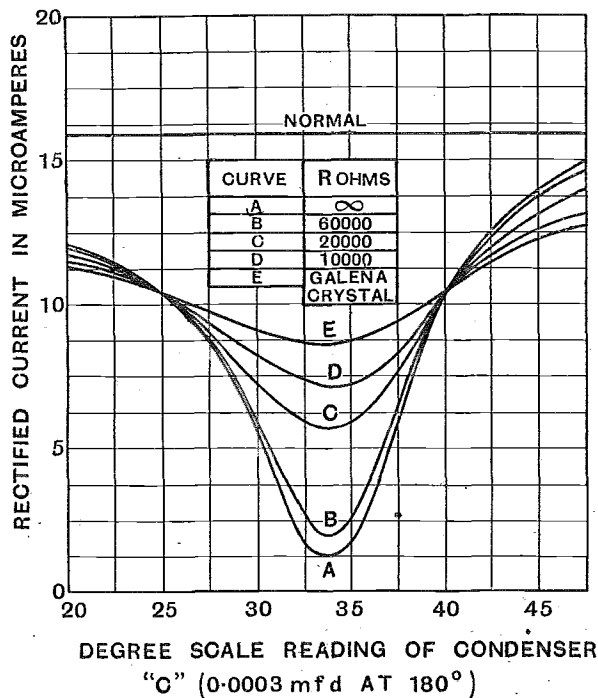
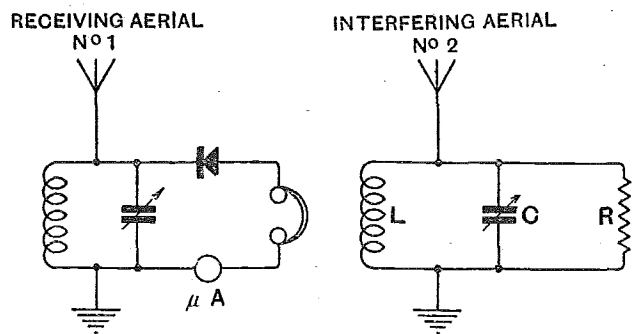

Fig. 1.—Curves showing the diminution of signal strength due to the tuning of a small near-by aerial.

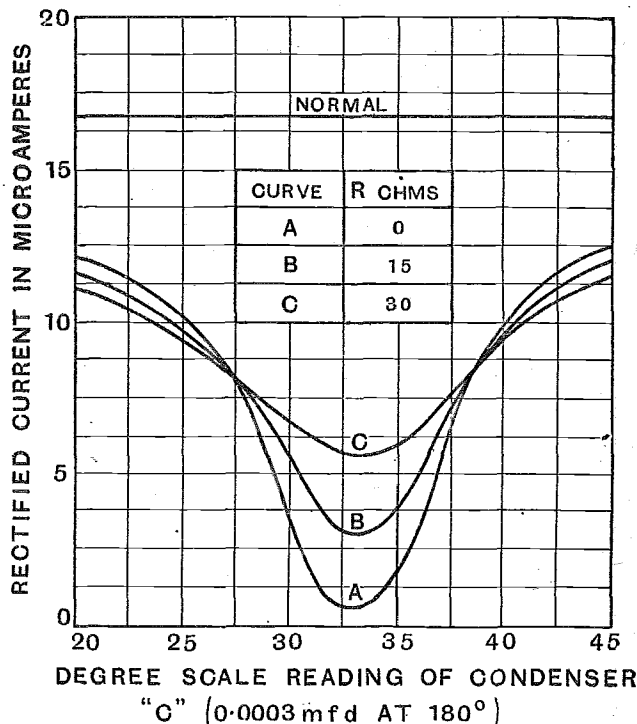
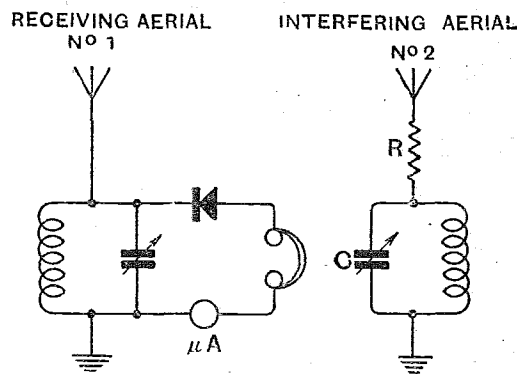

Fig. 2.—Showing the effect of the effective resistance of the interfering aerial upon signal strength diminution.

It will be observed that the loads of lowest impedance flatten the absorption curves as well as reduce the total diminution of signal strength at resonance. It will be observed, also, as an interesting point of practical importance, that the raising of the catwhisker of the absorbing aerial set from a low-resistance setting, corresponding to the flattest curve, will cause the rectified signal current to fall suddenly from  $8.5 \mu A$  to  $1.2 \mu A$ .

The curves of Fig. 2 show how the absorption effect of the No. 2 aerial is reduced by increasing its effective resistance by the insertion of non-reactive resistances in series with it, and thus, as in the previous case of parallel loads, limiting the aerial current and consequent aerial power absorbed.

It should be noted that for the curves of Figs. 1 and 2, at resonance a change of 5 degrees in the reading of C corresponds to a wavelength change of the order of 6 metres, the resonance wavelength being about 365 metres.

**Interference from Adjacent Aerials.—**

One would expect the smaller aerial to absorb less energy if a higher resistance gas pipe earth connection was used, and this was actually found to be the case, as is shown by curve "A" (Fig. 3), of energy absorption when no load was taken from the oscillatory circuit of the absorbing aerial.

A valve detector without reaction was then connected to the oscillatory circuit of the absorbing aerial, and this road flattened the energy absorption curve, as shown by curve "B" (Fig. 3). When reaction was employed in this detector valve circuit, however, the absorption of energy from the large receiving aerial was much more complete, due to the negated losses of the absorbing aerial circuit through reaction. The curve of rectified current from aerial No. 1 under these conditions is that of "C," Fig. 3, and the effect of swinging the tuning condenser of the absorbing aerial through an angle of, say, 15 degrees at resonance can well be imagined.

By still further increasing reaction on the receiver of the interfering aerial almost up to the point of self-maintained oscillation, another curve "D" of rectified current from No. 1 aerial is obtained. The extremities of this curve indicate the points at which self-oscillation of the detector valve commences on either side of resonance, it being, of course, impossible to continue the curve beyond these limits. It will be observed, however, that before self-oscillation commences, on the higher wavelength side of resonance, an increase in signal strength above the normal value is obtained from the No. 1 aerial, due to a re-radiation from No. 2 aerial, when the tuning of the latter was sufficiently far from the absorbing point. At the same time, the absorption curve is made very steep, a change of tuning of the valve set of the interfering aerial of only about 10 metres (38 degrees to 32 degrees) reducing the rectified current from 16  $\mu$ A to zero.

From these results it will be seen that it is possible for a small low aerial to affect very seriously the signal strength obtained from a crystal receiver of an adjacent high aerial, although the case depicted in the curves of Fig. 3 is, of course, an extreme one of very close aerials. It should be noted that the signal strength cannot be regained by any re-tuning of the crystal set. It is of interest to note, also, that, if the valve set of the interfering aerial is adjusted to a condition of extreme reaction whilst the crystal set aerial is tuned to resonance, it may be made to burst into self-oscillation by detuning the *crystal set aerial*.

An energy absorbing aerial having its losses negated by reaction so as to give a very steep energy absorption curve similar to that of "D," Fig. 3, can, of course, be made to function as a kind of "wave trap." It was while this experiment was being performed that the German broadcasting stations were first heard, at excellent strength, by the writer on a plain single circuit "perikon" crystal receiver, during the transmission of 2LO and without the slightest possibility of re-radiation, as the same stations were afterwards heard at the same strength during intervals in 2LO's transmission with all other aerials in the vicinity rendered inoperative.

**The Effect of a Large High Aerial Upon Reception with a Small Low Aerial.**

The second experiment was carried out by receiving

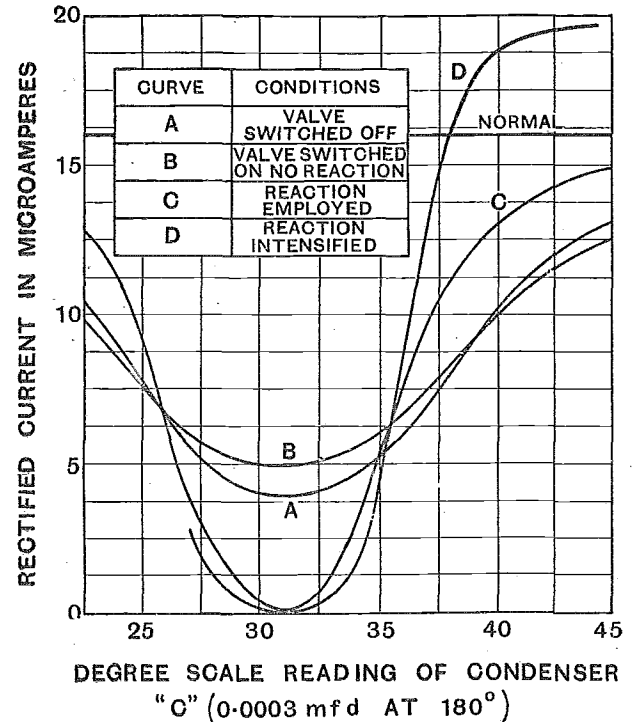
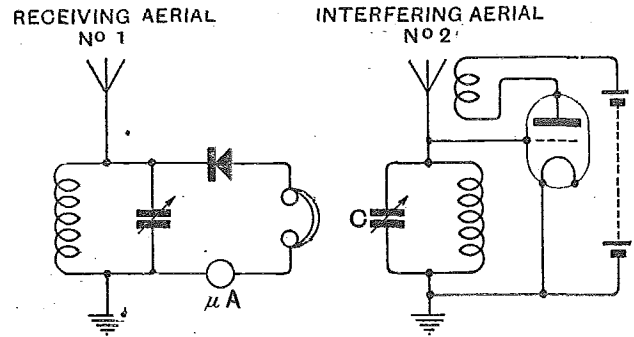

Fig. 3.—Showing the effect of reacting into the interfering aerial.

(by means of a "perikon" combination crystal set) on the small outdoor aerial No. 2 with the large high aerial No. 1 interfering. In this case, after a stable crystal had been found, the normal rectified signal current obtained with the No. 1 aerial open-circuited was 0.5  $\mu$ A, speech being just comfortably intelligible under these conditions with highly sensitive telephone receivers.

Leaving the receiving aerial tuned to resonance with the transmission being received, the interfering aerial was also efficiently tuned to the incoming signal, no load being taken from it. The result was the large increase of signal strength indicated by curve "B" of Fig. 4, the curve being, like those of the previous figures, rectified signal current from the *constantly tuned receiving aerial* plotted against degree scale readings of the variable condenser tuning the *interfering aerial*.

For this augmentation of signal strength by re-radiation from the interfering aerial to be very great, the latter must, naturally, have an extremely low effective resistance. For instance, as soon as its tuning circuit is

**Interference from Adjacent Aerials.—**

shunted by a load impedance of 20,000 ohms (roughly equivalent to the practical case of a perikon crystal load), its re-radiated energy is limited, as shown by the flattened signal strength augmentation curve A (Fig. 4). The latter effect would also, of course, be obtained if the earth connection of the interfering aerial was of high resistance or the aerial system inefficient in any other way. **The Re-radiation of Energy from a Large and Efficient Aerial.**

On the other hand, if the losses of the interfering aerial system are negated by reacting into the aerial oscillatory circuit from the anode circuit of a detecting valve, the increase of signal strength may be made very great indeed. The curves C, D, and E, of Fig. 4 show

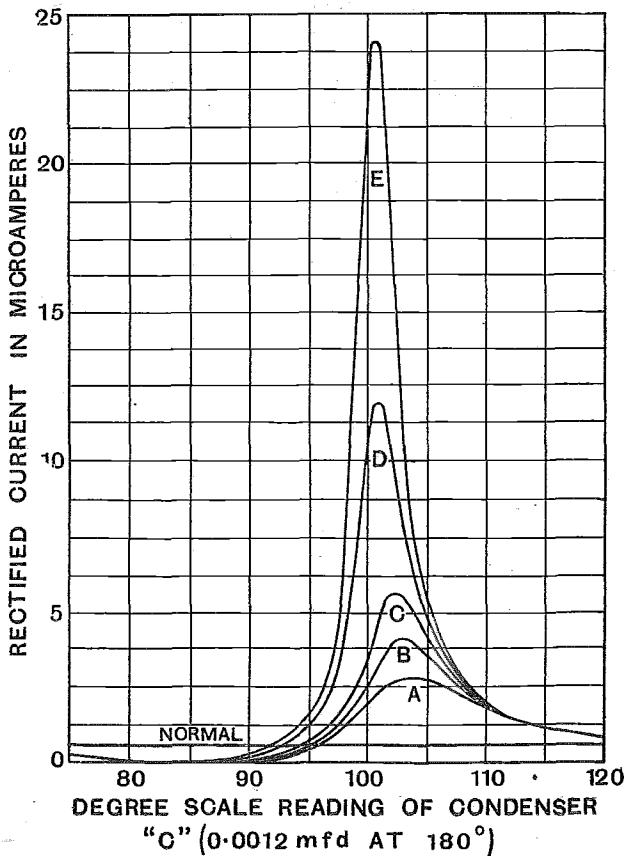
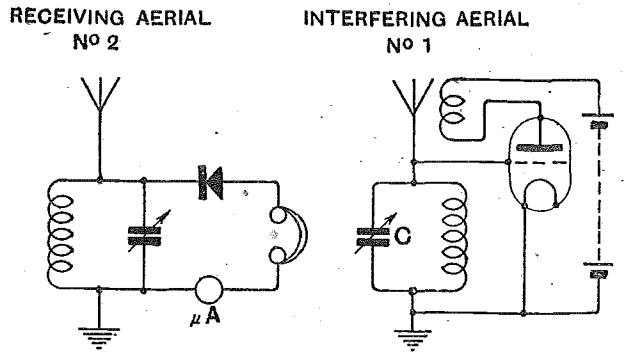

Fig. 4.—Signal strength augmentation curves due to re-radiation from a large neighbouring aerial.

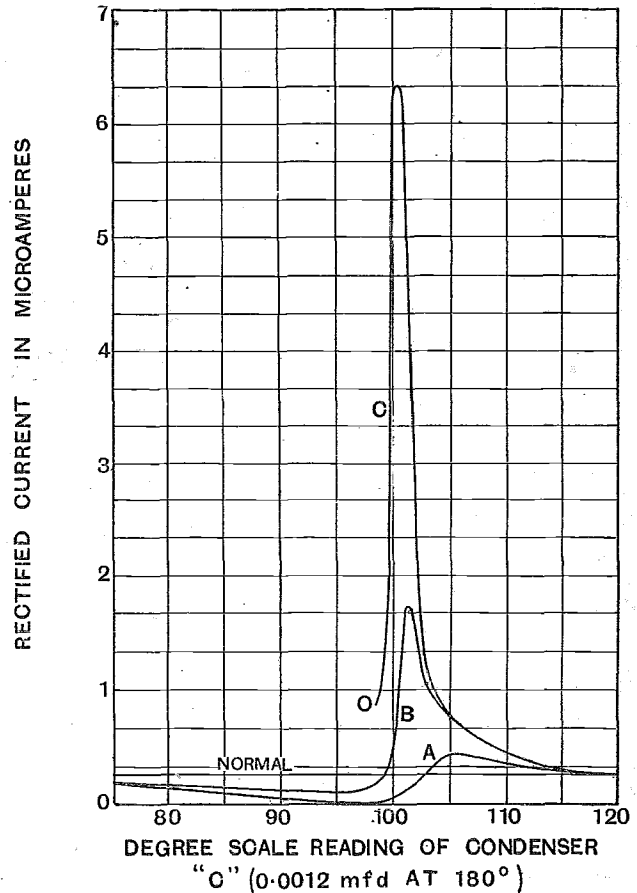
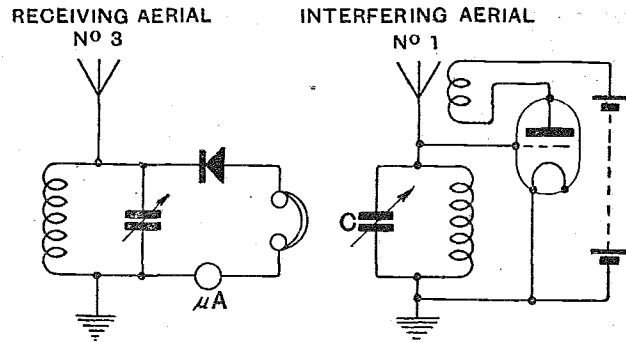

Fig. 5.—Showing the augmentation of signal strength from an indoor aerial by re-radiation from a near-by aerial.

the augmentation of signal strength actually obtained by various increasing degrees of reaction, curve E being taken with a degree of reaction which still left the receiver far from the state of self-maintained oscillation.

From these curves it will be seen that a crystal set owner can obtain an extremely good strength of reception with a very indifferent and low aerial, provided that a near-by high and efficient aerial is being constantly re-acted into, as the tuning adjustment for maximum signal strength of the reacting valve receiver corresponds with the peaks of the crystal set signal strength curves of Fig. 4.

The sharpness of curve E may be judged from the fact that, at resonance, 5 degrees of the condenser scale

**Interference from Adjacent Aerials.—**

correspond to about 6 metres (i.e., the rectified current being received is halved by detuning the interfering aerial by 2 metres only). This amount of detuning could not, however, be made on the re-radiating aerial without an attendant loss of signal strength in its own receiver.

Fig. 5 gives similar curves of rectified current obtained from a crystal receiver on the small indoor aerial, No. 3 using a perikon crystal, and with the large No. 1 aerial re-radiating. Under these conditions the normal rectified telephone current obtained was only 0.25  $\mu$ A with the large aerial open-circuited, and curve A shows the in-

crease due to tuning alone, while B and C are the signal strength augmentation curves for two reaction adjustments of a reacting valve detector. The valve set of the re-radiating aerial was reacting very strongly, whilst curve C was being plotted, so strongly in fact that it burst into self-oscillation at the extremity "o" of the curve on the lower wavelength side of resonance. Due to the greater degree of reaction employed, the curve C of Fig. 5 is even sharper than that of E of Fig. 4, detuning by less than 1 metre halving the rectified current from the receiver associated with the other aerial.

(To be concluded.)

**Glasgow.**

April 26th, from 15.50 till 00.48 April 27th.

*American*:—1AAC, 1ASF, 1BOQ, 1CCX, 1CKP, 1CMP, 1CMX, 1ER, 1OW, 1TE, 1SF, 1XAM, 2AXF, 2BGI, 2DK, 2MU, 3ACE, 4UK, 4XE, 8AVL, 8GZ, 9CCX, 9EFZ, 9LC, 9XAX.

(0-v-1 Reinartz.) (All around 20 metres.) J. GORDON RITCHIE.

**Basrah, Iraq.**

*British*:—2NN, 2UU, 2OM, 2CC, 5NN, 2FU, 6NM.

(All between 50 and 150 metres.) J. E. LONG.

**Berne, Switzerland.**

*British*:—2CC, 2LZ, 2MA, 2SH, 5HA, 5LF, 5YI, 6GH, 6NF. JOHN GYSIN.

**Wadstena, Sweden.**

*British*:—2BY, 2KZ, 2SN, 2TF, 2WD, 2WJ, 5BV, 5CC, 5LB, 5MA, 5MO, 5NN, 5PU, 5QV, 5XN, 6BR, 6FG, 6GH, 6KK, 6ME, 6SR, 6UV.

(0-v-1 Reinartz.) R. HULT.

**Bridgeport, Conn., U.S.A.**

*British*:—2CC, 2JF, 2KZ (telephony and C.W.), 2NB, 2WJ, 5BV, 5LF, 5NN, 5PU, 5SZ, 6NF, 6UV.

C. H. CAMPBELL (U1IV).

**Gloucester City, N.J., U.S.A.**

*French*:—2KF (in daylight), 2KZ. *French*:—8AB.

W. R. EBENSPERGER (U3JW).

(Transmits on 38.5 metres.)

**Newton, Iowa, U.S.A.**

*British*:—5LF, 6NF, 2KL or 2KZ. *French*:—8AC, 8BV, 8GO. *Italian*:—ACD.

C. H. MORGAN (U9EFH).

**Waihemo, New Zealand.**

*British*:—2WJ, 2SH, 2JF, 5LF, 5NN, 6TM, 2LZ (?). *French*:—8AB, 8BF, 8OG, 8GK, 8QM, 8SM, 8CZ. *Italian*:—ACD.

F. D. BELL.

**Ashford, Middlesex.**

April 25th-26th.

*American*:—1CMX, 1CKP, 1XAM, 4DU, 4TV, 4XE, 9XAX, 9ZT.

(0-v-1.) (All on 20 metres.)

A. G. ROGERS.

**Harrow, Middlesex.**

*Australian*:—2DS, 2YI, 3BD, 3BQ, 5BG, *New Zealand*:—4AA, 4AG, 4AK, 4AR. *Porto Rican*:—4JE, 4OI, 4SA. *Chinese*:—HVA. *Mexican*:—1B, 1K, 1N, 1AA, 1AF. *Javan*:—ANE.

(0-v-1.) All QSL's answered.

T. A. and F. C. STUDLEY.

## Calls Heard.

### Extracts from Readers' Logs.

**Longsight, Manchester.**

*British*:—2DD, 2DX, 2INB., 2NB, 2NJ, 2SW, 2TU, 5CD, 5JN, 5LB, 5LF, 5MA, 5NN, 5OC, 5OK, 5PZ, 5TZ, 5UQ, 5YI, 6CH, 6KK, 6MP, 6MX, 6TD.

(0-v-1.) (All between 40 and 100 metres.) PERCY COX.

**Sutton, Surrey.**

(April 5th-19th.)

*British*:—2BL, 2CC, 2IN, 2XY, 5DA, 5OK, 5WG, 6GK, 6IA, 6JO, 6RY, 6TD. (QSL cards waiting.) E. J. SMITH.

**Balham, S.W.**

*British*:—2XV, 2AGP, 5OK, 5MA, 5NX, 2RA, 5SZ. *Dutch*:—OBA, OBQ, OGG, OHB, OPV, 2PZ. *Belgian*:—4LOV, 4W, 3ZZ. *Italian*:—1AZ. *Danish*:—7EC. *Swiss*:—9LA. *Sweden*:—SMSC.

(0-v-1.)

W. STUART CLARK.

**Acock's Green, Birmingham.**

*American*:—1AF, 1AJC, 1AJX, 1AXA, 1AQI, 1BDX, 1BVL, 1CKK, 1CMX, 1CPC, 1CRI, 1MY, 1PL, 1SK, 1WL, 1YK, 2AQR, 2AFC, 2AGQ, 2ACS, 2CJB, 2CPC, 2CVJ, 2CTF, 2GK, 2LD, 2MU, 2WB, 3AW, 3CJN, 3BMS, 3HB, 3QV, 3HJ, 3UE, 3ZM, 4BJ, 4BY, 4ER, 4JY, 8BFE, 8DQR, NERK1, NKF. *Canadian*:—C1EB.

(0-v-1.) (60-90 metres.)

FRANK J. TAYLOR.

**Woking, Surrey.**

(PSE, QSL, all cards answered.)

*French*:—8AE, 8BC, 8CO, 8CZ, 8DD, 8DW, 8EU, 8EX, 8FF, 8GGA, 8GI, 8GM, 8GN, 8GX, 8GT, 8HSF, 8IB, 8IP, 8ISH, 8JA, 8JR, 8KX, 8LA, 8LL, 8ML, 8NA, 8NG, 8NH, 8NS, 8OA, 8OW, 8PLM, 8QS, 8RD, 8RF, 8RIC, 8SG, 8SJ, 8SSC, 8SSU, 8SST, 8TK, 8UA, 8UT, 8XH, *Miscellaneous*:—U2AJ, G2BT, G2DX, G2NB, 5OK, 5MA, 6TD, KH, 2HG (tel. 50 metres), 2NA, 2ND.

(0-v-1.) (All between 45-125 metres.)

W. E. RUSSELL

(2AZA).

**Beaulieu, Hants.**

*Dutch*:—OCDJ, OBQ, OGC, OMS, OGG, ONL, OMR, ORW, OPV, OMR, OSO, OXF, 1PC, 2PZ, 3PB, 9HN. *Swiss*:—9LA. *Finnish*:—2NN. *Russian*:—RDW (Nijni Novogorod). *Italian*:—IAM, IAS, IGN, ICF, IMT, IWB. (0-v-0.) J. L. MACKENZIE.

**Cricklewood, London.**

*British*:—2JF, 2NB, 2NJ, 2ZB, 5BH, 5HA, 6AL, 6GH, 6GM, 6QB, 6RM, 6TD. (0-v-0.) J. C. EVERETT.

**Crouch End, London.**

*British*:—2AUW, 2CC, 2DR, 2FM, 2JJ, 2LZ, 2NB, 2NW, 2VO, 2VQ, 2XU, 2UX, 5BA, 5BH, 5DA, 5FS, 5IG, 5JK, 5LB, 5OC, 5PZ, 5TZ, 5UV, 5ZA, 5ZU, 6AL, 6BR, 6DV, 6FG, 6GH, 6JO, 6JT, 6KJ, 6MP, 6RM, 6TD, 6UB.

C. BRADLEY.

**Pinner, Middlesex.**

*British*:—2JB, 2XF, 2LZ, 2KG, 2FV, 2BA, 2APA, 2ANX, 2FN, 2II, 2TA, 2KZ, 2JF, 2DR, 2KU, 2XO, 2ZO, 5KM, 5YR, 5SI, 5LS, 5XL, 5SZ, 5LP, 5EL, 5CT, 5TV, 5UO, 5ZA, 5RB, 5IR, 5AI, 5PU, 5IG, 6QZ, 6TD, 6XG, 6OK, 6CC, 6MP, 6SW, 6JO, 6FG, 6QB, 6KJ, 6GH, 6NH, 6HR, 6YG, 6IV, 6CH, 6NF. (0-v-0 low-loss.) NORMAN GUY.

**Addiscombe, Surrey.**

*French*:—8AG, 8AY, 8BF, 8CJJ, 8CN, 8CO, 8CPP, 8CT, 8DDL, 8DL, 8EO, 8GH, 8GI, 8GK, 8GM, 8GN, 8HGV, 8HRA, 8HSD, 8HSR, 8II, 8JA, 8JBL, 8KX, 8MAR, 8MJM, 8MN, 8NK, 8NO, 8NS, 8PD, 8PL, 8PLM, 8PP, 8RBR, 8RLH, 8RCN, 8RIK, 8SG, 8SSU, 8TH, 8TK, 8UD, 8UDI, 8UT, 8VAA, 8VT, 8VAL, 8WNM, 8XMY, 8YD, 8YOR, 8ZC. H. L. O'HEFFERMAN.

(0-v-1 Reinartz.)

**New Moston, Manchester.**

2ART, 2DX, 2FU, 2KW, 2KZ, 2LZ, 2PP, 2TF, 2WJ, 5ID, 5IG, 5OK, 5PU, 5SI, 6CH, 6TD. J. BARNES.

(0-v-1.)

**Leyton, London, E.10.**

April 26th and 27th.

*American*:—1ASF, 1CCX, 1CKP, 2BGI, 8AVL, 9XAX. S. W. BAKER.

(All on 20 metres.)

**South Shields.**

*British*:—2JX, 2KZ, 2NJ, 2VO, 2XV, 2YX, 5JX, 5MA, 5HS, 6MP, 6RM, 6TD, 6UD, 6UV. JOHN G. CARLSON.

(0-v-0 Reinartz.)



# Broadcast Brevities



## SAVOY HILL

### Removal of 5XX.

While 90 per cent. of the population is now within crystal range of one, at any rate, of the main stations, Savoy Hill will not rest content until every man, woman and child throughout the Kingdom has the means of receiving broadcast whenever desired. Needless alarm has been expressed over the contemplated removal of 5XX to Daventry in August next, and the last thing likely to happen is that any existing body of listeners will be allowed to become isolated unless they become converted from the crystal to the valve.

○○○○

### More Crystal Users.

I understand, however, that the B.B.C., while not wishing either to insist upon crystal reception by listeners or upon the general adoption of the valve, has plans for bringing in new crystal populations reaching a potential total of 3½ million persons. This development is contingent on the raising of certain existing stations, including London, to a power of 10 kilowatts, and the erection of additional stations in the south, west, east and north; but this is for the future and does not merit consideration until as a first step the certainty that all listeners are willing to pay for the service that they receive, and have become bona-fide licencees, is fully established.

○○○○

### Morse at Southend.

Since the problem of interference was raised to the level of a question of supreme moment to the listener, the blame for much of the jamming that is taking place has been fastened on to any and every sort of wireless station without discrimination. A seaside journal has recently shown great thoughtlessness in putting the blame on the North Foreland Station for interference in the Southend area. In view of the steps which the Post Office took some time ago to prevent any jamming by Morse of the broadcast service in that district, the attack is grossly unfair, and it cannot be stated too plainly that whatever interference is being caused in Southend is not due to the North Foreland.

○○○○

### Radio Advertisements.

Approaches are made from time to time by business firms and individuals for the privilege of broadcasting advertisement matter, and high prices are offered for short announcements, subtly disguised as items of news and informa-

## TOPICALITIES

tion. While the B.B.C. may not receive a consideration for broadcasting commercial information or certain other kinds of messages without the consent of the Postmaster-General, it may be stated that the Company has no intention of seeking Post Office sanction for such a concession.

○○○○

### Experience of America.

It has been pointed out that the large revenue which might be secured by broadcast advertising would enable the B.B.C. to give better programmes and so benefit the listener. But it would not fit in with the ideals of the Company to commercialise the service in the manner suggested; and it is probable that in the end the listener would stand to lose rather than gain. In America the broadcasting of advertisements long since became a regular nightmare to listeners, who, in the end, got to know the publicity stations and carefully avoided tuning in to any of them. So far from big prices being obtained for advertisements by wireless, the experience of America has shown that as soon as the novelty has worn off advertising agents have secured their advertisements at rates lower than those charged by journals with a circulation of a modest five thousand.

○○○○

### Taking Precautions.

At considerable cost the old 2LO station at Marconi House has been reinstated and made ready for service at any time required. This step, which was favoured from the time that the Oxford Street station first came into operation, but was not at once adopted, has been decided on as a result of the recent breakdown of the new station, when, for ninety minutes, the programme suffered interruption.

○○○○

### Ready for Emergencies.

It was then pointed out that the transmission from 5XX was available to all listeners who cared to tune in on the higher wavelength; but apparently many listeners did not go to that trouble, preferring rather to wait on in the expectation that matters would soon be put right at Oxford Street. In future, therefore, the Marconi House aerial will be ready for any emergency, though the possibility of a recurrence of the former trouble is very remote.

○○○○

### German Broadcasting.

The move to raise the power of all German broadcasting stations to ten kilowatts is interesting to listeners in this country at a time when suggestions are

## FUTURE FEATURES.

### Sunday, June 7th.

LONDON.—4 p.m., Organ Recital.  
MANCHESTER.—4 p.m., Band of the Salford City Police.  
ABERDEEN.—4 p.m., Chamber Music.

### Monday, June 8th.

5XX.—8 p.m., Band of the Royal Air Force.  
LONDON.—8 p.m., "The Song of Hiawatha" (Coleridge Taylor). S.B. to all stations except 5XX and Cardiff.  
CARDIFF.—8 p.m., An Hour with Schumann.

### Tuesday, June 9th.

LONDON.—8 p.m., "What is This?" A Memory Test Programme. S.B. to Cardiff.  
BIRMINGHAM.—8 p.m., Musical Comedy Programme.  
BELFAST.—8.15 p.m., The Play "Trilby" (George du Maurier).

### Wednesday, June 10th.

BOURNEMOUTH.—8 p.m., A Programme of Humour.  
MANCHESTER.—8 p.m., Chamber Music.

### Thursday, June 11th.

LONDON.—8 p.m., An Hour with Edward German.  
ABERDEEN.—8 p.m., Scandinavian Night.  
LIVERPOOL.—8 p.m., Birthday Programme.

### Friday, June 12th.

LONDON.—10.30 p.m., "My Adventure in Jermyn Street," by A. J. Alan  
BOURNEMOUTH.—8 p.m., Military Band and Musical Comedy.  
GLASGOW.—8 p.m., "The Rob Roy Country."

### Saturday, June 13th.

LONDON.—8 p.m., A Dance Evening.  
BELFAST.—7.30 p.m., "The Dance thro' the Ages."

being made that the main B.B.C. stations, or at any rate several of them, should be granted a similar facility.

o o o o

#### That Sunday Nap.

Considerable agitation has been caused by the alteration of the Sunday afternoon broadcasting hours. When the programme began at 3 o'clock many listeners complained that if they listened they missed their customary Sunday afternoon nap. Some 450 people wrote to the B.B.C. to that effect. Since the hour of commencement was put back to 4 o'clock a few weeks ago, 500 listeners have written complaining that the alteration interferes with their tea-time arrangements, as they are not able to get that ceremony over in comfortable time to enable them to attend the evening church services. It seems that a better arrangement would be to re-time the afternoon transmissions between 3.30 and 5.30 p.m., and the point is under consideration.

o o o o

#### World Broadcast.

The possibility of the international broadcast of such important transmissions as have been taking place recently, to wit, the King's speech at the opening of Wembley, the Prime Minister's Empire Day message, and brilliant talks by some of the most learned men in Great Britain, depends to a large extent on the elimination of distortion, which occurs in wireless, though to a lesser degree than in submarine cables.

o o o o

#### Power of the Repeater Station.

There is no fundamental reason why distortion should not be eliminated by higher powers and beam transmissions. The overhead telephone line must, however, be used wherever possible, for

connecting up national systems. The use of thermionic valves will ultimately prevent the attenuation of signals over any length of line.

o o o o

#### Wire and Wireless Wedded.

Within, perhaps, a year or two some spot, say in Cornwall, will be the centre whence the New World will link up with the Old by beam transmission and reception. The signals passing into the aerials here will be broadcast immediately to all parts of the British Isles. They will simultaneously be transmitted by physical wire *via* London to Paris, Berlin, Vienna, Prague and all Europe from similar national centres. Wireless links may be established in areas where the ground is impassable for the overhead line. Africa may be linked up across the Sahara Desert. It is not improbable that wire and wireless suitably linked together may, by way of Constantinople, bring India within the broadcast union, and thence by high-power wireless beams, Australia and New Zealand will come within the range of world broadcasting. By the utilisation of the wire, where conditions permit, and of the wireless beam over jungle, mountain and sea, there is no reason why, within reasonable distance of time, the voice of King George should not be heard by 100,000,000 of his subjects, even in the remote corners of the Empire. That is the vision of the future which the B.B.C. is keeping ever in mind.

o o o o

#### B.B.C. Listening Station.

The new B.B.C. listening station which, as stated recently in these notes, is to be established near Bromley, Kent, will, I am told, be brought into service this month. It has been erected in an isolated locality so as to be free from

interference with or by other stations, and is connected by land line to London. The station will do a good deal of work in the way of interception. It will be possible to pick up KDKA and to transmit any part of the Pittsburg station's programme through 5XX. It will also link up with the Continent for wireless relay work. Most important of all, perhaps, is the fact that this super-receiver will be able to locate any jamming or other interference with the B.B.C. service, and to ascertain whether any B.B.C. stations are off their wavelengths and give them proper calibration.

o o o o

#### "Bottled" Wireless.

I am told that the electro-magnetic recording machine by which the so-called "bottled" broadcast will be rendered possible, is operated on the principle developed by Poulsen some twenty-five years ago, namely, the running of a wire through a varying magnetic field so that the magnetisation on the wire varies according to the strength of the magnetic field which is itself proportional to the speech current set up by a carbon microphone connected in the magnetising circuit. For reproduction the operation is reversed and the magnetised wire is run past a soft iron core producing currents in the winding of the core which are similar to those originally produced in the microphone circuit. The machine, which is more or less in the embryonic stage, is a German invention, and can be used for recording broadcast—either speech or music—thus storing it for later reproduction, either by wire or wireless.

o o o o

#### What the Machine Can Do.

When the B.B.C. engineers recently examined the machine it proved satisfactory as far as speech was concerned. The recording of music was not particularly good, but it was understood that the experiments had only just been started, and important developments were only a matter of time. Chief among the imperfections was the difficulty of obtaining a constant speed motor to give equal strength, and of securing a steel wire which was sufficiently hard to retain the magnetisation given to it, and a constant cross-section so that equal magnetisation forces on any section of the wire have equal effects.

o o o o

#### An Asset.

A recording machine would be a real asset to British broadcasting, as it would enable a permanent record to be obtained simultaneously with an artist's broadcast performance, or would enable an artist to store a performance from his or her own home by telephone to a broadcast studio for transmission at any future time. The difference between this method and the ordinary gramophone record is that an important stage would be eliminated and the record would be a direct reproduction of the actual song or speech, while a gramophone record is a reproduction of a reproduction.

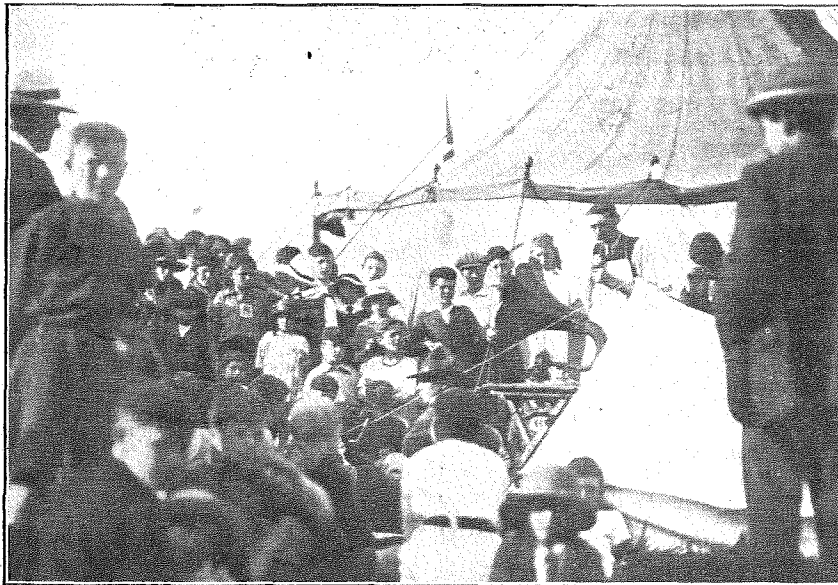

A MESSAGE FROM THE B.B.C. On the occasion of the athletic sports of the 2nd Goodmayes Boy Scouts, the B.B.C. caused delight by transmitting a message of greeting. The photograph shows an attentive group listening to the message on the loud-speaker.

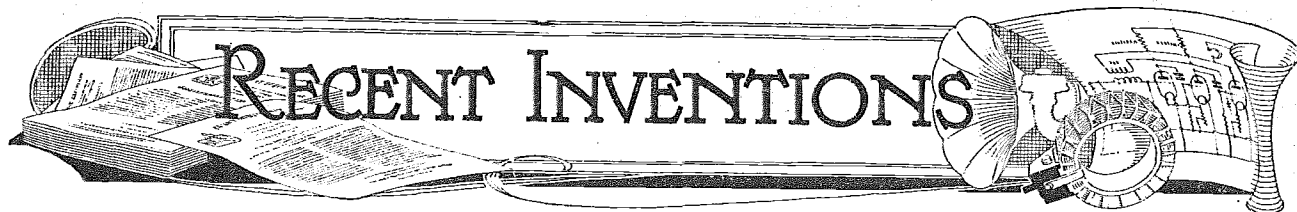

Brain Waves of the Wireless Engineer.

**An Improved Short-Wave Patent.**  
(No. 227,138.)

C. S. Franklin, whose name is widely associated with short-wave transmission, describes in this specification an interesting method of paralleling valves. If a number of valves are connected in parallel by the ordinary type of bus-bar, appreciable capacity is added to the circuit. This may be of very serious consequence when the wavelength is comparatively short—that is, below 100 metres. Not only is this capacity undesirable from the point of view of affecting the tuning, but it is extremely liable to give rise to local tuned circuits, and it then becomes almost impossible for the valves to generate properly and deliver their entire output to the aerial system. These difficulties are overcome in the following manner. The accompanying illustration shows three valves— $V_1$ ,  $V_2$ , and  $V_3$ —provided with the usual anode and grid coils— $L$  and  $G$ —and variable tuning condensers— $C$ . The filaments are connected in parallel and supplied from the common source, while the anodes are supplied from a common source of H.T. through resistances  $R_1$ , which tend to equalise the current supplied to the valves. Blocking condensers  $B$ , of course, are connected between the lower ends of the grid and anode coils. The potential of the grids is controlled by connecting the grid side of the blocking condensers by resistances  $P$  to the filament. So far there is nothing abnormal about the valve oscillators. It will be seen that the grids and anodes of the valves are not directly connected in the normal way. The anodes are connected by a common anode bar

through resistances  $N$  and condensers  $M$ , while the grids are connected through a common grid bar through resistances  $X$  and condensers  $Y$ . The function of the condensers is to prevent any direct current passing between the valves, while the function of the coupling bars is to prevent oscillation occurring in the circuits formed by any two valves and the coupling bars. Each anode coil is coupled to a separate aerial coil  $A$ , which may be connected in parallel in the aerial circuit. When working on very short wavelengths there is still a liability of longitudinal oscillation occurring, and it is then found convenient to insert resistances in series with the bars between the various points of connection. We should imagine that the amateur experimenter who works on short waves would find this invention of considerable value.

o o o o

**A Peculiar Frame Aerial Receiver.**  
(No. 223,648.)

Readers who have experimented with frame aerial receivers will, no doubt, remember that their first attempts were probably not very successful, owing to the fact that they found it somewhat difficult to obtain full amplification owing to the set oscillating too readily. A. W. Sharman describes in this patent a set which, it is claimed, is exceedingly sensitive and very stable, and eliminates the possibility of radiation. It will be seen from the accompanying illustration that the circuit employed is practically an ordinary form of transformer-coupled two-valve reflex receiver. The peculiarity of the invention lies in the connections of

the grid circuit of the first valve. This includes the frame  $F$  tuned by a variable condenser  $K$ . Normally this frame circuit would be connected between the grid and, in the case of a reflex circuit, one side of the secondary of an audio-frequency transformer. However, it will be seen that a condenser  $C$  of small capacity is inserted between the frame and the

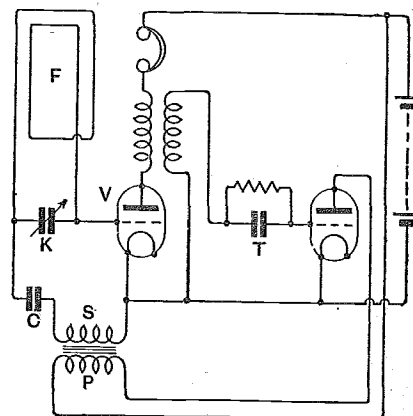

A novel frame aerial reflex receiver.  
(No. 223,648.)

secondary of the transformer. This results in the accumulation of a negative charge on the grid of the valve  $V$ . It is stated that the negative potential is sufficient to prevent the set oscillating, and also that the valve is in its most sensitive and responsive condition. It is not exactly clear why this is the case, and it seems to us that if the sole function of the condenser is to maintain a negative grid potential, it would be more practicable to provide this by means of a bias battery or potentiometer in the usual way. This method, of course, would eliminate the disadvantage of a free grid, but the system is interesting, and should appeal to the reader who is fond of experimenting.

o o o o

**A Buried Aerial.**  
(No. 224,661.)

The above patent granted to H. P. T. Lefroy describes a form of aerial which might prove of interest to those who are unable to erect an aerial, although, of course, the primary object of the invention was not connected with this fact. Aerials laid along the surface of the ground have been used for a considerable time, but they have been subject to rather excessive dielectric and hysteresis

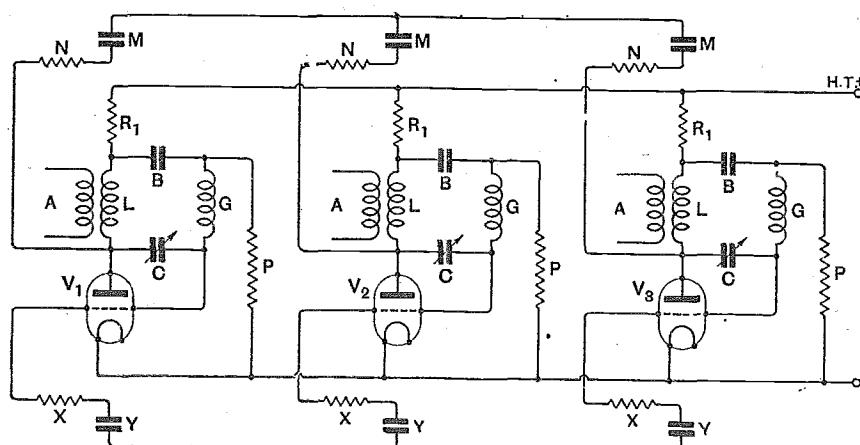

Paralleling valves for short wavelength transmission. (No. 227,138.)

losses. It has been found that if a trench or tunnel is dug, and if an aerial is centrally disposed within the tunnel, its efficiency is materially increased. This is probably due to the fact that its capacity to earth simply has air as a dielectric, except, of course, at the points where it is supported on insulators. There is one disadvantage to its general use, however, as it has rather marked directional properties.

o o o o

**A Plug-in Coil.**  
(No. 227,288.)

A form of plug-in coil which has been patented by I. H. Parsons and A. E. J. Ball is shown in the accompanying illustration. The method of construction is exceedingly simple, and can be readily adapted to amateur requirements. If an ordinary multi-layer coil be wound the self-capacity is unduly high. This is caused partly by the proximity of consecutive turns, but chiefly by the capacity between successive layers. Various means have been devised for separating the layers, and have usually consisted in the insertion of small insulating strips. In this invention, however, a cord is placed over the first layer in a zigzag manner so that loops L project at each side. The remaining layers are wound and the cords are inserted in the same manner. The loops are then threaded with another cord R which acts as a lace, and this is pulled tight and tied off. It will be seen that the coil is practically held in a cord framework, and the result-

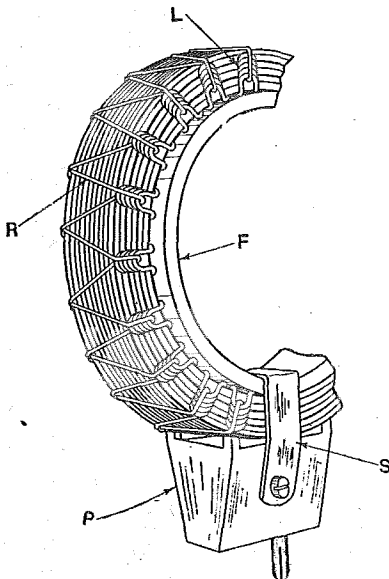

**A multilayer plug-in coil with a string spacer.** (No. 227,288.)

ing inductance is quite rigid. The winding is made, of course, on a cylindrical former F, which is fixed to an ordinary plug P by a strap S. Various systems of lacing and tying are described. A coil of this description would not be suitable for very short wavelengths, as the capa-

city would be too high, and the dielectric losses would probably be fairly heavy. This point has been dealt with in *The Wireless World* on several occasions.

o o o o

**Working Filaments from Electric Light Mains.** (No. 227,189.)

J. M. Turner and L. H. Soundy give in the above patent very extensive details of schemes for utilising the domestic electricity supply as a means of lighting valve filaments. The specification does not state the principles of operation of the inven-

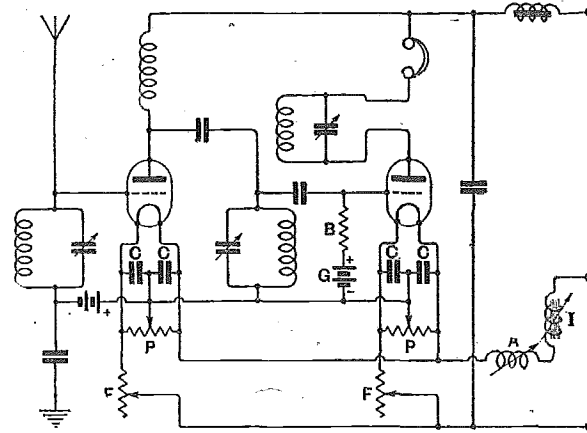

**Connections of a set for utilising the electric light main for filament heating.** (No. 227,189.)

tion, but the accompanying diagram serves to illustrate the most important points. A somewhat peculiar feature of the invention is that substantially the same arrangements are used both for direct and alternating current supplies, where the two conditions are rather different. The filaments of the valves are controlled by separate rheostats F, and potentiometers are placed across each filament. The sliders are used somewhere in the neighbourhood of the mid-points of the two halves of the potentiometer, and are shunted by condensers C. There is nothing, of course, novel in this feature alone. It will be noticed that the circuit shown is simply a high-frequency amplifier and valve detector, with a tuned grid circuit, reaction being obtained between the anode and the grid circuit of the detector valve. A claim of the invention is for the use of magnetic reaction in combination with a positive potential applied to the grid of the valve by a battery B through the grid leak G. A claim is also made for the foregoing feature in conjunction with a smoothing system, preceded and followed by fixed condensers, and consists of the usual system of chokes in the anode supply lead and in the filament circuit non-inductive resistance F for controlling filament temperature, and a composite variable air and iron core choke A, I. The specification does not mention the particular function of the composite filament lead choke. The specification should provide interesting subject matter for amateur experimental work. We would remind our readers, however, that when-

using alternating current for heating the filament the greatest proportion of hum which is produced is due to the rapid heating and cooling of the valve filament, which takes place at a frequency equal to twice that of the supply. Readers who experiment with alternating current for the filaments should use a valve of which the filament has a high thermal inertia, such, for example, as a Wecovalve. This filament is not particularly susceptible to rapid change of heating current, and thus it is quite possible to use a valve of this description with alternating current on the filament without the slightest trace of hum. In the case of direct current supply the commutator ripple is at a very much higher frequency than that of the frequency of the usual A.C. supply, and therefore this form of trouble is not nearly so pronounced.

o o o o

**A Sterling Valve Holder.**  
(No. 227,590.)

Several types of "anti-vibration" valve holders have recently been devised, and their use became popular with the introduction of some of the early types of dull-emitter valves, which were rather microphonic. That shown in the accompanying illustration is described in the above patent by D. Ward-Miller, W. M. Holbeach, and the Sterling Telephone and Electric Company, Ltd. The valve holder proper consists of an ebonite plate P, on which are mounted four sockets S. Below and by the side of each socket there is a bent clip C, which makes efficient contact with the valve leg. The plate P is supported on a flexible rubber ring R of "Sorbo" or similar material. Flexible

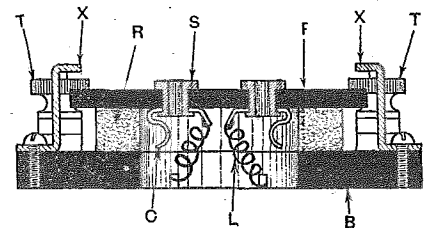

**The Sterling Electric Co.'s anti-vibration valve holder.** (No. 227,590.)

leads L are taken from the sockets S to the terminals T, which are mounted on the base B. An interesting feature of the invention is the provision of stops X of the shape indicated in the diagram. If these were not used the plate P would be liable to be torn from the rubber ring on removing the valve, but according to this construction the plate comes into contact with the bent portion of the stop, which then takes the strain.



A Review of the Latest Products of the Manufacturers.

**SHORT WAVE COIL.**

There is an even greater tendency to provide short wave tuning inductances with plug-in sockets than those used for

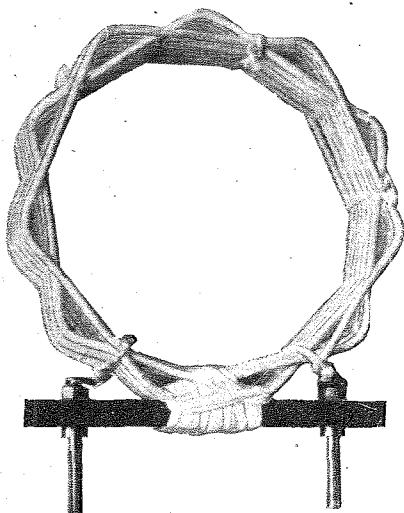

Webber short wave coil.

tuning to wavelengths above 300 metres. To cover the wave band 20 to 200 metres a considerable change is required in the inductance value of the tuning circuit, and on the short wavelengths it is not always desirable to make use of tapped coils. The standard type of plug and socket mounting is regarded by many experimenters as unsatisfactory on the short wave band, and the new design of plug-in mount recently introduced by Messrs. N. V. Webber & Co., of Vale Road, Otlands Park, Weybridge, is a step in the right direction. The pins are mounted on a strip of ebonite and liberally spaced, and the inductance is of a well-known design having low losses. To provide the necessary mechanical strength heavy gauge wire is employed, which is bound in at the crossovers with thread.

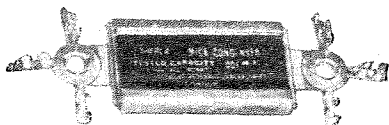

Therla condenser, fitted with tags for circuit connections, and enclosed in stout metal container.

**THERLA CONDENSER.**

Manufactured by the Electrical Research Laboratories, the Therla condenser is obtainable in a range of sizes from the smallest up to 0.01 mfd.

One of the greatest problems in fixed condenser construction is to devise a method of securely clamping the plates together so that the capacity value can be relied upon to remain constant. In the Therla condenser a hard, thick piece of metal is wrapped over the condenser with the edges clamped down securely over the plates with sufficient pressure to prevent air gaps in the dielectric. The plates are of fairly thick brass and clamped together by means of eyelets. It is intended that the condenser should be carried by the instrument wiring, and for this purpose three connecting tags are available at each of the terminals.

**INTERCHANGEABLE FIXED CONDENSERS.**

Messrs. Peto-Scott, Ltd., 77, City Road, London, E.C.1, have evolved a method of mounting fixed condensers which should prove of great value to experimenters. It will be seen from our illustration that the condensers, which are of the mica dielec-

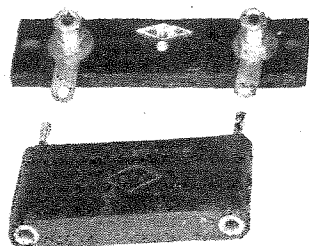

Interchangeable condenser of Messrs. Peto-Scott. Condensers can be assembled in parallel as required.

tric type, are mounted in hollow mouldings provided at each end with combined plugs and sockets. Thus, any number of condensers may be connected together to build up a required capacity.

It is interesting to note that the condensers are manufactured for Messrs. Peto-Scott by the Dubilier Condenser Co., Ltd., and their accuracy is guaranteed.

**THE CELLULITE VALVE WINDOW.**

Made of non-inflammable celluloid in various colours, this valve window is designed so that it is only necessary to drill a clearance hole in the panel and

press the outer ring on to the projecting portion of the window

It is a product of the Cellulite Manu-

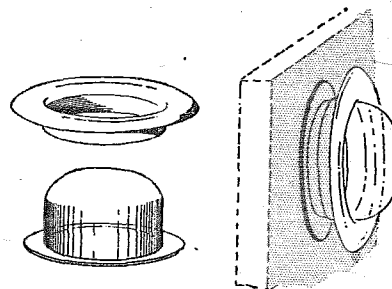

Method of fixing Cellulite valve windows.

facturing Co., of Knott's Green Road, London, E.10.

**THE KRA UNIT DOUBLE FILAMENT RESISTANCE.**

Where panel space is limited, the use of this double filament resistance can be recommended. The resistance windings are concentric, one contact being controlled by the large knob and the other by the smaller knob operating through a hollow spindle.

Although the resistance proper consists of a wide spiral wound in the usual spring formation, it is forced into a slot slightly narrower than its diameter. As a result, the turns of wire are forced over sideways and the spiral lies obliquely in the slot. By this means a smoother movement is obtained, and the revolving arms traverse the wire, making a reliable and even contact.

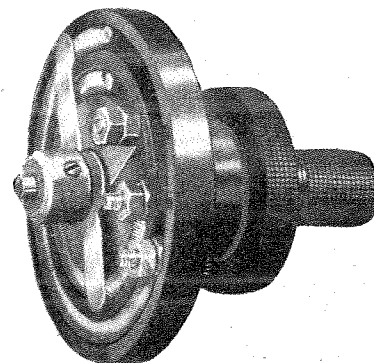

The Kra filament resistance for controlling the filament current of two valves.

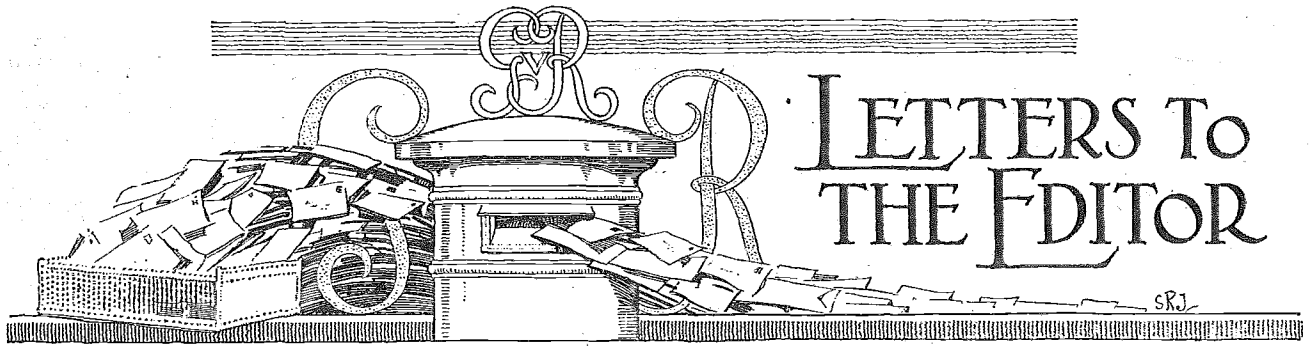

# LETTERS TO THE EDITOR

The Editor does not hold himself responsible for the opinions of his correspondents.

Correspondence should be addressed to the Editor, "The Wireless World," 139-140, Fleet Street, E.C.3, and must be accompanied by the writer's name and address.

## DURBAN HEARD IN ENGLAND.

Sir,—Your readers may be interested to hear that I have received a report from British 2KK, Radio House, Wilson Road, Smethwick, Staffs, that the talk on "Brighton" from the Durban station on May 6th, mentioned in your recent issue, was heard with very good reception by that station at 8.15 p.m.

As I believe that this is only the second occasion when reception from Durban has been reported by a station in the British Isles, it is a matter of some general interest.

HENRY D. ROBERTS.

Brighton.

## DUETTISTS MILES APART.

Sir,—In your issue of April 15th a description is given of a recent experimental transmission from the Broadcasting Station at Johannesburg, in which the soloist and his accompanist were not within direct audition range of each other, and it is stated in a later issue that experiments on the same lines will be made by the B.B.C. in the near future.

Although these experiments are put forward as representing an entirely new line of radio development, we would point out that an exactly similar and entirely successful experiment was carried out at our Test Station—2PQ—in 1923. The items transmitted were flute solos, with pianoforte accompaniment, the two instrumentalists being in separate buildings about a quarter of a mile apart, exact synchronism being attained by precisely the same means as in the Johannesburg experiment, i.e., by each performer listening in on a frame aerial to the combined transmission. The transmission was carried out on 440 metres with a power input of about 35 watts, and was heard and reported on by many receiving stations within a radius of 25-30 miles. A modified system of grid control was employed, both grid coil and A.T.I. being tuned, and the grid swing reduced until the

aerial current was  $\frac{1}{\sqrt{2}}$  of the maximum, this being the value

required to permit equal power modulation both upward and downward. The grid of the oscillator was modulated by the flute in the usual way, but owing to attenuation of the accompaniment by passing over the land line and by other factors this was first put through a choke-coupled amplifier consisting of a T/30 valve fed from the same H.T. source as the oscillator.

Subsequently, these experiments were extended in collaboration with another station, 5IF, one performer being at each station, and the transmission being made simultaneously from the two stations on 440 and 200 metres respectively. The 200-metre transmission was modulated by the solo only, the 440-metre simultaneous transmission comprising both solo and accompaniment. At the time these experiments were made it was pointed out that a quartette or even a small orchestra could be distributed at a number of studios in various parts of the country, and still maintain perfect tempo and synchronism by means of a loud-speaker in each studio dealing with the combined transmission.

G. E. MORTLEY

(Technical Director, Mortley, Sprague & Co., Ltd.)  
Tunbridge Wells.

## QSL ACKNOWLEDGMENTS.

Sir,—I think Mr. S. Jamieson's idea of QSL cards for non-transmitters rather good. But will the amateurs to whom you send data reply or even acknowledge your report? I recently took it into my head to write some that I logged. I wrote to twenty-two English and French amateurs in one week. I have had but three acknowledgments.

Needless to say, I am a little disgusted at this.

If non-transmitters use Mr. Jamieson's suggested QSL cards, will transmitters appreciate them?  
R. E. F.  
Gateshead.

## CANADIAN AMATEUR WAVELENGTHS.

Sir,—The new waves for Canadian amateurs, effective April 1st, are as follows:—

4.69 to 5.35, 18.7 to 21.4, 37.5 to 42.8, 75.0 to 85.7, 150 to 200. 120 metres is also authorised for Canadian stations operating across Canada and for intercommunication work between Canadian stations only. It is not to be used for communication with stations in the United States. ICW and radiophone are restricted to the wave band between 170 metres and 180 metres.

In particular, European amateurs wishing to hear Canadian stations should listen for them on 120 metres every Thursday morning, starting at 5 a.m. G.M.T., as at that time weekly we hold what is known as "the Wednesday night prayer-meeting of Canadian amateurs," in which as many as possible across the country join.

KEITH RUSSELL  
Toronto. (Canadian General Manager, A.R.R.L.)

## "DEAD SPOTS" IN RECEPTION.

Sir,—I have come to the conclusion that "dead spots" are caused by the smoke from large towns sending up a wall of carbon. This would effectively screen radio waves, being a conductor and having the same influence as a sheet of metal.

As a matter of fact, a large number of our broadcasting stations have their aerials slung between large smoke stacks. The column of smoke inside the stack might easily form a wireless "shadow" which would spread out like a fan. I think this may be one of the causes of "dead spots."

Sutton Coldfield. DEREK SHANNON (5PX).

## DISTURBANCE ON KDKA'S SHORT WAVELENGTH.

Sir,—With reference to Mr. L. Stuart Bidmead's letter in *The Wireless World* of May 6th in which he doubts my surmise that the transmissions in question were relayed by radio, the following extract from a letter just received from KDKA now confirms my opinion:—

"The first Brunswick Hour was rebroadcast by KDKA, as at that time we had not been able to get our telephone line connection installed. The howls and squeals you heard can be accounted for in this way. Subsequent transmissions of this very attractive 'Hour' were direct from our station."

Glasgow. J. GORDON-RITCHIE.

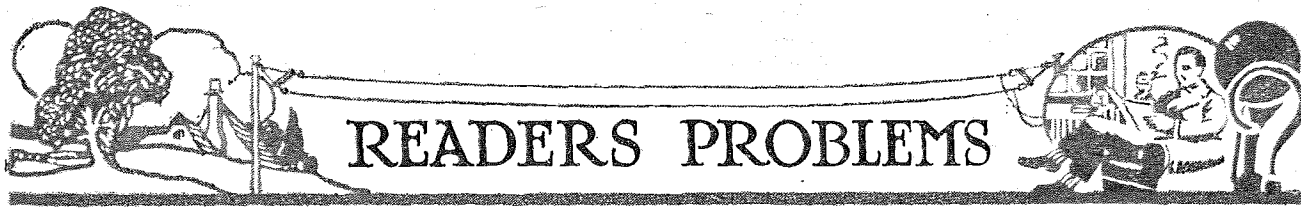

Readers Desiring to Consult "The Wireless World" Information Dept. should make use of the Coupon to be found in the Advertisement Pages.

**Eliminating Hand Capacity Effects in Variable Condensers.**

A READER has again raised the question concerning the correct connections of a variable condenser, he desiring to know whether the correct method of connecting a parallel aerial tuning condenser is to connect the fixed or moving plates to the earth terminals.

No absolutely definite rule can be given for this, as it depends on the construction of the variable condenser used. It is frequently stated that the moving plates should be connected to the earth terminal, since the hand (which is at earth potential) comes into very close proximity to the metallic shaft (to which are attached the moving plates) during the process of tuning. Although this is true, it must also be remembered that at the same time the hand is in close proximity to the metallic top end plate, and a capacity exists between the hand and this top end plate (which is in the majority of English condensers attached to the fixed plates) through the dielectric formed by the ebonite panel. The problem resolves itself, therefore, into a question as to whether the capacity effect between the hand and the fixed, or the hand and the moving plates is the stronger of the two. If the capacity between the hand and the fixed plates is the stronger, as it usually is in the case of metallic end plates, then the fixed plates should be connected to the earth terminal. If, however, the end plates are of ebonite, then the moving plates should be connected to the earth terminal, since the capacity between the hand and the shaft would then be the stronger. There will still, however, be some detrimental capacity between the hand and the fixed plates, as the end plate, being of ebonite, does not act as a screen between the hand and the actual fixed plates of the condenser.

Several designs of condenser have appeared on the market of late in which the fixed plates are entirely insulated from the framework of the condenser, the two end plates being of metal and connected to the moving vanes. In this case, of course, it is quite obvious that the moving plates must be connected to the point of earth potential. Then the capacity existing between the hand and the shaft and also the top end plate will have no detrimental effect, and, furthermore, the metallic top end plate will act as a screen between the hand and the fixed plates.

Although such a condenser goes a long way towards solving the difficulties of the annoying hand capacity effects observable in the critical tuning necessary to bring in long-distance stations, it must be remembered that it does not entirely do so. There are certain portions of a circuit, more especially in several varieties of the oscillator circuit in receivers of the superheterodyne type, where neither the fixed nor moving portions of the condenser are at earth potential with respect to H.F. currents. It seems, therefore, that there is room for a condenser in which neither the fixed nor the moving plates are in electrical connection with the framework or the end plates of the receiver. In an instrument of this type the framework could be connected to the earth terminal of the receiver.

In cases where a metallic geared vernier dial is used on any variable condenser, the moving plates should always be connected to the point of lowest potential. The metal dial would then act as a screen between the hand and the fixed plates.

of reaction of this circuit. If a receiver is made up from the diagram which we illustrate in Fig. 1, however, it will be found that the full benefits of reaction can be had; and, in fact, actual oscillation can be produced. Even with no reaction at all it will be found that sufficient capacity coupling is present in a receiver employing an H.F. stage to cause quite a considerable feed back to the grid of the first valve, whilst the addition of a small variable condenser connected between the plate of the detector valve and the aerial terminal will enable a smooth control over reaction to be obtainable.

o o o o

**The Question of Dielectric Losses.**

A READER who is constructing a superheterodyne receiver proposes to tune his intermediate stages to a wavelength of 10,000 metres by means of variable condensers, and has obtained some ex-Government solid dielectric variable condensers of reputable make for

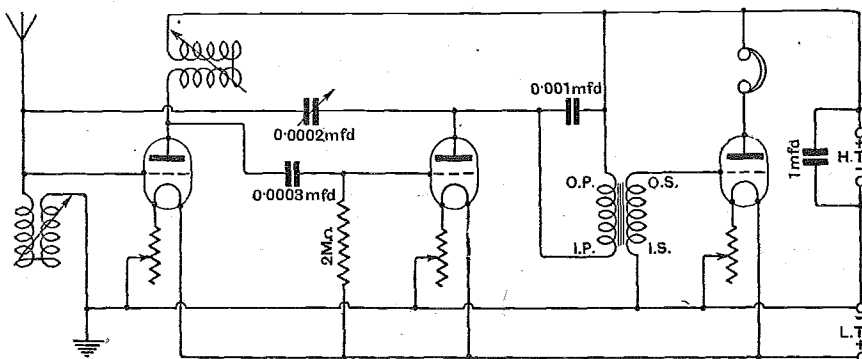

Fig. 1.—A three-valve set with variometer tuning and capacity reaction.

**Obtaining Reaction with Variometer Tuning.**

MANY readers desire to construct a receiver making use of reaction, and also an H.F. stage using variometers in place of the more conventional type of inductance and tuning condensers. It must be admitted that a receiver employing variometer tuning can be made considerably more attractive in appearance than one employing the "plug-in" type of interchangeable inductance. The great difficulty which readers come up against, however, is in the application

of these. He wishes to know whether these will be suitable, or whether it will be preferable to use air dielectric condensers in order to avoid losses due to dielectric hysteresis.

The solid dielectric condensers will be quite suitable, and no advantage would be gained by using air-spaced condensers, since at a frequency of 30 kilocycles the losses due to the solid dielectric would be negligible. This, of course, refers only to the condensers tuning the intermediate stages. It must be remembered that the condensers tuning the aerial and oscillator circuits are required to deal with

short wavelengths, and so the requirements of their design is vastly different from those of any condensers in the long wave amplifier.

of an ordinary tuned stage of H.F. will give a far greater amount of reserve power in hand, thus enabling a far less critical value of reaction to be used, but

circuit which will be suitable for 5XX and the long-wave Continental stations. It will be noticed that when the resistance is in use, the anode inductance is still in

**Short Wave Stations to Listen For.**

**A** READER who has been experimenting in short wave reception, more especially on the low wavelength of KDKA, asks for particulars of other American stations operating below the normal broadcasting wavelengths. We give below a list of these stations, giving the corresponding frequencies in kilocycles to the wavelengths mentioned, and also various other particulars concerning power rating, etc.

**An Easily Tuned Three-valve Receiver.**

**A** LTHOUGH it is possible to obtain reception from distant stations with an ordinary oscillating detector valve, it cannot be denied that the critical setting of reaction necessary to obtain distant stations is not suitable for placing in the hands of the ordinary broadcast listener, whose sole desire is to listen to the programmes from B.B.C. and Continental stations. The addition

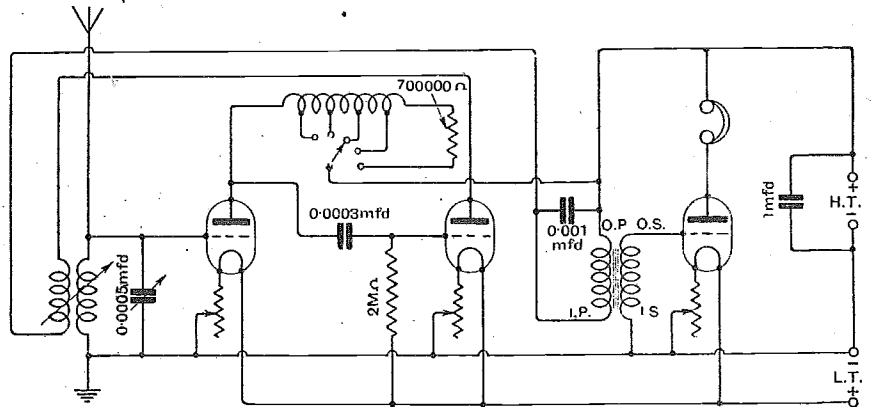

Fig. 2.—A three-valve receiver with two-knob tuning, giving one stage of H.F., valve detection and one stage of L.F.

unfortunately the addition of this H.F. stage adds an extra tuning control, which is in effect simplifying one feature of the receiver by adding a further complication. Insufficient attention has been paid to the design of receivers in which a semi-tuned H.F. stage is used.

circuit, but since the impedance of the resistance is extremely high in comparison to that of the reactance coil, no detrimental effect will be in evidence. If preferred, of course, the resistance may be attached to the other end of the coil, which will have the effect of eliminating the coil altogether on the long wavelengths.

The anode coil can consist of 120 turns of No. 40 S.S.C. resistance wire wound on a former 2 1/2 in. in diameter, tapings being taken at the 50th, 75th, 90th, and 120th turns.

We illustrate in Fig. 2 a circuit in which this principle is employed. It will be found that excellent amplification can be obtained from it, and the unskilled or semi-skilled person will probably get far better results from it than he would from a fully tuned stage, owing to its extreme simplicity in operation.

Provided that the anode reactance coil is carefully constructed, an amplification will be obtainable from it which will be equal to a goodly percentage of that obtainable from a fully tuned stage in skilled hands. The anode reactance, if made in accordance with the specification below, will easily cover the B.B.C. and lower Continental wavelength band with an ample margin of overlap, whilst by placing the switch on the final stud a resistance is brought into the anode cir-

**Obtaining H.T. from House Lighting Accumulators.**

**A** READER whose house is lighted from a bank of accumulators at a voltage of 60 has been very successfully using these accumulators as a source of supply to his three-valve set, but being desirous of adding a power amplifier, he wishes to know if it is possible to raise this voltage to 120 or more by means of a power transformer.

If the primary of a power transformer is connected to a source of D.C. supply, a momentary potential difference will appear at the secondary terminals when the primary circuit is made, but thereafter no power will be delivered at the secondary terminals, although a steady current is passing through the primary. In order to secure a potential difference at the secondary terminals, therefore, it will be necessary to vary the primary current by rapidly making and breaking the circuit by mechanical means. The output from the secondary would then have to be rectified and finally smoothed by an arrangement of chokes and condensers. Such an installation, however, would be costly and troublesome to maintain, and it would be far better to purchase a motor generator with a suitable input and output voltage.

**LIST OF UNITED STATES SHORT WAVE RADIO STATIONS.**

Fy-Kc.	Wave-length.	Location.	Owner.	Power.	Call Signal.
8560	21	Bellevue	U.S. Navy	10 Kw.	NKF
6970	35.03	Rocky Point, N.Y.	R.C.A.	20 Kw.	WOO
	43.02	New Brunswick, N.J.	Do.	20 Kw.	WIZ
6119	49	Sharon, Pa.	Westinghouse El. & Mfg. Co.	150 W.	WHD
4400	68.4	Pinecrest, Fla.	E. G. Watts, Jr.	5 W.	WRP
	68.4	Do.	Do.	100 W.	WRB
4070	74.03	Rocky Point, N.Y.	R.C.A.	20 Kw.	WON
3480	86.16	New Brunswick, N.J.	Do.	20 Kw.	WIR
3331	90	Kahuku, Hawaii	Do.	20 Kw.	KIO
3156	95	Belinas, Calif.	Do.	20 Kw.	KEL
2910	103	Tuckerton, N.J.	Do.	20 Kw.	WGH
2220	135	Rochester, N.Y.	Rochester Gas & Elec. Co.	750 W.	WJF
2188	137	Wilsonville, Pa.	Penn. Power & Light Co.	100 W.	WLF
	137	Allentown, Pa.	Do.	200 W.	WFC
	137	Williamsport, Pa.	Do.	100 W.	WPH
	137	Hauto, Pa.	Do.	100 W.	WDS
	137	Hazleton, Pa.	Do.	100 W.	WBJ
	137	Prackville, Pa.	Do.	100 W.	WCI
2142	140	Flint, Mich.	F. D. Fallain	500 W.	WGF
2100	143	Baltimore, Md.	Board of Fire Commissioners.	500 W.	WEQ
	143	Portable Station in California.	Los Angeles Examiner.	150 W.	KTA
	143	Do.	Do.	250 W.	KPK
	143	Do.	Tribune Publishing Co.	20 W.	KGA
	143	Washington, D.C.	Potomac Elec. Power Co.	50 W.	WJX
	143	Do.	Do.	50 W.	WJH
2070	145	Rochester, N.Y.	Rochester Gas & El. Co.	750 W.	WJF
2050	146	Portable Station in California.	Goldwyn Producing Co.	10 W.	KYJ
	146	Do.	Do.	5 W.	KYI
	146	Pysht, Wash.	Merrill & Ring Lb. Co.	5 W.	KJA
	146	Portable Station in Russell Reed, California.	—	50 W.	KFZ
	146	Do.	—	50 W.	KGV
	146	Do.	Pratt & Dutro	500 W.	KYX
	146	Do.	Do.	100 W.	KZI
1480	292.3	Harrisburg, Pa.	Penn. State Police	500 W.	WBAK
	202.3	Butler, Pa.	Do.	250 W.	WBR
	202.3	Wyoming, Pa.	Do.	100 W.	WDX
1200	238	Honolulu, Hawaii	Hawaiian Pineapple Co.	50 W.	KYB
1040	288	Kaunapalapu, Hawaii.	Do.	50 W.	KRQ



# The Wireless AND RADIO REVIEW World

No. 304.

WEDNESDAY, JUNE 10TH, 1925.

VOL. XVI. No. 18.

Assistant Editor:  
F. H. HAYNES.

Editor:  
HUGH S. POCOCK.

Assistant Editor:  
W. JAMES.

Editorial Offices: 139-40, FLEET STREET, LONDON, E.C.4

Telephone: City 4011 (3 lines).

Advertising and Publishing Offices: DORSET HOUSE, TUDOR STREET, LONDON, E.C.4.

Telephone: City 2847 (13 lines).

Telegrams: "Ethaworld, Fleet, London."

COVENTRY: Hertford Street.

BIRMINGHAM: Guildhall Buildings, Navigation Street.

MANCHESTER: 199, Deansgate.

Telegrams: "Cyclist Coventry."  
Telephone: 10 Coventry.

Telegrams: "Autopress, Birmingham."  
Telephone: 2970 and 2971 Midland.

Telegrams: "Hiffe, Manchester."  
Telephone: 8970 and 8971 City.

Subscription Rates: Home, £1 1s. 8d.; Canada, £1 1s. 8d.; other countries abroad, £1 3s. 10d. per annum.

As many of the circuits and apparatus described in these pages are covered by patents, readers are advised, before making use of them, to satisfy themselves that they would not be infringing patents.

## FUTURE DEVELOPMENTS OF BROADCASTING.

IF we are inclined to look upon broadcasting at the present day as bordering on perfection, then we are not exercising our imagination sufficiently to visualise the possible developments which may take place within the next few years. In our opinion, we have so far only touched the fringe of the possibilities which broadcasting can provide in the future, and it may reasonably be assumed that five years hence, on looking back, the uses which have been found for broadcasting to-day will look very trivial in comparison with the applications of the future.

At the moment broadcasting is being applied to provide entertainment and, to a limited extent, a means of education. The value of the service as a medium for disseminating news is very small indeed, by reason of the fact that the newspaper Press has been strong enough to protect its interests in this direction and ensure that no activities of broadcasting shall encroach on the monopoly of the newspaper world. But artificial barriers to progress seldom last long, and one cannot imagine that in the old days, by virtue of any influence which the coaching interests had with the Government of the day, it would have been possible to have established any form of contract to prevent the development of railways, nor could the railway companies of to-day expect that any sane Government would listen to a complaint against the transport of passengers and goods by motor road vehicles.

Broadcasting must be free to develop, but, if it is to expand and widen its activities and overcome artificial barriers to progress, it must be able, at the same time, to devise the means of combating its own limitations.

One of the limitations of broadcasting to-day is that stations are not able to disseminate information except at definite hours when it has been announced that the stations will transmit, for the reason that the audience would not be there, because sets would not be in operation ready to receive.

A very interesting but simple piece of apparatus is described in the present issue which may be attached as an accessory to any valve receiver and will switch on the valves and set the apparatus in operation automatically when the broadcasting station starts up, and again it will close down the apparatus when broadcasting ceases. The particular type of experimental set embodying this principle, which is described in this issue, will operate a valve receiver wherever strong crystal reception is obtainable, and, employing the same principle, it would be possible to construct sets in this way with varying sensitivity according to the distance of the transmitting station from the receiver.

We believe that the broadcast receiver of the future will be required to operate automatically with the incoming signal, for only with such an arrangement will the broadcasting station be able to transmit news or other information at any time, with the assurance that listeners will be able to receive their announcements.

### CONTENTS.

	PAGE
EDITORIAL VIEWS ... ..	563
A WIRELESS SELF-STARTER ... ..	564
By A. P. Castellain.	
THREE-VALVE UNIT RECEIVER ... ..	567
By R. H. Cook.	
READERS' NOVELTIES ... ..	571
POST OFFICE POINT-TO-POINT SERVICES ... ..	573
By Lt.-Col. Chetwode Crawley.	
CURRENT TOPICS ... ..	576
CONNECTING UP AN INTERVAL VALVE TRANSFORMER ... ..	578
By P. W. Willans.	
BROADCAST BREVITIES ... ..	581
RECEIVER FOR KDKA ... ..	583
By F. W. Danzelman.	
SELECTIVE FOUR-VALVE BROADCAST RECEIVER (concluded) ... ..	585
By W. James.	
NEWS FROM THE CLUBS ... ..	588
NEW APPARATUS ... ..	589
INTERFERENCE FROM ADJACENT AERIALS (concluded) ... ..	591
By W. H. F. Griffiths.	
LETTERS TO THE EDITOR ... ..	593
READERS' PROBLEMS ... ..	595

# A WIRELESS SELF-STARTER

An Automatic Switch  
for  
Broadcast Receivers.

By  
A. P. CASTELLAIN,  
B.Sc., A.C.G.I., D.I.C.

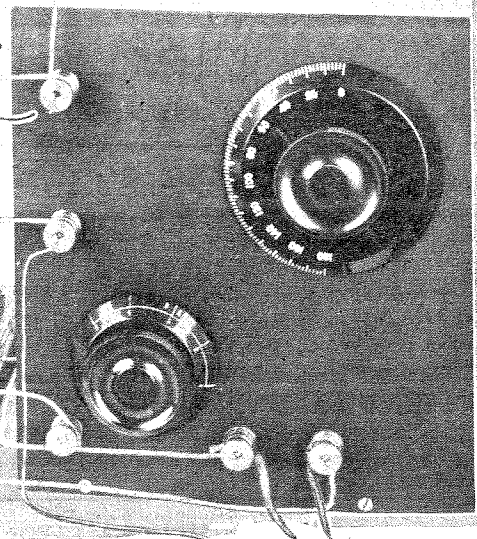
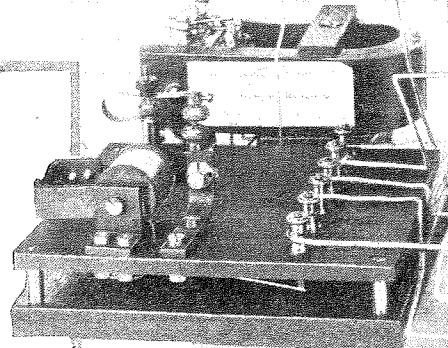

THE author's ideal of a broadcast receiving set is one which is unobtrusive, requires no skilled attention, and which gives unflinching service as a musical instrument. In his opinion the set and auxiliary apparatus should not be visible at all, and the loud-speakers themselves, which should be of the hornless type and two to every normal sized room, should not be blatantly visible. The only controls should be a switch for starting purposes and a strength control for the loud-speakers. This might easily be arranged with one small knob placed in some convenient position in every room having loud-speakers. This type of set would probably not be approved of by some, as there are at least two kinds of broadcast listeners: those who want to hear the programme, and those who like to twiddle knobs and get as many stations as possible. Two totally different types of sets are required for these two types of listeners; and this article is concerned almost entirely with the first kind. Of course, such a set would only receive the local station, but in the author's own experience, this is absolutely sufficient provided the set can be relied on to give continuous service when operated by a single switch similar to an ordinary electric light switch.

### Good Transformers Essential.

There is more in the last statement than would appear at first sight—one would say that it is easy enough to make a set with a single turn on control—so it is; but, and this is where the snag comes in, unless the components are properly chosen the set will not function indefinitely without trouble.

Switching a set full on brings its own little troubles—in the days before dull emitters, valve filaments used to object to this treatment, and only give a life of about a quarter to a tenth of the usual normal when a filament

rhostat was used. Also interval transformers did not seem to like the continual switching on and off, and their primaries burnt out. It may here be remarked that an H.T. voltage of about 130-150 was used in order to obtain pure L.F. amplification, and this, no doubt, had much to do with the destruction of transformers. However, it is essential to use a high value of H.T. for distortionless amplification, so that a transformer had to be found which would stand this treatment.

The author had three transformers of two very well-known (and expensive) makes go in this way in the first year and a half of broadcasting. One of these was returned to the makers as it had broken down before its guarantee had expired, and they changed it for a new one, which went in the same way within two months.

It would seem advisable for transformer primaries to be wound with thicker wire, or, at any rate, for the end turns to be better insulated.

The transformer at present in use has a primary of thick wire, and has given good service.

Now there is one thing that is likely to happen with a concealed receiving set, and that is that it will be left on all night several times during the course of its existence. Of course, this will not do any damage, but it is a waste of battery power, besides being rather annoying when discovered. This is where the automatic switch comes in.

### The Automatic Switch.

The principle of the switch is as follows:—A crystal rectifier in series with the coil of a sensitive relay is connected in parallel with the aerial tuning coil just in the same way that an ordinary crystal set is concerned, with the relay taking the place of the phones.

*A loud-speaker set which could start up automatically when the local station commenced its programme and switch itself off when the programme was finished, would be the last word in luxury, yet it is a comparatively simple matter to make such a set if the local station is received at good strength in the telephones when a crystal rectifier is used.*

**A Wireless Self-Starter.—**

A typical instrument consists of a fine wire coil mounted between the poles of a powerful horseshoe magnet. The coil turns when a current is passed through it, and in so doing compresses a small hair spring, which returns the coil to its original position as soon as the current through

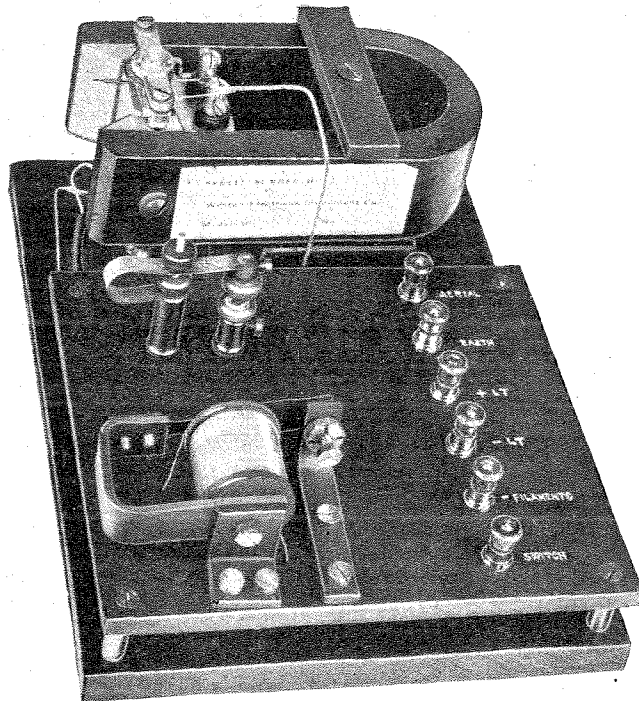

The complete automatic switch. At the top, the Weston relay; centre, the crystal detector; and below, the second relay.

it stops. Fixed to the coil is a small metal arm, which makes contact with a stop when the coil turns. Connections are made to the arm and stop for the circuit to be controlled.

A relay to operate with the aerial current from a local broadcast station must be a very sensitive instrument and the coil must be very light and easy to move, so that the arm and contact will not usually be substantial enough to deal with currents of the order of an ampere, or even if they are, the arm would not be pressing hard enough on the contact to pass this current without quite a considerable loss. A certain pressure is required between two

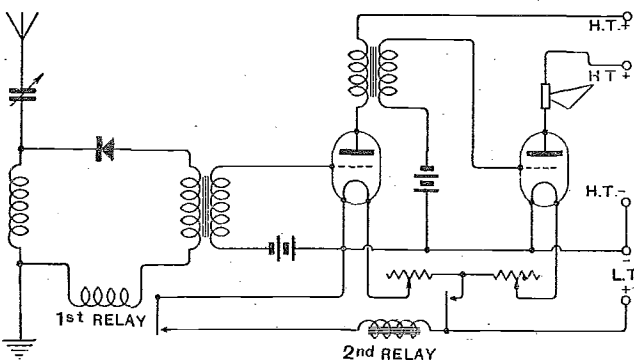

Fig. 1.—Connections of the automatic switch to a receiver having a crystal detector and note magnifier.

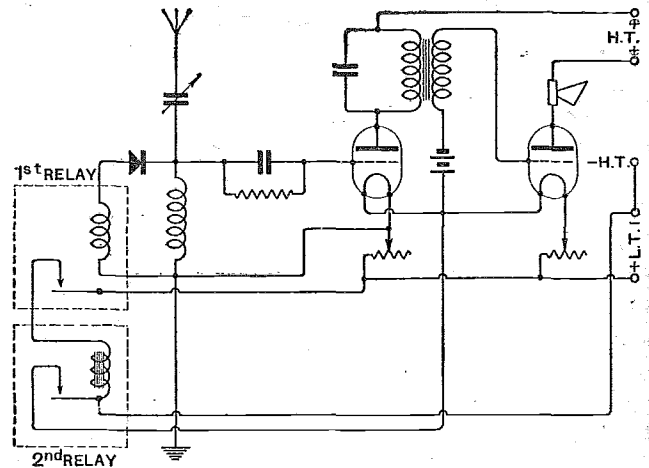

Fig. 2.—Method of connecting the automatic switch to a valve receiver.

metal surfaces before they are in good electrical contact, as there seems to be an insulating film formed on the surface which has to be broken down by pressure each time the contact is made. All that is holding the relay arm against the stop is the received current in the aerial, and there would usually not be enough power here to obtain a really good contact.

What has to be done, therefore, is to use another and more robust relay which is operated by the first relay. The latter closes a circuit containing the coil of the second relay and a battery which provides sufficient power to keep the second relay contacts closed at considerable pressure. This second relay controls the valve filament current.

If the set for which the automatic switch is required is a crystal one followed by low-frequency amplifiers, very little change will have to be made to it. The first relay coil will have to be put in series with the primary of the first low-frequency transformer.

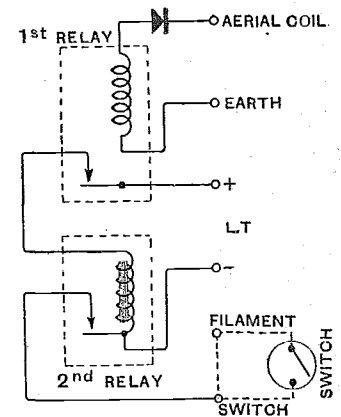

Fig. 3.—The arrangement of the terminals on the switching device.

The circuit will be as shown in Fig. 1.

It will be noticed that the filament battery itself is used to provide power for the second relay, which does away with the bother of an extra battery, and does not make much additional load on the battery if the second relay coil is correctly designed.

If the set uses a valve detector, then the circuit will be somewhat different, as shown in Fig. 2.

**Arrangement of the Switch.**

The construction of a switch suitable for connecting to an existing valve set will be described. For the first relay a Weston relay is used. This may be purchased at a good many wireless shops for about 10s. 6d.

**A Wireless Self-Starter.—**

The second relay may be built up as described, or an ordinary electric bell movement with the vibrating contact removed may be used.

A permanent crystal detector will be required, but a perikon combination (zincite-bornite) will do quite well for this in lieu of a commercial permanent detector if the crystals are mounted so that they can be pressed firmly together.

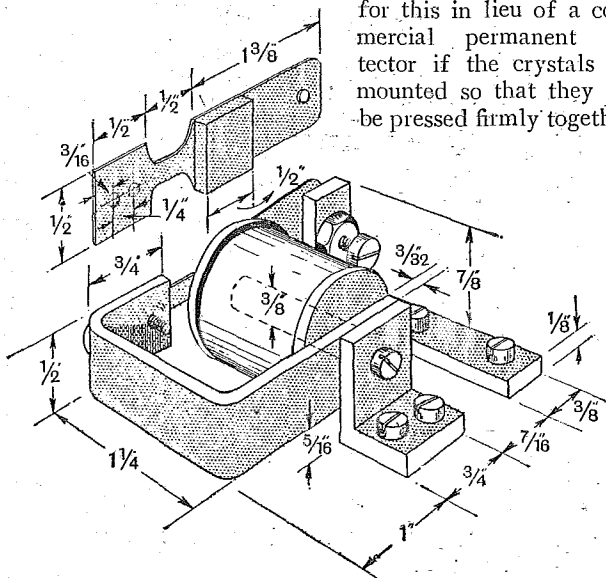
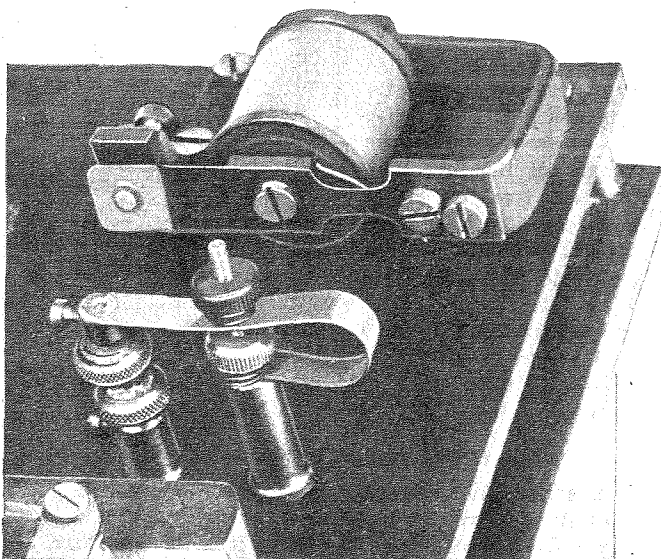

Fig. 4.—Details of the construction of the second relay which switches on the filaments of the receiver.

The actual circuit of the switch is given in Fig. 3, which is really Fig. 2 redrawn with the set left out.

The Weston relay will probably need no adjustment when bought, but the air gap in which the coil moves may be found to contain small particles of steel, which may be removed by blowing or by means of a stiff feather. The coil should not have much vertical play in its bearings, but it must be able to turn freely. The relay stops should be screwed up until the movement of the arm on the coil is limited to about 1/10 in. Both stops should be



The second relay and crystal detector.

connected together, as then it does not matter which way round the crystal is.

The extra terminal marked switch is added, in case the set is required to be switched off during the programme. The switch, which may be an ordinary tumbler switch, is connected to the last two terminals (as shown by dotted lines in Fig. 3). If sparking occurs, a 1 mfd. Mansbridge condenser should be shunted across the Weston relay contacts.

**Construction.**

The second relay should be made up first of all. An ebonite or wood bobbin to the approximate dimensions given in the sketches in Fig. 4 should be procured and wound full of No. 28 D.S.C. (or 30 D.C.C.) if the filament battery is 2 volts, or of No. 34 D.S.C. (or 36 D.C.C.) if the battery is a 4-volt one.

In order to drill holes through the spring steel armature, it is first necessary to punch a small hole through in the required position with a sharp centre punch. If this is not done, the drill will be found to suffer and will be badly blunted. The relay contacts should be made

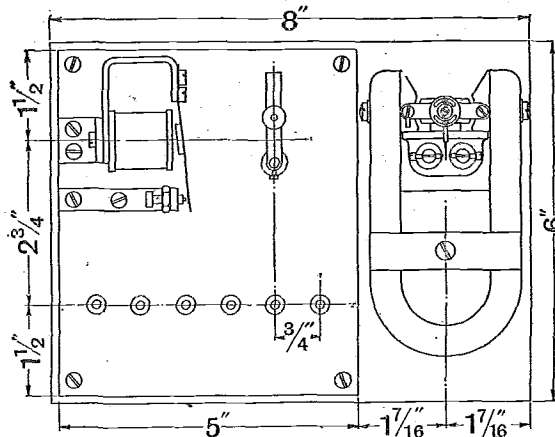

Fig. 5.—Arrangement of the component parts of the automatic switch.

from platinum or tungsten in order to give good service. Small rivets suitable for the purpose may be obtained from most electrical dealers, or, failing these, a short length of No. 20 platinum wire will do—an inch will make about a dozen contacts.

It is quite often possible to use the contacts from an old electric bell; the better-class ones are made of platinum.

The sketches in Fig. 5 should give sufficient information for the reader to make up the switch without further difficulty.

As to power used, the relay made by the author takes 120 milliamps. at 2 volts, and gives a very reliable contact. The normal filament current taken by the valves (DER and DE6) is 0.8 amps., so that an extra 0.12 amps. will not materially shorten the time between charges. A lightning arrester, such as the Climax or Siemens, should be permanently connected between aerial and earth, preferably outside the house.

The switch is a useful and amusing article to have on a permanent broadcast receiver, the amusing part being when it is demonstrated for the first time to friends.

# THREE VALVE UNIT RECEIVER.

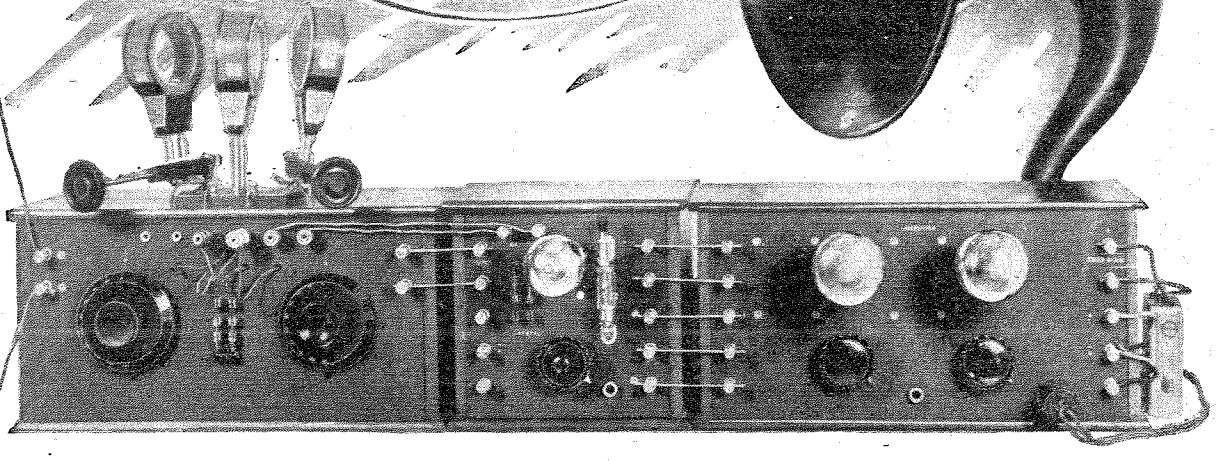

A Receiver for All Wavelengths with Valve or Crystal Detector and Two L.F. Amplifiers.

By R. H. COOK.

THE three-valve receiver described here is the result of an attempt to provide a set which is equally applicable for the reception of broadcast transmissions and long- or short-wave Morse signals.

For the sake of convenience, it was decided to build the set in three units—the tuner, the detector, and the note magnifier. The principle of the receiver may be understood by referring to Fig. 1. On the left is the tuner. This has two tuning condensers, three plug-in coils, plugs and sockets, and a series-parallel switch.

The series-parallel switch is connected to put the aerial tuning condenser in series or parallel with the aerial tuning coil. When good selectivity is desired, the 0.0005 mfd. condenser can be plugged across the centre coil, and the output terminals connected to this secondary circuit. The third coil can then be used for reaction by connecting the two terminals R on the detector panel to the two sockets provided below the coil.

The output terminals of the tuner are connected to the terminals marked "input" on the detector. A valve

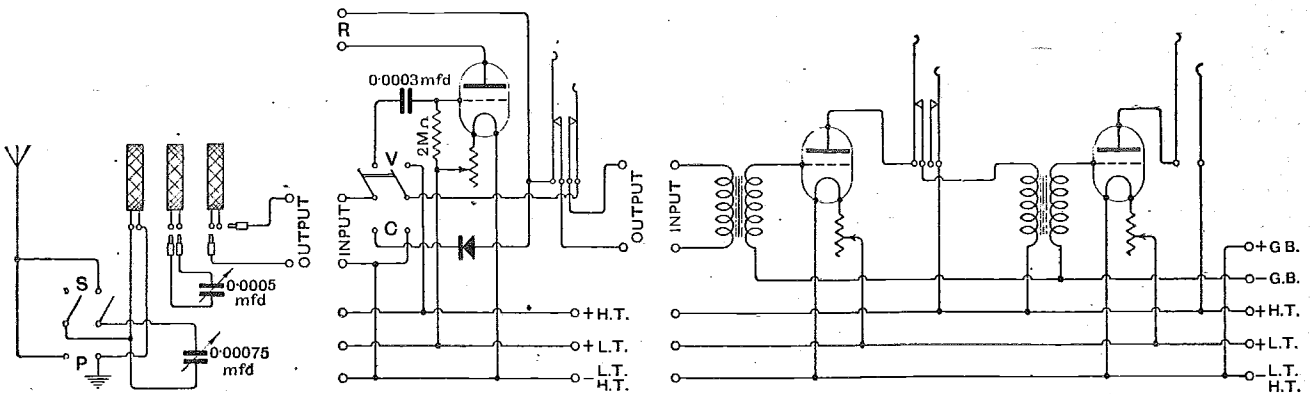

Fig. 1.—Theoretical connections of the receiver. On the left, the tuner; centre, the detector; and right, the L.F. amplifier.

**Three-valve Unit Receiver.—**

or crystal detector may be used by putting the switch in position V or C. When the valve detector is used, reaction may, of course, be employed by connecting the terminals marked R to the tuner. Telephones may be connected to the detector by putting the telephone plug in the jack provided.

The third unit of the receiver is a two-valve low-frequency amplifier, which is connected up in the usual manner. Jacks are connected to the valves to enable one to connect a loud-speaker to the first or second note magnifier.

**The Tuner.**

As the tuner had to be able to tune in all wavelengths, plug-in coils and a three-coil

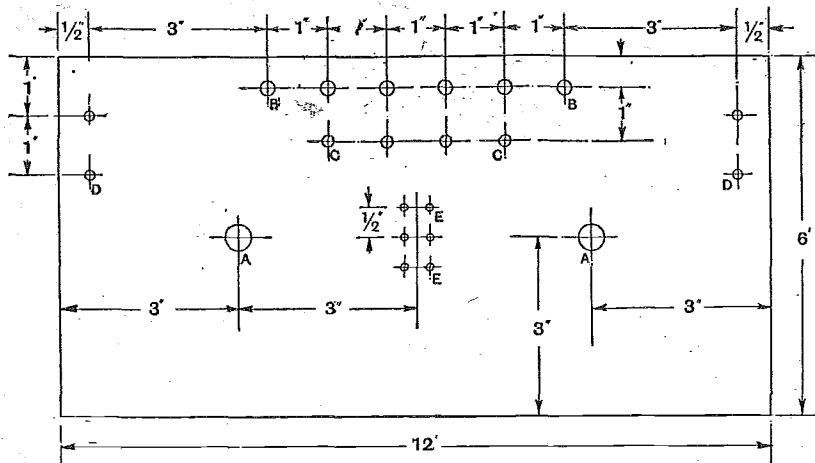
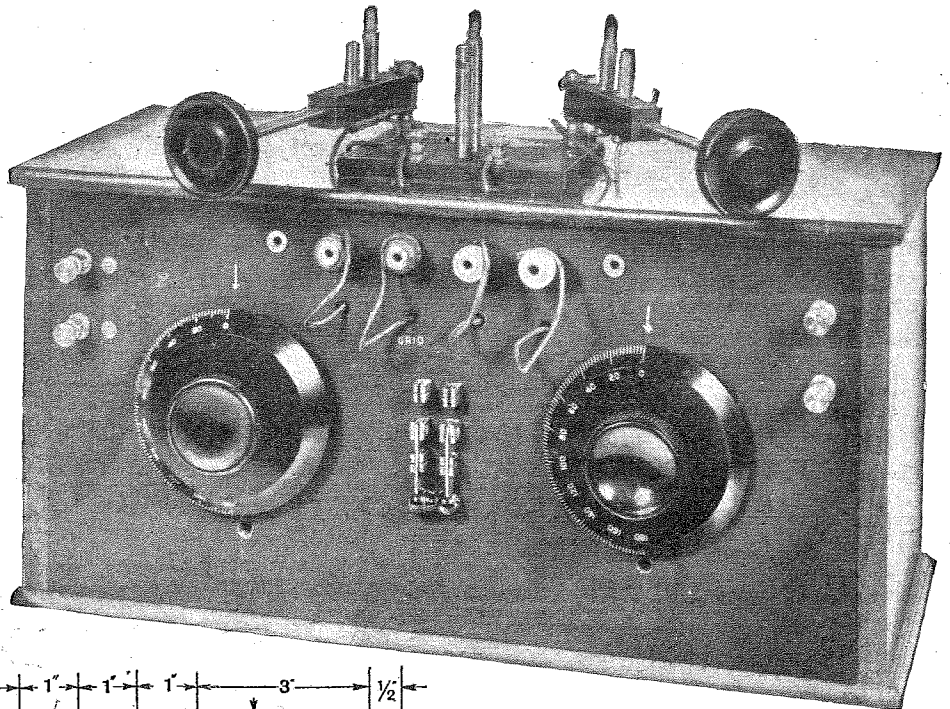

Fig. 2.—Drilling details of the front panel of the tuner. A, 7/16in. dia.; B, 1/4in. dia.; C, 3/16in. dia.; D, 5/32in. dia. and countersunk for No. 4 B.A. screws; E, 1/8in. dia. and countersunk for No. 6 B.A. screws.

The tuner. The right-hand pair of plugs are joined to the output terminals.

the other two to the 0.0005 mfd. condenser. The remainder of the connections are easily seen from Fig. 3. For direct-coupled tuning, the plugs joined to the output terminals are plugged into the pair of sockets joined to the aerial coil, while for loose coupling these plugs are connected to the centre sockets.

The 0.0005 mfd. condenser can be used for tuning the secondary circuit by putting the plugs joined to it into the sockets of the secondary coil, or it can be used to tune the reaction coil.

holder were employed. This unit is arranged as indicated in the photographs and Figs. 2 and 3. On the top of the case is mounted the three-coil holder, the particular holder used being of a construction permitting very fine adjustment of coupling to be made.

Mounted on the panel are the two tuning condensers, capacities 0.00075 and 0.0005 mfd., the series-parallel switch, two terminals for the aerial and earth connection, and two marked "output" for connecting to the detector. Six Clix sockets are fixed above the series-parallel switch, and are connected to the terminals of the three-coil holder. Four Clix plugs are used, two of them being connected by flexible wires to the output terminals, and

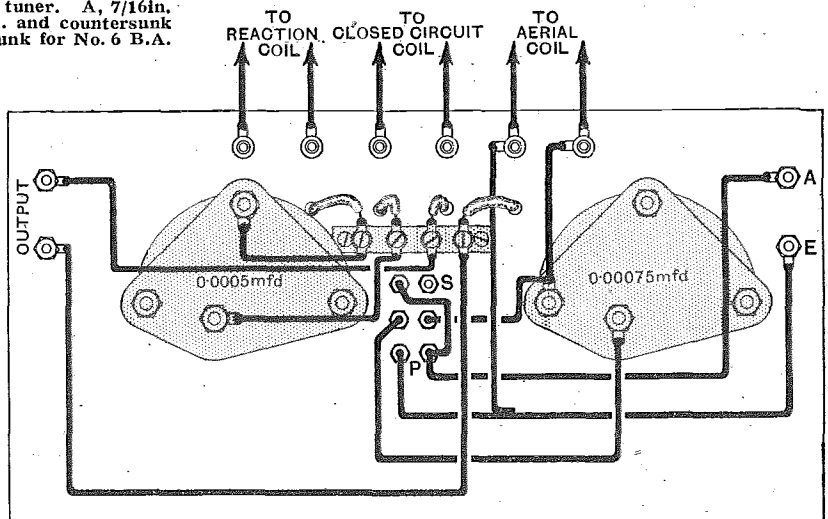

Fig. 3.—Wiring connections of the tuner. The six wires at the top are joined to the terminals of the three-coil holder.

**Three-valve Unit Receiver.—**

This unit is very easily constructed, and does not need a detailed description, although it might be mentioned that a small ebonite block carrying four No. 6 B.A. screws and tags, is secured to the back of the panel, as indicated in Fig. 3. The flexible connections to the plugs are taken from these tags.

*The following components are required for the tuner:—*

- 1 Ebonite panel 12in. × 6in. × 1/4in.
- 1 3-Coil holder. 1 0.00075 mfd. square law condenser. 1 0.0005 mfd. square law condenser. 1 Miniature D.P.D.T. switch (Radcom). 6 Clix sockets. 6 Clix plugs. 4 Terminals. 1 Case 12in. × 6in. × 6in.

**The Detector Panel.**

For the reception of the local broadcast transmissions there is no doubt that a crystal rectifier is quite satisfactory; therefore, in this instrument a crystal detector

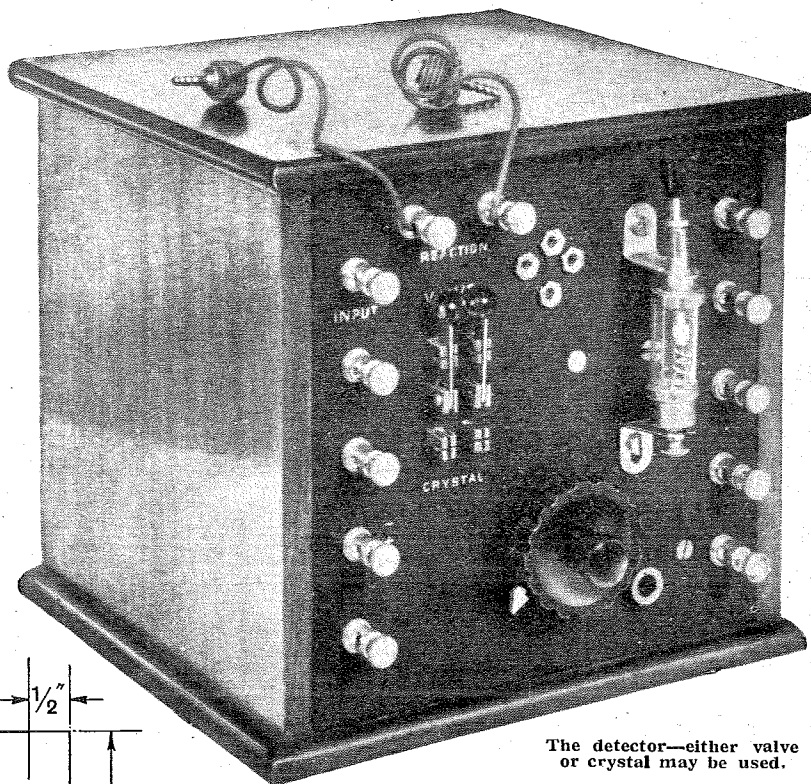

The detector—either valve or crystal may be used.

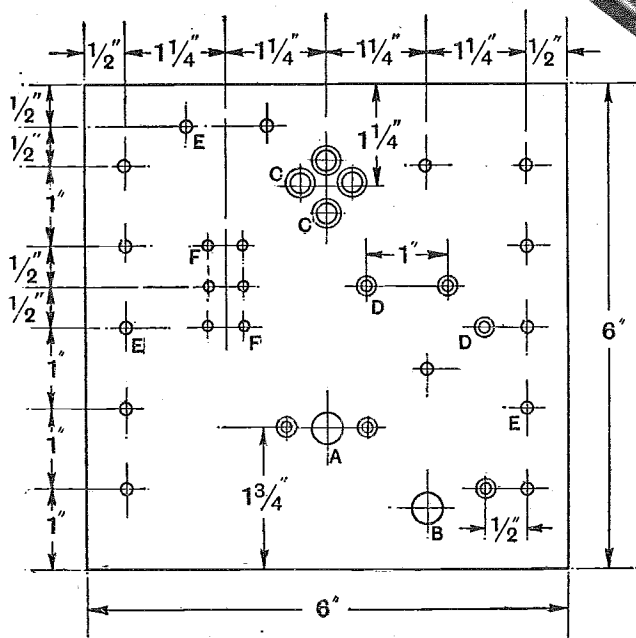

Fig. 4.—The detector panel. A, 7/32in. dia.; B, 3/8in. dia.; C, 1/4in. dia. and countersunk; D, 5/32in. dia. and countersunk for No. 4 B.A. screws; E, 5/32in. dia. for No. 4 B.A. screws; F, 1/8in. dia. for No. 6 B.A. screws.

is provided, and it is connected in the circuit when the switch provided on the detector panel is put in the position marked C (Fig. 1). The arrangement of the detector panel can be seen from the illustrations and Figs. 4 and 5. Fig. 4 gives the layout of the components on the panel, and Fig. 5 the wiring.

Referring to the illustrations, two rows of terminals will be seen, also a pair of terminals labelled "Reaction" at the top of the panel. On the left is the valve or crystal switch; in the centre the valve holder; on the right the crystal detector; and, below, the vernier filament rheostat

and telephone jack. These parts are all arranged on an ebonite panel measuring 6in. × 6in. × 1/4in., which allows plenty of room for the components.

When the tuner and detector units only are to be used, it is necessary to connect the "output" terminals of the tuner to the "input" of the detector, and put the telephone plug in the jack provided. With the switch set to "crystal," the crystal detector is connected, and the set may be tuned in the ordinary manner. If a valve detector is to be used, the switch should be put in its

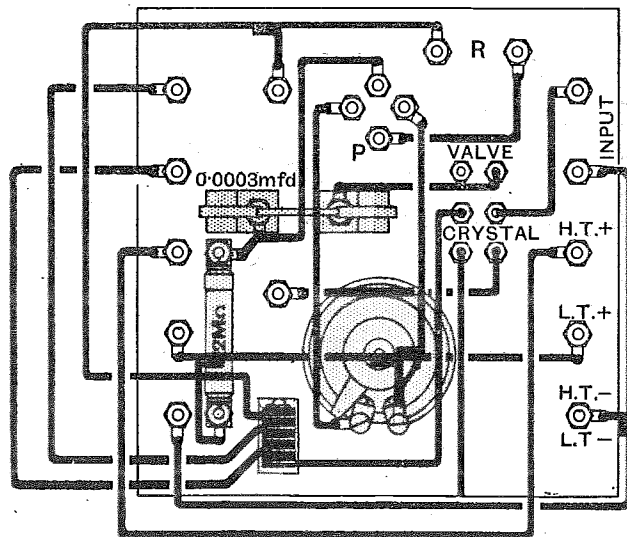

Fig. 5—Wiring connections of the detector unit.

**Three-valve Unit Receiver.**— upper position, and appropriate filament and plate batteries connected.

The following components are required for the detector:—

- 1 Ebonite panel 6in. × 6in. × 1/4in.
- 1 King rheostat with vernier.
- 4 Flush type valve sockets.
- 1 Crystal detector.
- 1 Miniature D.P.D.T. switch (Radcom).
- 1 Telephone jack.
- 1 0.0003 mfd. fixed condenser with clips (McMichael).
- 1 2 megohms grid leak with clips (Dubilier).
- 12 Terminals.
- 1 Case 6in. × 6in. × 6in.

**The L.F. Amplifier.**

The note magnifier panel has two transformer coupled valves. A panel 12in. × 6in. × 1/4in. is used, and mounted on it are the two filament resistances, two

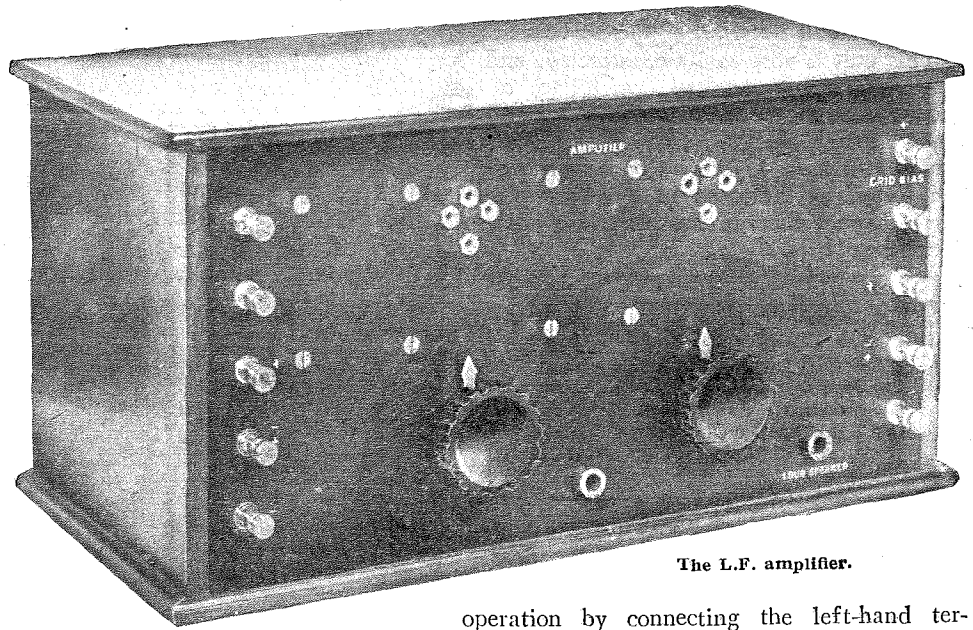

The L.F. amplifier.

operation by connecting the left-hand terminals to the corresponding terminals of the detector unit, and the loud-speaker may be connected in the plate circuit of the first or second note magnifier by putting the plug into the first or second jack.

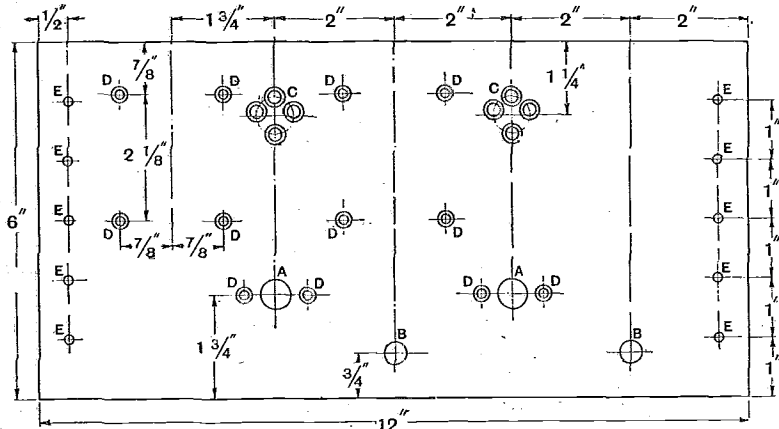

Fig. 6.—Drilling details of the L.F. amplifier panel. A, 7/16in. dia.; B, 3/8in. dia.; C, 1/4in. dia. and countersunk; D, 5/32in. dia. and countersunk for No. 4 B.A. screws; E, 5/32in. dia.

The following components are required for the amplifier:—

- 1 Panel 12in. × 6in. × 1/4in.
- 2 L.F. transformers (Sullivan's).
- 2 King rheostats.
- 8 Flush type valve sockets.
- 2 Telephone jacks.
- 10 Terminals.
- 1 Case 12in. × 6in. × 6in.
- Also 1/4lb. No. 16 tinned copper wire.
- Flexible wire.
- Number of 4 B.A. 5/8in. countersunk screws, with nuts.

With this receiver it is possible to receive a number of stations on a loud-speaker at good strength, and tuning is quite easy. When coupled circuit tuning is used, a little care will have to be exercised to secure the best results, but, by properly using the circuits, reasonably good selectivity should be obtained.

sets of valve sockets, two sets of terminals, two transformers, and a four-point and a two-point jack. These are arranged as indicated in Figs. 6 and 7. Valve sockets of the flush type are used, as clearly shown in the illustrations.

It will be noticed that the two upper terminals on the right-hand side are for the grid bias battery. When power valves are used with about 120 volts on their plates, a grid bias of about 6 volts should be used. As the grid bias battery is not called on to furnish a current, small dry cells may be employed.

The amplifier is put into

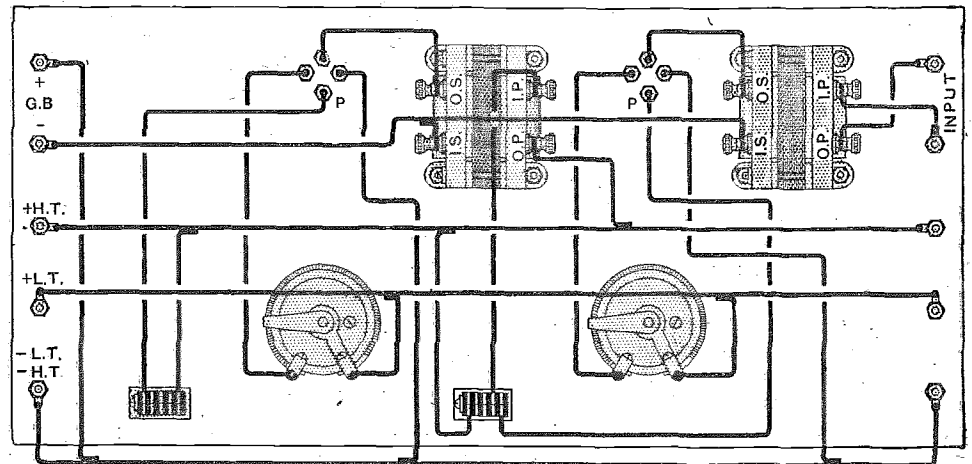
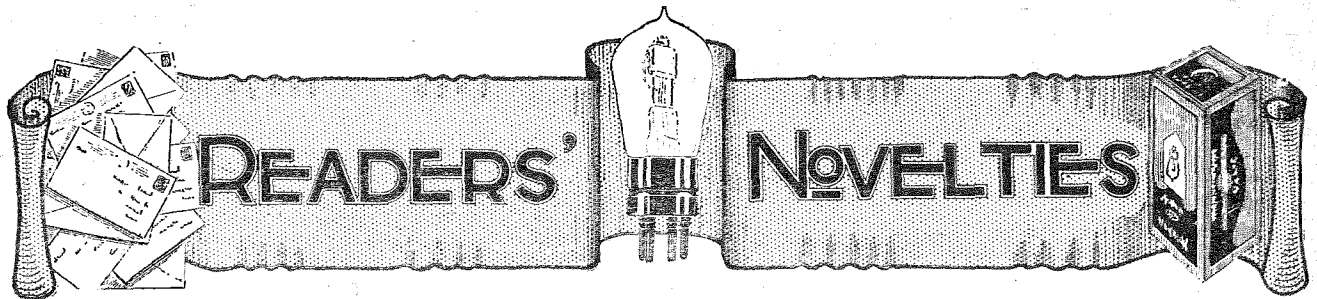

Fig. 7.—Wiring connections of the L.F. amplifier.





A Section Devoted to New Ideas and Practical Devices.

**AN EXPERIMENTAL COIL HOLDER.**

The expense of maintaining two coil holders, one for experimental work and one for use in a permanent set, may be avoided by fixing the coil holder on a detachable mounting so that it may be removed from the permanent set for experimental work.

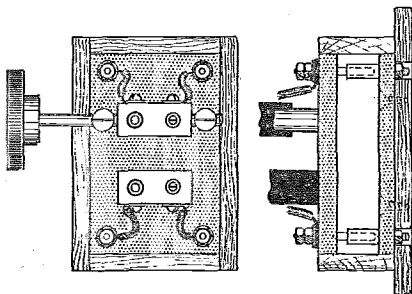

Fitting plug and socket connectors to a 2-coil holder panel.

The coil holder is mounted on an ebonite panel, to the underside of which are screwed plug connections fitting into sockets on the receiver panel. A wooden casing may be fitted round the sockets on the panel for the sake of appearance, and the ebonite platform can then be cut to fit this casing. Terminals are fitted to each of the plug connections on the platform, so that the coil holder can be easily removed from the receiver for experimental work on the bench.—F. T.

**CONSTRUCTION OF GRID LEAKS.**

Perhaps the simplest form of grid leak is a lead pencil line drawn on some solid insulating material. A resistance constructed in this way will give excellent results as a grid leak, as it will be called upon to carry only very small currents, and will not be likely to change in value through overheating.

The choice of a suitable insulating material upon which to draw the

pencil line is, however, of great importance. Most failures can be traced to the appearance of lateral cracks due to expansion or bending of the insulating base. Trouble from this source can be eliminated to a large extent by using ground glass as a base. It is not affected by changes of temperature to the same extent as ebonite, and is, of course, unlikely to give trouble through bending.

If glass already frosted is not available, it is convenient to use glass microscope slides and to frost these by rubbing them together in pairs with a paste made up with emery powder and water. The dimensions of these slides are 3 in. x 1 in., and a line drawn from end to end can be easily regulated in thickness to give the resistance usually employed as

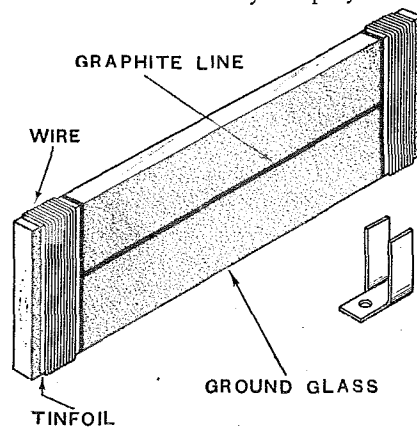

The use of a microscope slide in the construction of a grid leak.

grid leaks. The ends of the slide should be well blacked over with lead pencil and covered with several layers of tin foil, after which connection wires, preferably of tinned copper, may be bound round to keep the foil in position.—J. B.

**A COMBINED VERNIER ADJUSTMENT.**

The diagram shows how a large variable condenser was provided with

a vernier adjustment having two "degrees of freedom."

The condenser spindle was fitted with a vertical ebonite extension rod carrying at its upper end a stiff brass bracket. To this bracket was attached a two-plate vernier con-

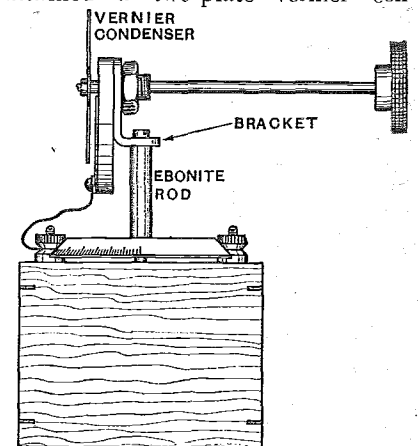

A ingenious arrangement for operating a vernier condenser by a lever which is also used to control the main condenser adjustment.

denser operated by a long spindle at right angles to the spindle of the main condenser. This spindle acts as an extension handle for the lateral movement of the main condenser vanes, while rotation of the same spindle provides a vernier adjustment of the capacity. The vernier condenser is connected through suitable flexible leads in parallel with the main condenser.—D. H. J.

**A CLIP CONNECTOR FOR TRANSMITTING COILS.**

The efficient operation of a transmitter depends very largely upon careful adjustment of the tapping points on the aerial inductance. It is not sufficient to be able to adjust the inductance in circuit to the nearest turn, and a clip by means of which the length of wire may be

adjusted to a fraction of an inch is necessary.

Many types of clip have been designed for this purpose, but the drawback with most is that they are apt to short circuit adjacent turns through inadequate insulation, and cannot be handled while the transmitter is working. An improved design which can be safely handled is shown in the diagram. An ebonite body A is turned from ebonite rod or tube with a tapered nose at one end. Through this a brass stem B protrudes, the end of which has been flattened and cut with a hacksaw to

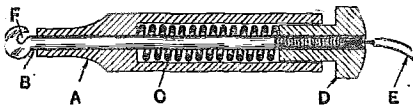

Suggested design for a clip used in making connections with the turns of an inductance.

form a hook which will pass over the inductance wire. A spiral spring C pressing on the ebonite cap D tends to pull the hook inwards, thus securing good contact with the inductance wire.—G. C. P.

o o o o

**COIL HOLDER ADJUSTMENT.**

A cone adjustment for moving coil holders is very effective, and provides an excellent control over the coupling.

The two coil arms are hinged and pulled in towards each other by means of elastic or a coil spring. The cone, which is rigidly mounted, can be screwed forward, thus gradually forcing apart the arms.

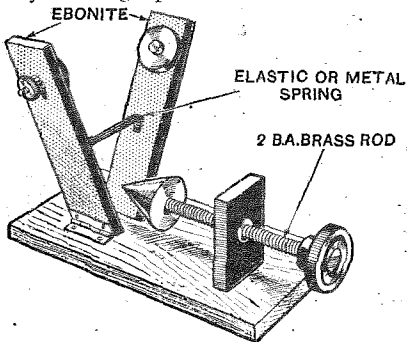

The coupling between coils carried on the ebonite pieces is controlled by driving the cone between them.

The success of this arrangement depends to a large extent upon the action of the hinge joints. There should be no appreciable side play, and for this reason it may be advisable to use adjustable pivots for the hinges.—T. C. E.

A 16

**SWITCHING H.F. VALVES.**

In receivers employing more than one stage of H.F. amplification it is desirable to vary the number of H.F. valves in accordance with the strength of the incoming signals from different stations. Switches always introduce troublesome stray capacities, and even when the design of the switch is such that the capacities in the switch itself are small, there still remains the extra wiring associated with the switch contacts.

Assuming that the valves used in the H.F. stages operate equally well as detectors, the system of connections illustrated in the diagram will be found to solve the stray capacity problem. The rectifying grid condenser and leak are built up in the form of a unit with two plug connections. Pairs of sockets spaced to take this unit are connected in the

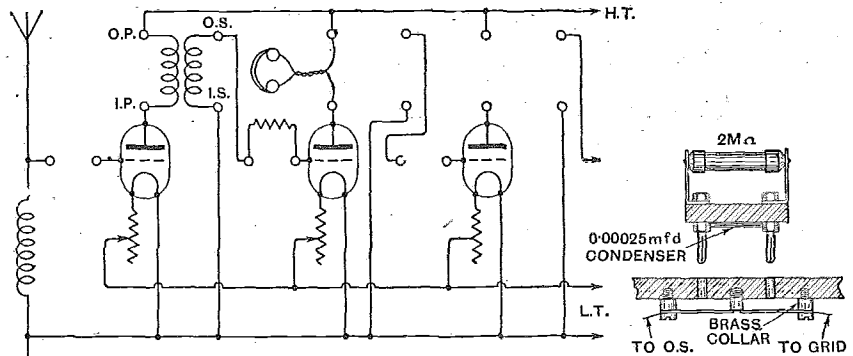

Switching of high frequency amplifying circuits.

grid circuit of each valve and are provided with spring contacts which short-circuit the sockets when the unit is withdrawn. Plug-in H.F. transformers are used to couple the valves, and a special two-pin telephone plug is made to fit the primary winding sockets.

Having decided upon the number

of H.F. valves to be used, the valve immediately following the last H.F. valve is converted into a detector by inserting the grid condenser and leak in the grid circuit and the telephones in the plate circuit. In the diagram the first valve operates as an H.F. amplifier and the second as a detector.—E. W. G.

o o o o

**STAYING AN AERIAL MAST.**

After an aerial mast has been erected the discovery is frequently made that additional guy wires are necessary if the mast is to remain standing during windy weather. If the mast is heavy, one hesitates before undertaking the arduous task of lowering and re-erecting it for the purpose of attaching the additional stays.

In all cases where an eye-bolt was used to secure the pulley, the guy

wires may be looped over the head of the mast with the aid of a notched piece of wood attached to the halyard. The wood should be about 2ft. in length, and should be tied to the halyard at A and B, so that the distance A C is slightly greater than the distance D E. The centre of the guy wire, which should be greater than twice the height of the

mast, is then placed in the notch and twisted until it passes over the eyebolt. A pull on the ends of the wire will settle it in position over the bolt, after which the two halves can be twisted together and secured to suitable anchors.

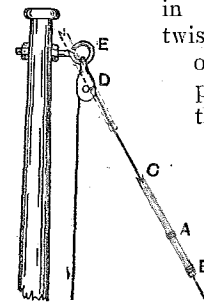

Guide rod for attaching guy wire.

—J. C. S.

20

**VALVES FOR IDEAS.**

Readers are invited to submit brief details, with rough sketches, where necessary, of devices of experimental interest for inclusion in this section: A receiving valve will be despatched to every reader whose idea is accepted for publication.

Letters should be addressed to the Editor, "Wireless World and Radio Review," 139, Fleet Street, London, E.C., and marked "Ideas."

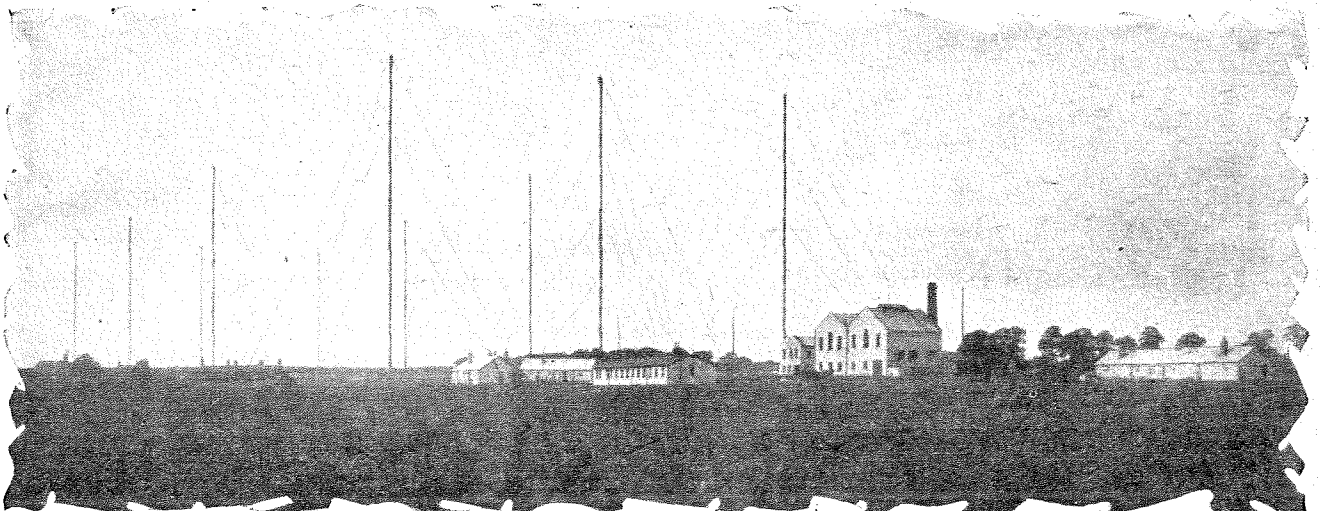

Leaffield Station.

## POST OFFICE POINT-TO-POINT SERVICES.

### Stations for Overseas Communication.

By Lt.-Col. CHETWODE CRAWLEY, M.I.E.E.

THE Oxford, Cairo, Northolt, and Stonehaven stations are used by the Post Office for point-to-point wireless services.

The Oxford Station consists of a transmitting station at Leaffield and a receiving station at Banbury. The erection of a station at Leaffield was commenced at the close of 1913, and was to form the English transmitting station for the Imperial chain of stations then contemplated, the first link in the chain being a similar station in Egypt, near Cairo. The receiving station to be worked in conjunction with Leaffield was to be at Devizes, and the receiving station for Cairo was to be at Abu Sueir, near Ismailia.

When war broke out the masts were in place at Leaffield and Devizes, and some were in place at Abu Zabal, the site of the Cairo station, but none had been erected at Abu Sueir. The scheme for an Imperial chain was soon abandoned, Leaffield and Devizes being used as receiving stations only, and Abu Zabal being installed with a 100 kw. arc transmitter as well as receiving apparatus.

After the war it was decided to erect up-to-date transmitting stations at Leaffield and Abu Zabal, utilising the old masts, and Banbury was chosen as more suitable than Devizes for receiving in conjunction with Leaffield under the new conditions. Some of the masts and huts at Devizes were utilised for the establishment at that place of the C.W. station for ship communication. The masts at Leaffield and Abu Zabal, ten at each station, are of the tubular steel pattern, 300ft. high, both stations being fitted with 250 kw. arc transmitters, and having the necessary power generated at the station.

As soon as the broadcast service commenced to operate in earnest it was found that harmonics and mush emitted from Leaffield were troublesome to listeners, especially

in the vicinity of the station, and they also interfered to some extent with the reception of ships' traffic at Devizes. This trouble has been eliminated by the installation of a coupled circuit for the Leaffield arc, which was previously fitted in the aerial. The magnitude of this alteration can be estimated when it is realised that the condenser alone for the coupled circuit weighs about 25 tons.

It might be thought that this coupled circuit would have resulted in a considerable increase in the power consumed over that required for the plain aerial arrangement, but, as a matter of fact, with the 12,350 metres wave there is no increase at all, and with the 8,750 metres wave the power consumed is actually less. It is interesting to note that in no other country are there any large coupled arcs working so satisfactorily as those at Leaffield.

The staff at Leaffield is a purely engineering one, as the station is operated from the General Post Office in London. Leaffield transmits on either a 12,350 or a 8,750 metres wave, according to which of the two is the more suitable for the communication on hand, but, generally speaking, the longer wave is more suitable for day transmissions and the shorter wave for night transmissions.

In signalling, marking and spacing waves are used, the variation taking place in the inductance of the primary of the coupled circuit, the tune of the aerial circuit remaining constant.

This station is used for transmitting commercial traffic to Abu Zabal, Banbury acting as the receiving station for the incoming traffic, which is retransmitted by land-line to the General Post Office in London. It also transmits press to Halifax, press and commercial traffic to ships at sea, and broadcasts Government *communiqués*.

**Post Office Point-to-Point Services.—****The Cairo Station.**

This station, which is at Abu Zabal, some fifteen miles from Cairo on the Ismailia Canal, is a simplex station: that is to say, it cannot, like the other Post Office point-to-point stations, send and receive simultaneously, as its transmitting and receiving stations are not separated from one another.

The installation is similar to that at Leafield, but a coupled transmitting circuit has not yet been fitted.

The wave used is 11,000 metres, and the station carries out commercial services with Oxford, Hanover and Basra.

**The Northolt Station.**

The Northolt station, near Harrow, is a medium-power transmitting station operated from the General Post Office in London, where the receiving sets working in conjunction with it are situated.

Four masts are used, three of them being wooden lattice work masts 450ft. high, and one a steel tubular mast 300ft. high. The power is obtained from the Uxbridge Power Supply Company.

A 40 kw. coupled circuit arc set and a valve set are fitted, the arcs, as at other Post Office stations, being in duplicate. The direct current supply for the arc installation is obtained by the use of motor generator sets, the supply for the valve set by transformers and rectifiers.

Water-cooled metal valves are used in the oscillator circuit.

The normal wave transmitted by the arc set is 6,950 metres, and by the valve set 5,780 metres, transmission on the arc set being effected by means of marking and spac-

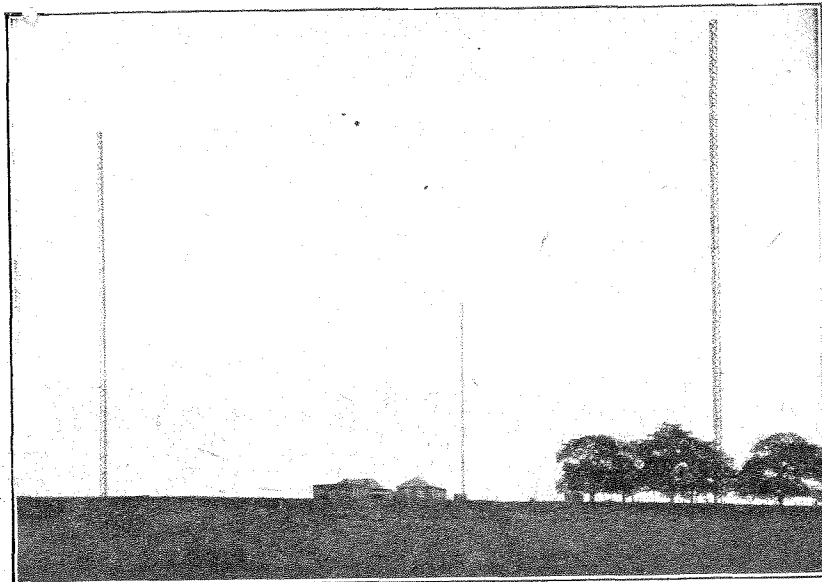

The aerials and buildings of the Northolt station.

ing waves, and on the valve set by a marking wave only. This station is used for transmission to European countries and to Halifax.

**The Stonehaven Station.**

The Stonehaven station is also a medium-power arc and valve station, operated on a 4,600 metres wave from London, over a land line some 500 miles long, similar to the Northolt station. Arcs rated at 25 kw. are installed, but the work is now normally carried out on the valve set. The power is generated at the station. The aerial is supported on six tubular steel masts 250ft. high.

For the reception work in connection with these point-to-point stations there are six sets at present in use at the General Post Office in London, in addition to the set at Banbury, high-speed automatic apparatus being normally used for both the transmission and reception of telegrams.

**The Rugby Station.**

The Post Office is erecting on a site of 900 acres at Hillmorton, about three miles from Rugby, what will be by far the most powerful station in England, and one of the most powerful in the world.

Twelve steel lattice-work masts, 820ft. high, are being erected, spaced a quarter of a mile apart.

Power is being supplied by the Leicestershire and Warwickshire Electric Power Co., and motor generators at the station are being arranged to allow of any d.c. voltage up to 18,000 being obtained.

The high-frequency generator will be made up of water-cooled valves, each with an output of 10 kw.

This station will have a world-wide

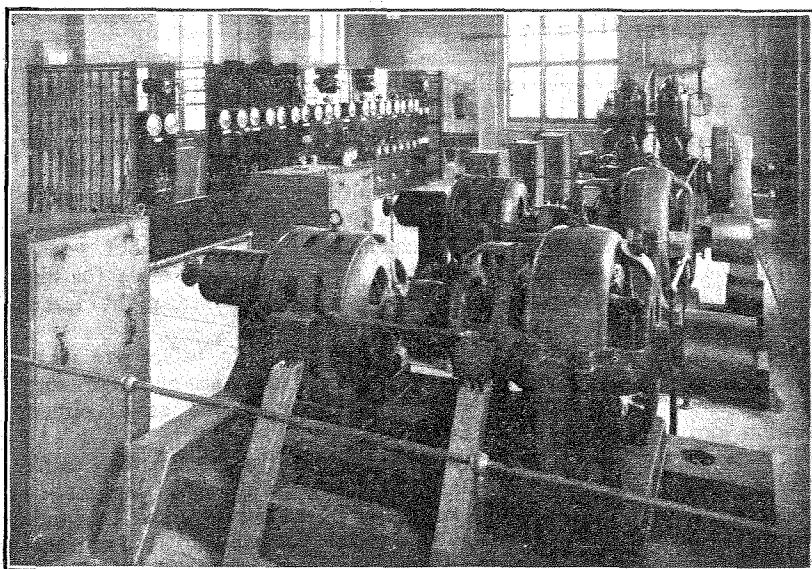

The power room at the Northolt station.

**Post Office Services.—**

range of communication. The cost of a station of this magnitude works out at between £400,000 and £500,000.

**Beam Stations.**

The Post Office entered into an agreement last summer with the Marconi Co. for the erection of a beam station, sending and receiving, in this country for communication with a similar station in Canada, and this agreement allows also for the provision of stations for communication with corresponding stations in South Africa, India, and Australia.

The station for the Canadian communication, which will only cost some £50,000, is to be able to communicate with Canada at a speed of 100 words a minute each way for a daily average of eighteen hours, the Post Office to pay the company 6½ per cent. of the gross receipts so long as any essential Marconi patents are being used. If, however, the working of the station should prove to be unsatisfactory, the company will receive no payment.

For the additional units the conditions are similar, except that the average daily hours of communication guaranteed are to be eleven hours for South Africa, twelve for India, and seven for Australia.

The sending and receiving sections of each station are to be able to work simultaneously, the operation being

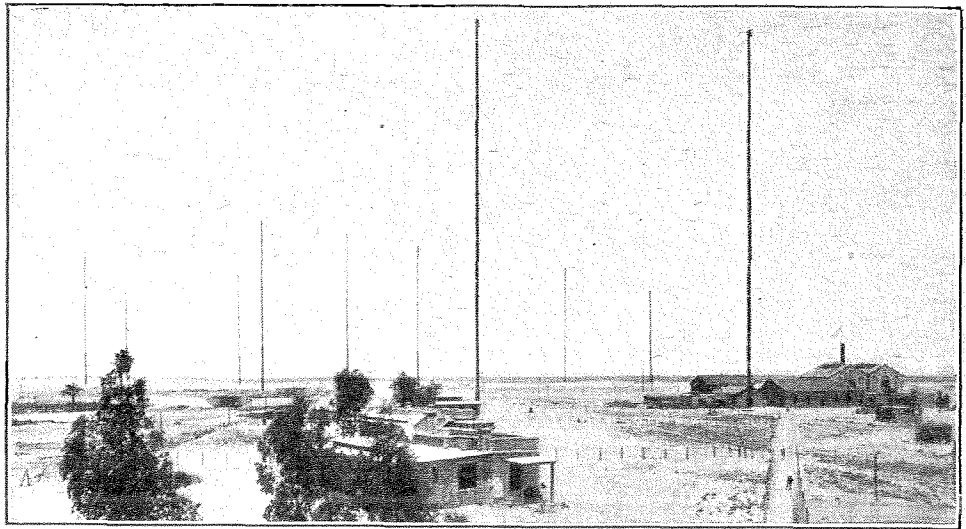

General view of Abu Zabal-Cairo wireless station.

carried out at the General Post Office in London, as in the case of other Post Office point-to-point stations.

The sending stations are each to have an input power of at least 20 kw., and the aerial system is to be designed so as to concentrate the emitted continuous waves within an angle of 30°.

The rates for the Canadian traffic are not to exceed existing rates, and the rates for the other traffic are not to exceed two-thirds of the cable rates.

This arrangement of directional beam stations, working in conjunction with the world-wide station at Rugby and with various other stations in the Empire, will form, it is hoped, a really efficient system of Imperial wireless communication.

**Lowestoft.**

British.—2NE, 2PP, 2SW, 2VO, 6JO, 5PU, 6XY, 6YM. Irish.—7AR.  
(0-v-0.) P. SAVAGE.

**Braintree, Essex.**

British.—2CC, 2LZ, 5MA, 6RM.  
French.—8FI, 8FQ, 8RDI, 8SM, 8UD.  
(40 metres and under.)  
D. WOODS (G2AXZ).

**Upper Edmonton, London, N.18.**

British.—2CU, 2QM, 5TZ, 6FG, 6ZX.  
(0-v-1.) J. O. J. HUDSON (G2AUP.)

**Chadwell Heath, Essex.**

French.—8AB, 8BF, 8BV, 8DKV, 8EM, 8FC, 8FT, 8GI, 8KT, 8LMT, 8MAR, 8RO, 8XH, 8XK. Belgian.—4AS, 4AV, K2, W2. Dutch.—0BA, 0GC, 0LL, 0NL, 0RE. Finnish.—1NA, 2NCA.  
(Between 60 and 120 metres.) (0-v-1.)  
H. F. SHEA, 2ANK.

**Harrow.**

Australian.—3BQ, 3BD, 2DS, 5BG.  
Iraq.—GHH1, M1, GHB. American.—5UK, 5RH, 5LV, 5CN, 5AIL, 5ALR, 5AJT, 5OX, 5SR.  
(2 valves.)  
F. C. and T. A. STUDLEY.

**Calls Heard.**  
Extracts from Readers' Logs.

**Massachusetts, U.S.A.**

British.—2SZ, 2JF, 6VP, 5NN, 2KF, 6RY, 2KW, 5LS, 2QZ, 2KZ, 6LJ, 5LF, 5QV, 2LZ, 5SZ, 2FU, 2NB, 5MO.  
French.—8AB, 8GO, 8HSG, 8AV, 8AP, 8EU, 8SSU, 8SM, 8BO, 8CZ, 8DP.  
Belgian.—4YZ, 4RS. Dutch.—0BA, 0RE, 0LL, 0NL. Danish.—7EC, 7ZM.  
Swedish.—SMZS, SMYA. Spanish.—EAR2.  
(0-v-2.) F. H. HANKINS, JR. (UICI).

**Stockton-on-Tees.**

Belgian.—4AA, 4AE, 4LOV, 4RS, 4ZZ. Dutch.—0RE, PB10, 2PZ.  
Swiss.—9BR. Swedish.—SMFN, SMWF, SMYY. Finnish.—FN, 5NQ. Rhineland.—1CF. Russian.—RDW.  
Italian.—1AM. Moroccan.—AIN.  
J. W. PALLISTER (G2NQ).

**Burnley, Lancs.**

American.—1AF, 1AJX, 1AL, 1ALL, 1ATJ, 1AWE, 1BBE, 1BEP, 1BES, 1BGQ, 1BKQ, 1CAB, 1CAK, 1CME, 1CMP, 1CTS, 1EZ, 1MC, 1PD, 1PL, 1RD, 1XMI, 1XZ, 1YB, 2AF, 2AG, 2BGI, 2BM, 2CBG, 2CEE, 2CEI, 2CJX, 2CLA, 2CPO, 2CQA, 2CY, 2DN, 2GK, 2KX, 2MC, 2MU, 2RK, 2WL, 2YB, 3AB, 3ADP, 3ADQ, 3AJD, 3BLP, 3CF, 3CM, 3MF, 3NB, 3TJ, 4GW, 4IO, 4JR, 8AY, 8DNF, 8WA, 9CV, 9CVO, NKF, WGH, WJR, SA, WJS. Canadian.—9BF.  
(0-v-0 Reinartz.) W. H. DYSON.

**Glasgow.**

British.—5PU, 2NB, 6KK, 5MA, 2FM, 2DX, 6RM, 5LB, 6UZ, 2CC, 5PZ, 2QM, 5TZ. American.—1AAP, 1AAY, 1AJO, 1AL, 1ALL, 1AQM, 1BES, 1BPZ, 1ER, 1FN, 1JS, 1NO, 1RR, 1SK, 1SW, 1YDA, 1ZA, 1ZS, 2AGW, 2BW, 2BLM, 2BVH, 2CPD, 2CVJ, 2JUM, 2NCJ, 2QD, 2TAR, 3AB, 3OQ, 3QV, 4SQ, 8XMY, 9CKU, 9EDV, 9ELB. French.—8CG, 8CPP, 8GB, 8JRK, 8UL, 8UT, 8VAA, 8YOR. Dutch.—0BA, 0BG, 0GC, 0LL, 0RE, 0SA, PCL. Italian.—1NO, 1RO, 2CO. Belgian.—4LOV.  
(0-v-1.) FRANCIS G. S. MELVILLE.

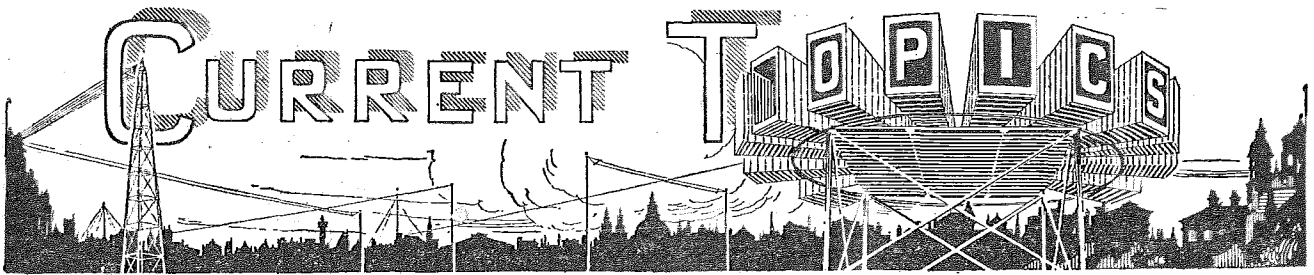

## Events of the Week in Brief Review.

### LOUD-SPEAKERS IN CHURCH.

Following upon the installation of loud-speakers in Notre Dame, the Church of St. Sulpice, Montmartre, Paris, has been similarly equipped.

o o o o

### DUTCH WIRELESS EXPANSION.

Dutch wireless exports during the past year show an increase of fifty per cent. Consignments of valves form a large proportion of the goods exported.

o o o o

### IRISH FREE STATE BROADCASTING.

The broadcasting policy of the Irish Free State has been outlined in the Dail by Mr. Walsh, Postmaster-General. It was stated that the Minister of Finance had agreed that broadcasting should be run by the State, with the main station in Dublin and a subsidiary one in Cork.

o o o o

### WIRELESS IN THE HOSPITALS.

The *Daily News* is to be congratulated on inaugurating a "Wireless in the Wards" Fund, by means of which it is hoped that hospitals throughout the country will soon be equipped with broadcast receivers. The Fund is organised under the presidency of H.R.H. Princess Louise Duchess of Argyll, and generous subscriptions have already been forwarded by the King and Queen and Queen Alexandra.

o o o o

### SIGNALS FROM MR. SCHNELL.

Another British listener to report signals from NRRL, the American Navy's experimental short wave station, is Mr. E. Manley, of Wimbledon Park, who picked up strong signals on May 24th with a two-valve set (0-v-1). NRRL, who stated he was working on the second harmonic of his aerial, transmitted with a rough A.C. note, on a wavelength of 40 metres.

o o o o

### R.S.G.B. TALKS.

The talks from the London Station by the Radio Society of Great Britain are now given twice a month instead of weekly, as previously, and take place at 6.40 p.m. on the first Monday and 7.40 p.m. on the following Saturday week. Fifteen minutes are now allotted for each talk, and in view of this extended time it is hoped to increase the interest of this feature very considerably. On Saturday, June 13th, Dr. W. H. Eccles, F.R.S., will speak from 2LO on behalf of the Society.

A 22

### NEW TRANSMITTERS' SOCIETY.

Several amateur transmitters are endeavouring to form a DX Society in West London. Membership is open to all experimenters who are genuinely interested in wavelengths below 200 metres and who held experimental licences prior to the advent of broadcasting. The new society will support the R.S.G.B., and is in no way intended as a rival organisation.

Full particulars may be obtained from the organising secretary, Mr. F. H. Cooke, 183, Carlton Vale, N.W.6.

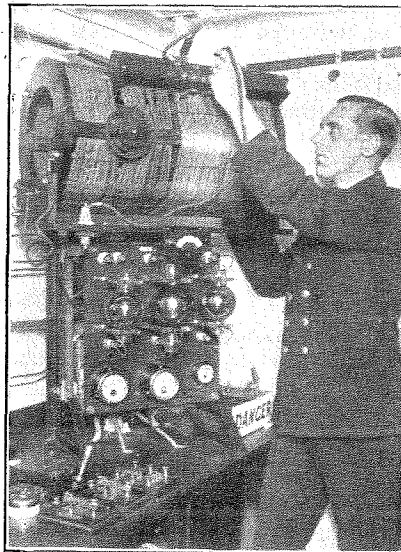

**A WIRELESS COMPASS.** The one and half kilowatt transmitter and wireless compass on board the s.s. "Homeric." It will be remembered that the "Homeric" located the ill-fated "Raifuku Maru" by wireless compass, but was unable to effect a rescue.

### H.F. FOR SELECTIVITY.

In his broadcast talk on behalf of the R.S.G.B. on Monday, June 1st, Mr. H. Andrews, B.Sc., remarked upon the curious fact that quite 75 per cent. of valve broadcast receivers use direct-coupled circuits, which are very unselective. He urged his listeners to seek greater selectivity by using (a) a loose-coupled circuit, (b) high-frequency valves, or (c) tuned traps, filters, etc. He considered that the average H.F. valve does more towards sharpening the tuning than in actual amplification.

### FRENCH WIRELESS TRADE COMBINE.

Wireless manufacturers, and wholesale and retail traders in France, have formed themselves into a union for mutual protection under the name "Union Radiophonique de France."

o o o o

### GOOD TRANSMISSION WORK.

To transmit over a distance of 1,100 miles with a power input of only 8 watts can be reckoned as no mean achievement. It was carried out on May 17th by Mr. L. Bland Flagg (G2GO), of Bayswater, in working on 90 metres with Mr. K. Secretan (G6YM), when the latter was experimenting on board ship 1,100 miles out at sea. Mr. Bland Flagg's equipment consisted of a loose-coupled reverse feed back circuit delivering an antenna current of .25 ampere.

On May 23rd Mr. Bland Flagg was in communication with Finnish 2NM, who stated that he was transmitting with one receiving valve and a power of three watts!

o o o o

### BROADCASTING FEES BY INSTALMENTS.

An interesting if rather elaborate system by which listeners' fees are paid by instalments has been introduced in the Union of South Africa, says *The Times*. By an arrangement between the postal and the broadcasting authorities, listeners may now pay a first instalment of 15s. and the remainder in three monthly instalments of 10s. each. Of the whole sum, 5s. goes to the Government and £2 to the Cape Peninsula Broadcasting Association. This concession has been found practically essential with so high a fee as £2 5s.

o o o o

### LOUD-SPEAKERS ON THE RAILWAY.

Experiments with loud-speakers have been continued at St. Pancras Railway Station with complete success. An interesting outcome of these tests is the discovery that a man's voice is more suitable than a woman's, being clearer and more penetrating.

o o o o

### SUPERSONIC RECEPTION.

An informal meeting of the Radio Society of Great Britain will be held this evening (Wednesday) at 6 o'clock, at the Institution of Electrical Engineers, Savoy Place, W.C.2. Mr. W. K. Alford will open a discussion upon "The Application

of the Supersonic Method of Reception to Ultra-short Wavelengths."

Informal meetings of the Society are open to members of affiliated societies, who are cordially invited to attend. The general public are admitted by free ticket, obtainable from the offices of the Society, 53, Victoria Street, London, S.W.1.

o o o o

**23-METRE TESTS.**

On and after July 1st tests are to take place from an experimental station in Cornwall on wavelengths between 10 and 55 metres (transmission on 23m. and 45m.). Regular daily schedules over an extended period can be arranged, the tests to take place at any period during the 24 hours. Communications should be addressed to Mr. R. H. P. Collings, 257, Croxted Road, London, S.E.21.

o o o o

**AMPLIFIERS AT THE OPERATING TABLE.**

Broadcast amplifying equipment will perform an important part in the new nurses' home and operating theatre to be opened to-day (Wednesday) at the London Temperance Hospital by Prince Arthur of Connaught.

The operating theatre will be separated from the students' room by a glass screen, through which it will be possible to observe operations in progress without incommoding the surgeons at their work. By means of amplifying equipment, however, it will be possible to describe operations step by step to those who have come to study. This system has already been used with success in Paris.

o o o o

**CANADA MARCONI CHANGES.**

Mr. Charles G. Greenshields has resigned the presidency of the board of directors of the Marconi Wireless Tele-

graph Company of Canada, and Mr. G. M. Bosworth has resigned his directorate. Dr. Milton Hersey becomes the new president, and Mr. H. M. Short general manager and managing director.

o o o o

**JOHANNESBURG HEARD IN EAST ANGLIA.**

An aged mother, Mrs. Marsh, of Felix stowe, was recently enabled to hear her son, the Rev. W. L. Marsh, speaking from the Johannesburg broadcasting station. In spite of the obvious difficulties of attempting to pick up such a distant station, Mr. Barbrook, secretary of the Ipswich and District Radio Society, installed a three-valve set in Mrs. Marsh's house. By careful tuning Johannesburg was picked up, with the result that Mrs. Marsh was able to identify her son's voice, although atmospheric conditions prevented the hearing of complete sentences.

o o o o

**WIRELESS IN THE FAR NORTH.**

It has been decided to establish the most northerly main station of the North-West Territories and Yukon Wireless System at Aklavik in the Mackenzie river delta.

The Royal Canadian Corps of Signals, in co-operation with the North-West Territories and Yukon Branch of the Department of the Interior, will establish the station this summer.

o o o o

**REPORTS, PLEASE.**

Mr. Thomas Geeson (2SO), who has changed his address to Gainsborough House, Congleton Road, Macclesfield, announces that he transmits regularly every week-end and would be glad to receive reports.

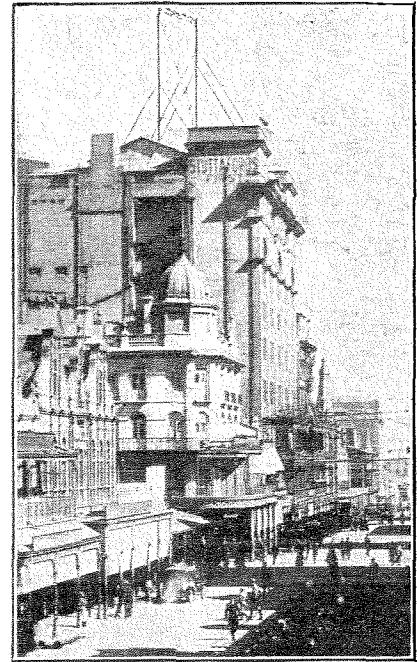

"J.B." FROM WITHOUT. The Johannesburg station and aerial photographed from the street.

**BROADCASTING 4,000 PERFORMERS.**

Arrangements have been made to broadcast a section of the 16th Annual Concert of the National Union of School Orchestras, which will be held in the centre transept of the Crystal Palace, on Saturday evening, June 13th. 4,000 performers will participate.

This concert, which will be composed entirely of massed orchestras selected from schools in London and the Home Counties, will be assisted by the band of H.M. Scots Guards.

o o o o

**CALL SIGN CHANGES.**

Since the publication of the last *Wireless World Directory of Experimental Transmitting Stations* the call sign 2OZ has been assigned to Mr. John W. Norton, "Konrad," Salisbury Road, Exmouth, Devon. The call sign 2QB has been allocated to Mr. R. W. Bailey, "Broadeaves," Fairfield Road, Widnes, Lancs. 2QB transmits on 190 metres.

o o o o

**WHO IS KL4 ?**

Several readers report the reception of signals from a German amateur with the above call sign and would be glad to learn of his identity.

**BOOK RECEIVED.**

*A Text-Book of Wireless Telegraphy and Telephony.* By W. Greenwood, B.Sc. (Eng.), A.M.I.E.E., A.C.G.I. (London: W. B. Clive, University Tutorial Press, Ltd., High Street, New Oxford Street, W.C.). 265 pp. 201 figures. Price 5s. 6d. net.

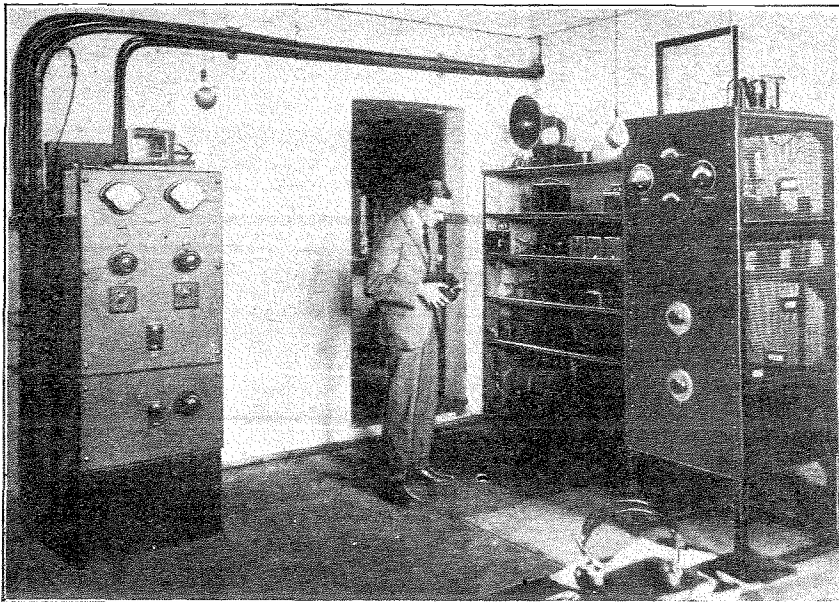

BROADCASTING IN SOUTH AFRICA. A view of the transmitting room of the Johannesburg broadcasting station. Mr. J. N. Ray, assistant station engineer, is seen using a wavemeter.

# CONNECTING UP AN INTERVALVE TRANSFORMER.

The Effect of the Method of Connection on the Performance of L.F. Amplifiers.

By P. W. WILLANS, M.A.

**M**OST intervalve transformers used for the purpose of low-frequency amplification are supplied with the terminals of the primary and secondary windings designated in each case as "I" and "O." These letters stand for "inner" and "outer" respectively, and denote that the terminal labelled "inner" is connected to the innermost point of either primary or secondary winding, and the terminal labelled "outer" to the outermost point.

### Direction of Windings.

The importance of these designations has actually very little reference, if any, to the fact that one terminal is connected to the winding near to the core, and the other terminal to a part more remote. Their real significance is bound up with the fact that the two windings, primary and secondary, are, within the writer's experience, *invariably* wound in the same direction (clockwise or anticlockwise) from inner to outer.

The effect is that, if we connect the positive and negative terminals of a battery respectively to the inner and outer terminals of the primary winding, the core is magnetised in exactly the same sense as if we had connected the battery to the secondary winding in the same way. In other words, a current flowing through either winding from inner to outer has a magnetic effect of the same kind.

If we consider what happens when a low-frequency transformer is connected in a valve circuit, it is apparent that only one winding, namely, the primary, has a direct

current flowing in it. On the other hand, both windings will have "speech" currents flowing in them due to the varying voltage applied to the grid of the valve in whose anode circuit the primary winding is connected, the alternating current in this circuit exciting a current in the secondary winding owing to the fact that the latter has self capacity, *i.e.*, behaves as though there were a condenser across its terminals to store up electric charge.

Let us consider now what this can mean in relation to the various circuit connections of the transformer. It is well known that the approximate effect of using a transformer in a valve circuit is to multiply the alternating voltage applied across the primary windings by the ratio of the number of secondary turns to those in the primary. Thus, if we are using a transformer of ratio 4/1, and we have an alternating voltage of a maximum value of 1 volt on the primary winding, there will be an alternating volt-

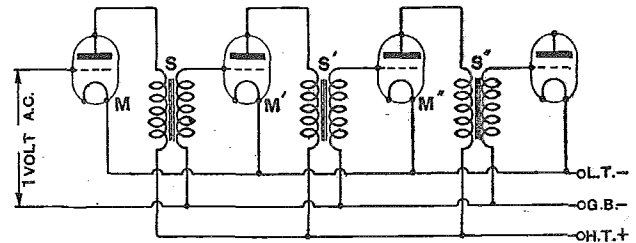

Fig. 2.—A three-stage low-frequency amplifier.

age of 4 volts across the secondary. This is not always strictly correct, as at very high frequencies a phenomenon known as magnetic leakage makes itself manifest in conjunction with the self capacity of the windings, but at any rate, for moderate frequencies we may take it as substantially true.

What then is the effect of altering the transformer connections? The answer is that until these are definitely settled it is not established whether the voltage across the primary winding will be in the same *sense* as that across the secondary; in other words, whether at the moment when the plate is at a positive voltage, the grid of the next valve will be at a positive or a negative voltage.

### "Positive" and "Negative" Connections.

From the construction of audio frequency transformers it is apparent that if the O.P. terminal is connected to plate, the O.S. terminal to grid, and the remaining terminals to H.T. battery and filament, the voltages on the plate of the one valve and the grid of the next will have the same sense; further, if the I.P. terminal is connected to plate and the I.S. terminal to grid, the same effect will be obtained. On the other hand, if the plate and grid are connected in either of two ways, one to the

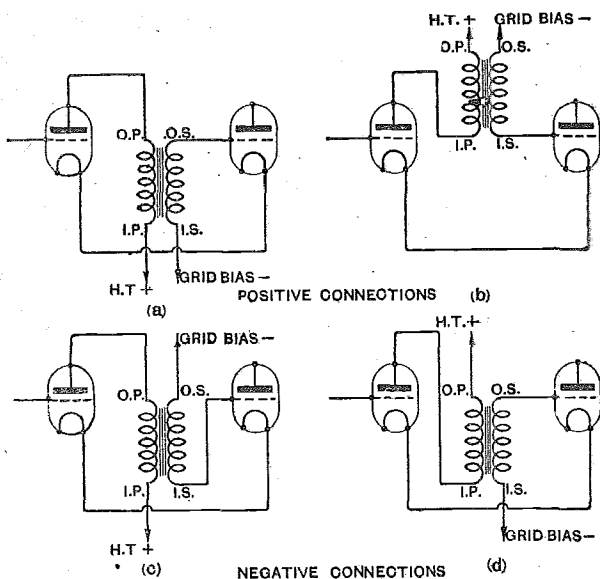

Fig. 1.—Methods of connecting low-frequency intervalve transformers.



**Connecting up an Intervalve Transformer.—**

outer terminal of one winding and the other to the inner terminal of the other winding, then at the same instant the voltages of the plate and grid will be opposite in sign.

We may denote the first two arrangements as "positive" connections, and the second two as "negative." These are illustrated in Figs. 1 (a), 1 (b), 1 (c), and 1 (d).

Experiment goes to show, in the first place, that there is nothing to choose between the two positive connections in the average low-frequency transformer nor between the two negative connections, except in some very unusual circuits where a reversal of both windings has on occasion reduced the tendency to instability. On the other hand, both from the theoretical and practical standpoints, there is a very great deal of difference between the positive and negative connection.

Referring to Fig. 2, which is a circuit diagram of a three-stage audio frequency amplifier, let us assume that an alternating voltage of unity value is applied to the grid of the first valve, and that at the moment of observation, the grid of the first valve is positive in relation to its average value. In accordance with a well-known theory, the plate of the valve will be at the same instant negative, and if we consider the particular frequency for which the transformer is resonant, the voltage on the plate will be approximately the grid voltage multiplied by the magnification factor of the valve, *i.e.*, denoting this latter magnitude by "*m*" it will be  $-m$  volts.

It will depend upon whether the transformer is connected up positively or negatively what the sense of the voltage of the next grid will be. We may denote the ratio of the transformer by the letter "*s*," and consider "*s*" to be positive if the transformer is positively connected and negative if the transformer is negatively connected.

With this assumption the voltage on the second grid is  $-ms$ , and is thus opposite in sign to the first grid voltage if the transformer is positively connected, and the same in sign if the connection is negative.

Similarly, if the magnification factor of the second valve is  $m^1$ , and the transformer ratio of the second transformer is  $s^1$ , the voltage on the third grid will be  $-m^1s^1$  times the voltage on the first grid. In other words, its value will be  $mm^1ss^1$  volts.

Thus if *s* and  $s^1$  are both positive or both negative, the third grid and the first will have the same sign at the same moment; if, on the other hand, one is positive and the other is negative, the grids will have opposite signs.

If  $m^{11}$  and  $s^{11}$  are the corresponding values for the third valve and its transformer, the voltage on the fourth grid will be  $mm^1m^{11}s^{11}$ , and results of this will hold good, not exactly but qualitatively, for any number of stages at one particular frequency.

**Effect of Connections on Performance.**

The effect of these connections on the performance of the amplifier is not easy to trace, but it may be summarised as follows:—First, there is the effect on the performance of the transformer itself when its windings are either positively or negatively connected; secondly, there is the probable effect of either one connection or the other on the cascade amplifier as a whole.

As regards transformers in a single stage, the writer

has made some measurements on a number of these, and in every case it was found that a transformer with a negative connection behaved as though it had more capacity than when a positive connection was employed. This effect was observed as a drop in the amplification of frequencies above 2,000 or 3,000 cycles per second, and amounted to an increase, in one particular case, of about 20 per cent. of the total capacity of the transformer and its circuit connections (including the grid filament capacity of the valve to which the secondary was connected). This is a disadvantage, excepting only in cases where an addition of a certain amount of capacity to the transformer is not of importance, as, for example, a reflex circuit when an external condenser is connected across the secondary winding.

Under the second heading, namely, the effect on a multi-stage amplifier, there are more important questions to be considered. It is a matter of common knowledge that such amplifiers have a tendency to "howl" when many stages are connected in cascade, and that it is often possible to eliminate this effect by reversing the connections of one or more of the transformers. It is not by any means established, however, that either the positive or the negative connection on the amplifier is most generally advantageous.

Although it is impossible to give a full account of the causes of "howling" in a low-frequency amplifier, it may broadly be stated that there are two main sources of trouble; the first is the effect of capacity coupling between the transformer in the plate circuit of the valve and the transformer connected in the grid circuit of the same valve, this being due to the capacity between the grid and the anode of the valve. Secondly, there may be instability owing to external electro-magnetic or electrostatic reaction.

All experiments on the subject go to show that undoubtedly, even in an amplifier working on low frequencies, the valve capacities play a very great part in giving rise to instability.

Considering this matter from the theoretical point of view, it is fairly clear that the sense of the connections of a transformer will have no effect upon the voltage carried back through the capacity of the valves from output to input, excepting in so far as the properties of each transformer are altered as regards self capacity. The reason for this is that the change over from one sense to the other in the case of any transformer in a cascade amplifier will admittedly reverse the sense of the voltage on the output side, but will also reverse the sense of the small fraction of the latter which is carried back to the input. Thus, for example, if we have an amplifier which gives a thousand-fold amplification and apply to the grid of the first valve an alternating e.m.f. of one-hundredth of a volt, we will obtain on the output side an e.m.f. of +10 volts, say, when the transformers are connected up in a certain manner. Owing to the effect of valve capacities a very small fraction of this will be passed back through the chain of transformers and valves, say a millionth part or  $10^{-5}$  volts, and this voltage may be in any phase relationship to the voltage applied to the grid.

Now, if we reverse the sense of one transformer connection, the voltage on the last valve will be  $-10$  volts, the sign being changed, but the retroactive voltage will

**Connecting up an Intervalve Transformer.—**

also be exactly changed in sign in relation to the output voltage, and will therefore be  $10^{-5}$  volts, and in the same phase relationship to the input voltage as before.

**Stability of L.F. Amplifiers.**

We may say, generally, therefore, that a tendency to oscillate which is due to valve capacity coupling is not modified by a change in the sign of the transformer connections. Cases of this effect are frequently encountered, the only change being in the pitch of the note on which howling is taking place, this being readily attributable to the changed self capacity of the reversed transformer.

Passing on to external stray couplings it is at once evident that the reversal of one transformer will reverse the sense of the retroactive voltage, since the latter does not "pass through" the transformer, but goes straight back to the input of the amplifier.

A stray coupling of this kind may be either electromagnetic or electrostatic. Both effects have been observed after two stages of amplification, but with only a single stage the predominating retroactive effect is that through the valve. In most cases the trouble is electrostatic, as the effect persists if both windings of any transformer are reversed simultaneously. If, however, as sometimes happens, an improvement results in carrying out such a change, it is a proof that the direction of the magnetic field of the transformer was the ruling consideration.

It may be remarked in passing that a low-frequency transformer, when in circuit, must invariably have an external electromagnetic field, however well the iron circuit be constructed, because the changes of magnetic flux in the iron are so small that the permeability of the core

is less than one-tenth of its full value. This means that a ten times larger percentage of magnetic flux than the normal will pass through the surrounding air and possibly link itself with the input circuit to the amplifier. Under these conditions the presence of a small air gap in the iron circuit will make little difference, whereas had the changes of magnetic flux been greater, as in an A.C. power transformer, an air gap would have had a marked effect.

As regards the positive or negative connection, the writer's experience is that in a practical amplifier it is impossible to say which is the better of the two, as so much depends on the individual instrument. There is a general tendency in the technical Press, and also among manufacturers, to specify the negative connection as the "orthodox" one. The writer's belief is that either may have to be used according to circumstances, but if either adequate spacing or screening between stages is employed in the amplifier, then it should be possible to use the positive connection, which gets the best out of the transformer and has no harmful effect as regards valve capacity coupling.

Many other factors are contributory to instability in amplifiers, but these cannot be adequately dealt with here. As far as external couplings are concerned, earthing the core of the transformer may on occasions have a good effect, but it most decidedly increases the self-capacity of the transformer, and for that reason, in the writer's opinion, should be avoided where possible. The best form of screening is an earthed copper box totally enclosing the transformer and insulated from it, the spacing between the box and the transformer being nowhere less than half an inch.

THE "Year Book" for 1925, which is now published by Messrs. Iliffe and Sons Ltd., retains the well-known features which have distinguished it since its inception in 1913. Following the practice adopted last year, the list of ship stations and their respective call-signs is omitted, as it was found that this section added enormously to the bulk of the book, and the changes in call-signs and other particulars relating to these stations were so frequent and extensive that, by the time the list was printed, much of the data had become obsolescent. The particulars of land stations are more stable, and the list, comprising over 1,800 stations, has been carefully revised and brought up to date. In addition to giving the wavelengths of each station, the nature of any special transmission (weather reports, time signals, press messages, etc.) is indicated against their respective wavelengths, adding greatly to the value of the tabular information.

The scientific signal section, which has been considerably enlarged and revised by Mr. W. G. W. Mitchell, comprises full information concerning meteorological, hydrographic, navigational, and time signals, besides general transmissions of interest to navigators, astronomers, and those engaged in scientific research. It is understood that the preparation of this section somewhat delayed the

**YEAR BOOK OF  
WIRELESS TELEGRAPHY  
AND TELEPHONY, 1925.**

publication of the book, as, after the greater part had been set up in print, extensive alterations to the time and meteorological signals were made by the authorities concerned, and it was thought better to bring the information up to date, even if it retarded the date of publication, than to

print matter which had been superseded.

A brief description of the principal valve patents issued during 1924, and an index of British wireless patents during the same period, form again an important section of the book, and the comprehensive vocabulary of technical terms in English, French, German, Spanish, and Italian will be found most useful.

Special articles on technical subjects are contributed by Dr. A. N. Goldsmith, Capt. H. J. Round, Mr. T. L. Eckersley, and Capt. A. G. D. West. The fifty-six maps, which give the positions and nature of transmissions of all known land stations in the world, have been carefully revised and brought up to date, and, altogether, the high standard and completeness which has distinguished this publication in the past is fully maintained in the present number.

"THE YEAR BOOK OF WIRELESS TELEGRAPHY AND TELEPHONY," 894 pp., with 56 pages of maps. Published by Iliffe & Sons Ltd., price 15s.

# Broadcast Brevities

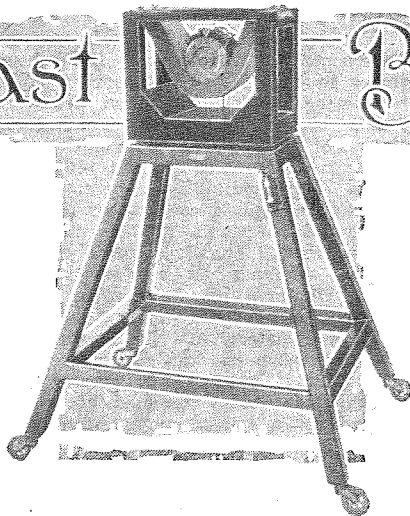

## SAVOY HILL

### Something "On Account."

The erection of a new high-power station in Berlin, just announced, will afford some satisfaction to listeners along the East Coast of Britain, who are at present poorly served. A measure to counter this will be achieved when Daventry comes into service in August, but the question will then arise whether another station should be erected, working on a wavelength of 500 to 800 metres. At about the same time it is probable that steps will have to be taken to increase the power of Manchester station, so that the service for listeners on the East and North is likely to be immeasurably improved before next winter. Development here must be in the direction of giving variety by the introduction of alternative programmes so as to bring in larger crystal areas.

o o o o

### Schools for Announcers.

Is there any regulation pronunciation of the English language? The question will be dealt with and an endeavour made to settle satisfactorily the requirements of broadcast speech if the suggestion should materialise to form a kind of school for broadcast announcers. In New York a Speech Clinic, which was established four years ago for the correction of speech defects, has done some interesting work, and recently conducted a test to discover the exact technique of the ideal announcer. A similar scheme is being prepared in this country.

o o o o

### Experience Teaches.

It is now generally recognised that the erection of main broadcasting stations within big cities is a thing of the past, and the unfortunate experience connected with the Oxford Street station will not be repeated. Manchester was an early example of radiation difficulties. The aerial is surrounded on all sides by big buildings, three sides steel-framed, with a brick building on the fourth side. On the sides of the steel-framed buildings there was more radiation than on the side of the brick building, and considerable experiment had to be made with the alteration of the earth screens to correct the fault.

o o o o

### Engineers' Problems.

The engineers tell me that they are studying in addition to the question of suitable sites outside big towns, the problem of stations which suffer from

## TOPICALITIES.

peculiarities of geological surroundings. Cardiff is a case in point, where the mineral character of the ground does undoubtedly affect the range of transmission. Any alteration, either in the power or the situation of the Welsh station, will have to be considered first from the national aspect and next from the view of the crystal area, so as to bring in the Rhondda Valley. An increase in power would bring Bristol within a double programme area, and would provide a better service for the south-western counties of England.

o o o o

### Radio Drama.

In the search for originality, the B.B.C., I am told, is exploring the possibilities of introducing natural noises into a new type of radio play. The idea is to avoid leaving everything to the imagination of the listener, and instead to transport him in mind to the scene of the incidents described by speech or song. Country plays will have a background of country noises; town plays, of town noises; and plays dealing with life in the Army and Navy will have their natural settings. During the summer it is hoped to produce several plays connected with open-air life, with the appropriate atmosphere.

o o o o

### Where are the Radio Societies?

The spasm of oscillation in Lancashire, where as many as thirty-two reports in one month have been received by the Manchester station, has brought the interesting suggestion that those radio societies which are not moribund should seek the help of their local Press, which, I understand, would be readily forthcoming, to put down the nuisance. It has been found that where the help of the newspapers has been enlisted in any particular area, the trouble has been considerably checked. Radio societies might also make it the opportunity for prevailing upon local listeners to become members, as a good deal of useful work has been done by the spread of information.

o o o o

### S.O.S.

Several listeners in different parts of the country have recently picked up an S.O.S. One listener has enquired of the authorities what should be done in these circumstances. It is obviously his duty, if the signal has not been picked up by anybody else, to report it to the nearest official, whether Post Office or Police.

**FUTURE FEATURES.**

**Sunday, June 14th.**

LONDON.—3.30 p.m., Russian Programme.

LONDON.—9 p.m., Gems from Oratorio.

BOURNEMOUTH.—9 p.m., Oratorio, "The Creation" (Haydn).

GLASGOW.—9 p.m., "Stabat Mater" (Rossini).

**Monday, June 15th.**

LONDON.—8 p.m., Gershwyn. A Concert of Syncopated Symphonic Music at his Reception.

ALL STATIONS.—10.30 p.m., Act III. of the Opera, "Lucia di Lammermoor" (Donizetti).

**Tuesday, June 16th.**

ALL STATIONS.—9.30 and 10.40 p.m.; The Aldershot Command Searchlight Tattoo.

**Wednesday, June 17th.**

LONDON.—8 p.m., Gounod's Anniversary. Symphony Concert.

BOURNEMOUTH.—8 p.m., "Four Cameos."

MANCHESTER.—8 p.m., The 2ZY Light Music Octet.

GLASGOW.—8 p.m., Vocal and Orchestral Programme.

BELFAST.—8 p.m., Symphony Concert.

**Thursday, June 18th.**

LONDON.—8 p.m., Star Ballad Concert. S.B. to all Stations except Aberdeen.

**Friday, June 19th.**

LONDON.—8 p.m., British Regimental Marches.

CARDIFF.—10.30 p.m., Chopin Recital.

GLASGOW.—8 p.m., "The Three Musketeers" (Episode I.).

ABERDEEN.—8 p.m., Popular Evening with a Play.

**Saturday, June 20th.**

BOURNEMOUTH.—8 p.m., Band of Royal Tank Corps.

GLASGOW AND 5XX.—8 p.m., Musical Comedy Programme.

**A Moral Obligation.**

There is a serious moral obligation attaching to this course, and if the listener is not an adept at Morse, he might not receive the reply of the shore station, or, again, it might take the shore station some time to make arrangements with the lifeboats or tugs, or whatever may be required, and then to answer the signal. It seems that the best plan would be for Government Departments to come to an agreed arrangement and then to get the B.B.C. to broadcast directions as to what course should be pursued by listeners who, it is believed, would be only too ready to help if they thought that their efforts would be welcomed.

o o o o

**The Mystery Pianist.**

One night recently one of the most brilliant of Continental pianists paid an unexpected visit to 2LO to inspect the studio. The question of acoustics cropped up, and the pianist sat down at the piano and played one or two airs. As the ordinary programme was some ten minutes in advance of schedule time, he was able to give listeners a rare treat. The mystery surrounding his identity cannot be explained for very special reasons. Listeners will be glad to know, however, that arrangements have been made to engage his services in the orthodox way for broadcasting later on. He appeared in London some years ago, but his emergency performance of the other evening was his first broadcast.

**French Interference.**

The trouble of French interference on Bournemouth wavelength has been traced to one of its chief sources. The interfering station has been definitely found to be 8AJ, the experimental station of Radio-Paris. The station was working Coblenz, calling an individual named Raymond. The operator was working in English, and on one occasion was heard to repeat English sentences twelve times. The supposition is that he was conducting experiments with echo. He gave his wavelength as 360 metres on a night when he was measured as on 372 metres, and his power as 3 kilowatts when he was obviously using much greater power. The greater part of the transmission consisted of gramophone records, but on one night recently he had a number of ladies in the studio to whom he referred as "the best artistes in Paris."

o o o o

**South Coast D.F. Listeners to the Rescue.**

The thanks of the B.B.C. and of listeners generally along the South Coast are due to listeners at Brighton and Eastbourne for D.F. bearings, and to several others at Bognor, Hastings, and elsewhere who gave their assistance in tracking down the offending station. It is hoped that the representations which have been made will have a beneficial effect.

o o o o

**Work for Geneva.**

The duty of dealing with offenders of this type will be undertaken at a future

date by the International Bureau at Geneva. Laws to which the participating nations must be called upon to subscribe will be framed shortly by Mr. Burrows, and while certain nationalities profess themselves unable at present to deal with delinquents, it is hoped that the promise of drastic penalties will have the desired effect in checking the trouble which thousands of British listeners have recently experienced.

o o o o

**Popularising Good Music.**

Is Bach dull? Mr. Edward Isaacs intends to prove the contrary at Manchester on Friday, June 19th, when he is giving a pianoforte recital with explanatory remarks from the lighter music of J. S. Bach, showing that a composer whom many appear to consider as dull and stilted has produced works of unusual geniality and lightness. Mr. Isaacs is very interested in wireless as a means of popularising good music. He has done a great deal himself for the musical education of Manchester, being the founder of the Edward Isaacs International Chamber Concerts, which have been responsible for bringing to Manchester such famous instrumentalists as the Lener Quartet, the Copenhagen Quartet, and the Kapelle Quartet.

o o o o

**A Busy Musician.**

Moreover he is the director of the Tuesday Mid-day Society's Concerts, which are such a popular feature of Manchester's musical life, and which, for the past few months have been relayed, and broadcast from the Manchester Station. Mr. Isaacs is also a very well-known solo pianist.

o o o o

**Unfruitful Wireless.**

Wireless has had to take the blame for a good many of the world's misfortunes; but read the following from a listener:—"There is a pear tree on the lawn of my garden to which is attached the pole of the aerial. This tree has borne plentiful fruit every year for the last forty years, but last year it only had about half-a-dozen pears on it, and this year has no sign of blossom, though in full leaf. Can you tell me if the absence of blossom is caused by the aerial being attached to the tree, and is it likely to cause destruction to it?"

o o o o

**The Power of Thought.**

A broadcasting experiment to determine the power of collective thought has been proposed by a certain American society for consideration by the International Broadcasting Bureau at Geneva. The idea propounded is that, at a prearranged moment, listeners to the principal broadcasting stations in the world should concentrate upon a single thought. Presuming that some fifty million listeners would take part, the American society wonders what would happen.



**THE QUEST OF THE NIGHTINGALE.** Engineers of the B.B.C. testing the relay apparatus for broadcasting the elusive notes of the nightingale at Miss Beatrice Harrison's home in Surrey.

# RECEIVER

## A Two-valve Set for

By F. W. DANZELMAN.

# FOR KDKA.

## Short-wave Work.

**A**LTHOUGH the reception of American broadcasting has become an achievement within the reach of everyone, it is by no means a common occurrence judging by the scarcity of "oscillators" in my neighbourhood. With the station KDKA on 68 metres this absence of co-enthusiasts is even more noticeable. The writer intends to risk a sudden crop of searchers by contributing a further opportunity to those who have not yet been tempted to listen to the really interesting programmes broadcast from East Pittsburg, Pa., U.S.A.

Any existing set constructed for a straight circuit can be adapted in a few minutes to the circuit shown in Fig. 1, merely by the addition of the micro-condenser N, without in any way detracting from the utility of the set for other work.

A two-valve set was chosen for the purpose, although good results can be obtained on one valve. This was done for two reasons: the majority of valve users possess two-valve sets, and the addition of one L.F. valve will give fairly certain results under any weather conditions.

### Construction.

For those who desire to construct a set similar to that shown in the photograph, the back view is shown with the wiring connections in Fig. 2. It will be noted that the layout is arranged to allow of short connections where

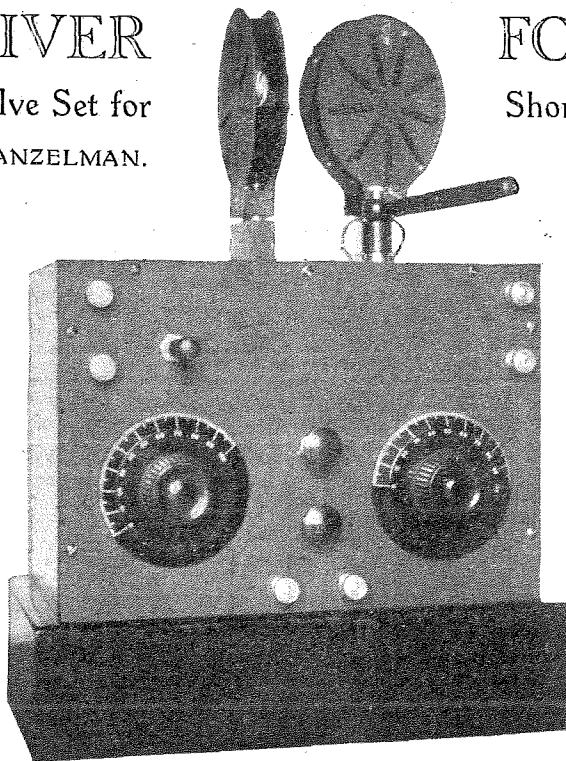

these are most useful, as well as giving a neat and symmetrical appearance. The front panel was made from a piece of dry 3/8 in. mahogany, and provided the set is kept in a dry room this method effects a considerable saving in cost without loss of efficiency. A refinement might be made by insulating the aerial terminal and the micro-condenser by means of ebonite bushes.

Flexible leads terminating in wander plugs are provided for high tension and grid volts; the two front terminals at the bottom are L.T. + on the right and a common negative and grid volts + on the left (front view). The two on the left at the top are aerial and earth respectively; and the two on the right-hand side are for tele-

phones or loud-speaker.

The set was wired with No. 18 tinned copper wire *without* Sistoflex sleeving, and resin flux was used for soldering, as the common "easy" fluxes leave patches of grease, which are a prolific source of leakage.

### Choice of Coils.

Owing to the high frequencies in use at this wavelength it is extremely necessary to use low-loss coils. Gambrell Efficiency Inductances were used for this reason, as they have a low high-frequency resistance. Coil "a" was used in position L<sub>1</sub>, coil "a/2" in positions L<sub>2</sub> and L<sub>3</sub>. It should be noticed that L<sub>2</sub> is used as a reaction coil, but is connected in such a way as to tend to stop the set oscillating, as the coils L<sub>1</sub> and L<sub>2</sub> are brought together. Since both grid and plate of the detector valve are tuned, the set will oscillate readily unless some means is provided to damp the oscillations. This is the sole purpose of L<sub>1</sub>. Its value is unimportant as affecting strength of signal, but for the purpose just mentioned its value is critical, and can best be found by trial. On a roof-top aerial either "a/2" or "a" is suitable for L<sub>1</sub>. The carrier wave of KDKA is very easily picked up with the set oscillating, coils L<sub>2</sub> and L<sub>1</sub> being loosely coupled. The coupling is then tightened until the modulations are isolated from the carrier, the finer adjustments of coupling being made on the micro-condenser N. This set will be found to be extraordinarily stable in operation, and once the tuning points have been noted the station can be picked up practically any night with a minimum of interference to neighbouring receivers.

The set will, of course, operate from a frame aerial, but why go to extremes? A frame always resents people

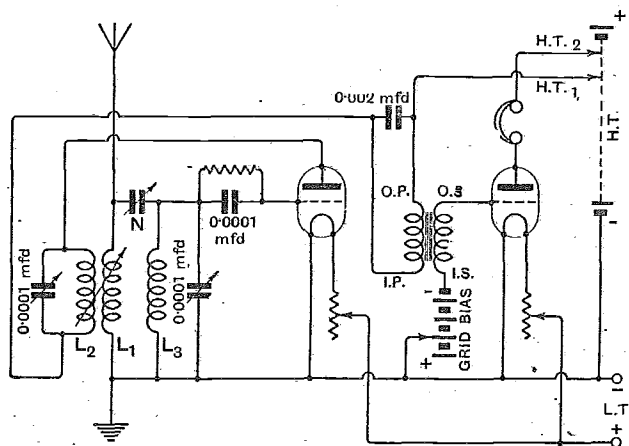

Fig. 1.—Theoretical connections of the set.

SUITABLE COMPONENTS AND PARTS REQUIRED.

- Front panel 10in. × 7in. × 1/4in.
- Cabinet to suit 10in. × 7in. × 7in.
- 2 Variable condensers, 0.0001 mfd. each (Ormond).
- 2 Universal Lissenstats.
- 2 Valve sockets (Hough).
- 6 Terminals 4 B.A.
- 1 Neurodyne condenser (Gambrell).

- 1 0.0001 grid condenser, with 3 megohms leak and clips (Dubilier).
- 1 0.002 fixed condenser.
- 1 2-coil holder (Gambrell).
- 1 Coil block (Gambrell).
- 1 1st stage transformer (Gambrell).
- 2 Black and 2 red wander plugs (A. H. Hunt).

walking about in its neighbourhood, with consequent necessity for readjusting the controls; whereas with an outside aerial the set is sufficiently stable for one to switch over to the loud-speaker and enjoy the concert from a comfortable chair.

By using 0.00025 mfd. variable condensers with verniers, in place of the 0.0001 mfd. listed above, the set, with suitable coils, is available for any other station on any wavelength without alteration.

Success depends on a selection of good, accurately made components, free from both mechanical and electrical defects, assembled and wired in a clean, workman-like manner, and operated with care and patience. The valves used also determine to a large extent the results obtainable with the set.

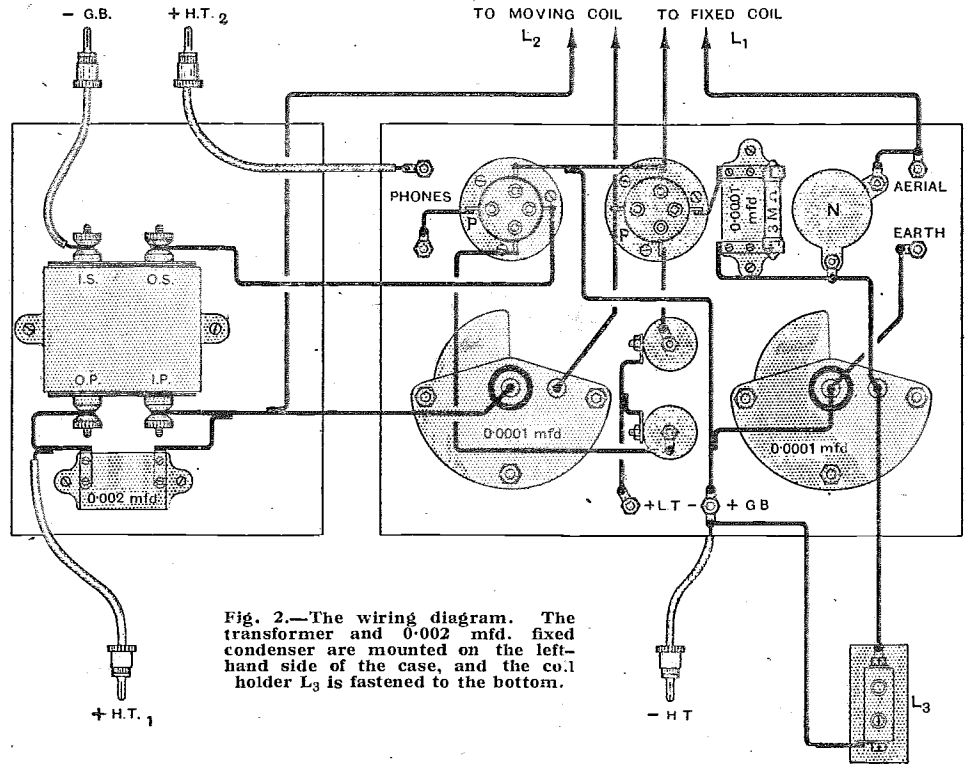
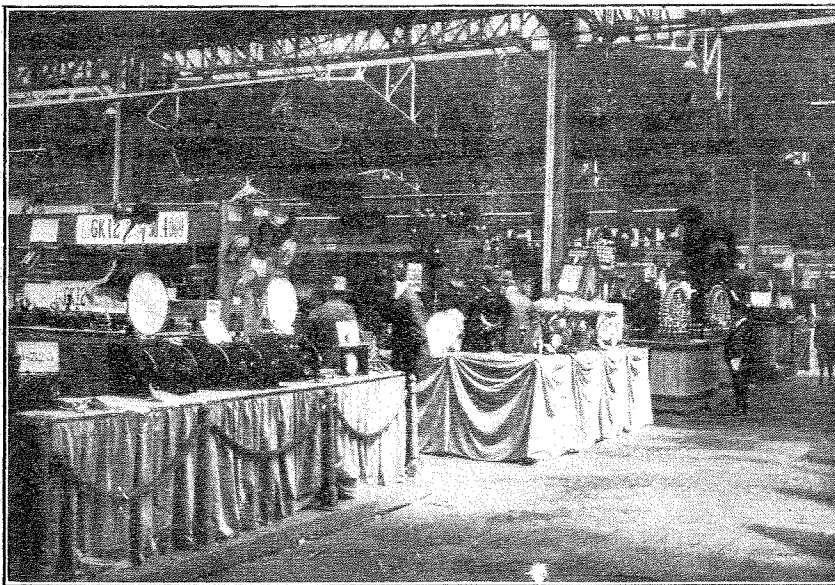

Fig. 2.—The wiring diagram. The transformer and 0.002 mfd. fixed condenser are mounted on the left-hand side of the case, and the coil holder  $L_3$  is fastened to the bottom.

WIRELESS AT THE PARIS FAIR.

THE accompanying photograph gives a glimpse of the wireless section of the celebrated Foire de Paris, which opened this year on May 9th.

The wireless stands, situated in the Hall of Electricity, are arranged in four long aisles. According to reports, they have provided a centre of attraction, great interest being displayed in the numerous novelties presented in the shape of ingenious variable condensers and low-capacity basket coils. The exhibits are also comprehensive in character, and range from the latest catwhisker to a half-kilowatt transmitter. The whole display gives the impression that French manufacturers have made considerable progress in receiver design during the past year.



Wireless stands at the Paris Fair.

# SELECTIVE FOUR VALVE BROADCAST RECEIVER.

Concluding Details  
for its  
Construction and  
Operation.

By W. JAMES.

(Concluded from page 537.)

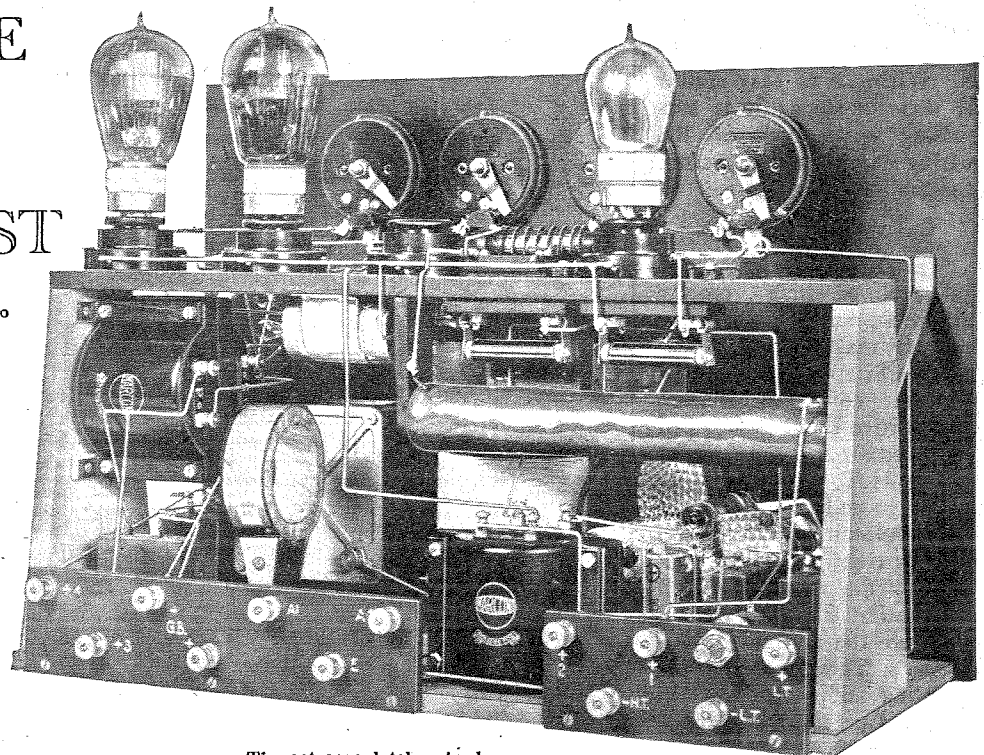

The set completely wired.

### The Closed Circuit Coil.

THE closed circuit coil, Fig. 7, page 537, June 3rd issue, consists of a tube of ebonite, 3in. diameter by 3½in. long. Mounted at the upper end is the reaction coil, and at the lower end the coupling coil.

Three brass feet are also fitted to the lower end for fixing the unit to the baseboard. The reaction and coupling coils are 2¼in. diameter by ¾in. long, and are drilled to take brass spindles ⅜in. diameter, which should be a tight fit. Small pieces of ebonite tube are fitted over the spindles between the movable coils and the closed circuit coil to centre them. These details are clearly shown in Fig. 7, which also shows the connection tags held by No. 6BA screws and nuts. Six of these are required, two for the closed circuit, two for reaction, and two for the coupling coil.

On the large ebonite tube wind 50 turns of No. 24 D.C.C. wire, spacing them slightly and terminating the ends through holes to the connection tags as usual. Wind the reaction coil with 20 turns of No. 36 D.S.C., and connect the ends with flex to the pair of tags provided on the 3in. former. The aerial coil is wound with six turns of No. 30 D.S.C., and the ends are connected with flex to tags on the large former.

This coil unit is mounted on the baseboard in the position shown in Fig. 3, and a hole is cut in the baseboard to allow plenty of clearance for the coupling coil. The spindles are passed through holes in the front panel and fitted with knobs. It was found desirable to earth these spindles—hence they were drilled and tapped No. 8 BA, a tag placed under each screw, and finally the tags connected to earth with flex.

### Wiring the Set.

The set was taken down, and as much of the wiring as possible was put on, first the parts on the panel, then the parts on the valve platform, and then the parts on the base. No. 16 tinned copper wire was used. Then the set was reassembled and the wiring finished off. The

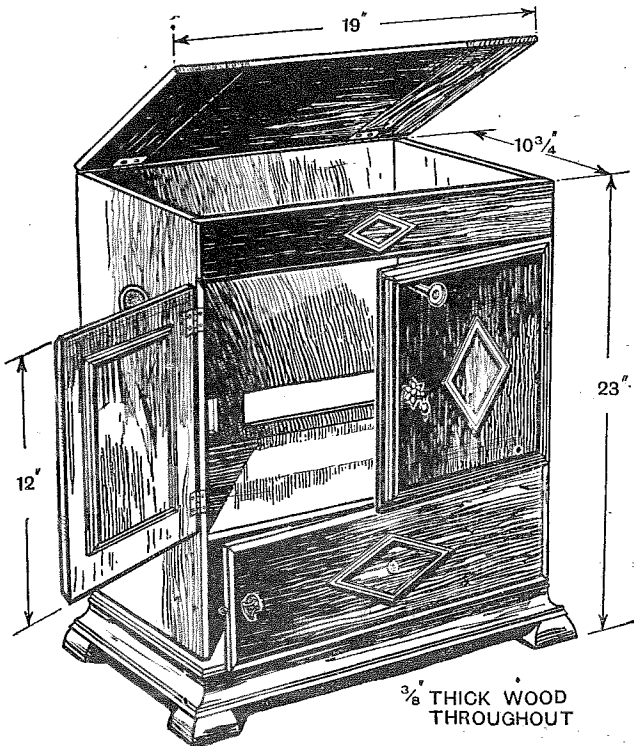

Sketch of the cabinet (Pickett Bros.).

**Four Valve Selective Receiver.**—connections are given in Fig. 8. Wiring is an easy matter if done in steps; it is surprising how much of the wiring can be put on before assembling the panels.

#### Operating the Tuner.

This receiver has four adjustments which require attention, and it is instructive to make these adjustments while watching a milliammeter connected between the positive H.T. terminal of the detector and the tapping on the H.T. battery. With a No. 50 coil plugged in the aerial circuit and with the circuits tightly coupled, that is, with the winding of coil  $L_2$  parallel with that of coil  $L_3$ , note the reading of the meter. Then increase the coupling of the reaction coil, and note that the anode current falls. Now, with the closed circuit condenser set at, say, 50 deg., turn the aerial tuning condenser, and notice that when this condenser is set at a certain value the reading of the milliammeter suddenly increases. This occurs when the two circuits are in tune. If the meter reading has fallen back to its original value the set has stopped oscillating. To make it oscillate again we can either increase the coupling of the reaction coil with the circuit, or we can loosen the coupling of the aerial circuit. The set is most sensitive when it is just off the oscillating point, and the degree of selectivity is highest when the coupling of the aerial and closed circuits is loose.

To tune in a signal, set the coupling coil at about 45 deg., adjust the reaction coil until the set oscillates, and then turn the aerial condenser until the set stops oscillating. Increase the reaction adjustment so that the set is just oscillating when the aerial and closed circuits are in tune. Now advance the aerial and closed circuit condensers a degree or so in steps, making careful adjustments until the signals required are heard. Finally, readjust the tuning condensers and reaction coil, and if necessary, the coupling, remembering that loosening the coupling may make the set oscillate, while tightening it may necessitate increasing the reaction.

It will be found that as the capacity of the condensers is increased, the reaction coil coupling has to be in-

creased. With the set tuned to its highest wavelength, it should be just possible to make it oscillate, and it might be found advisable to adjust the number of turns in the reaction coil to suit the particular aerial system employed. If the aerial is a large one, the number of turns given will be found satisfactory, but if a short aerial is employed, reaction may be made smoother by removing two or three turns.

The number of turns required in the reaction coil to make the set oscillate when the circuits are set at the

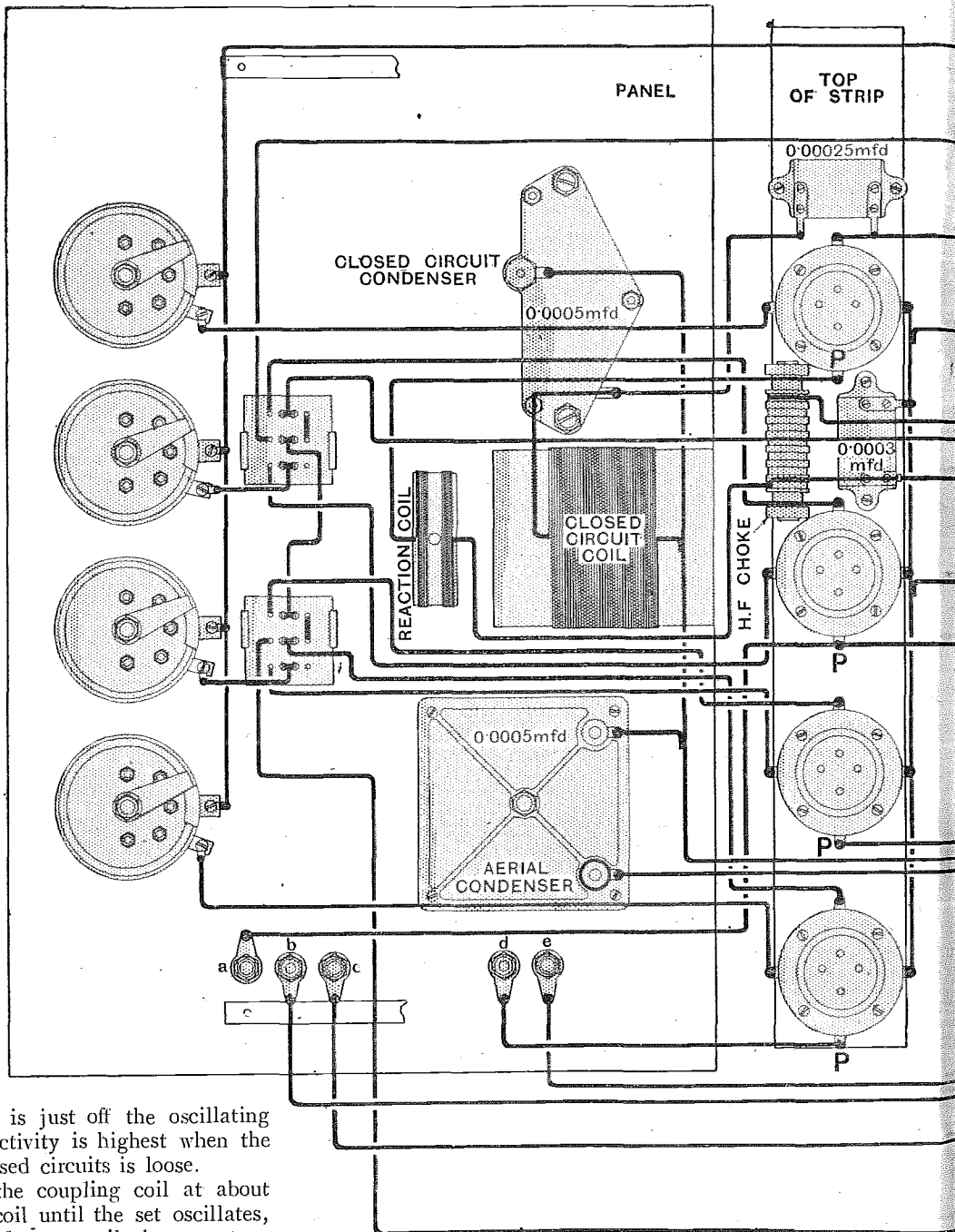
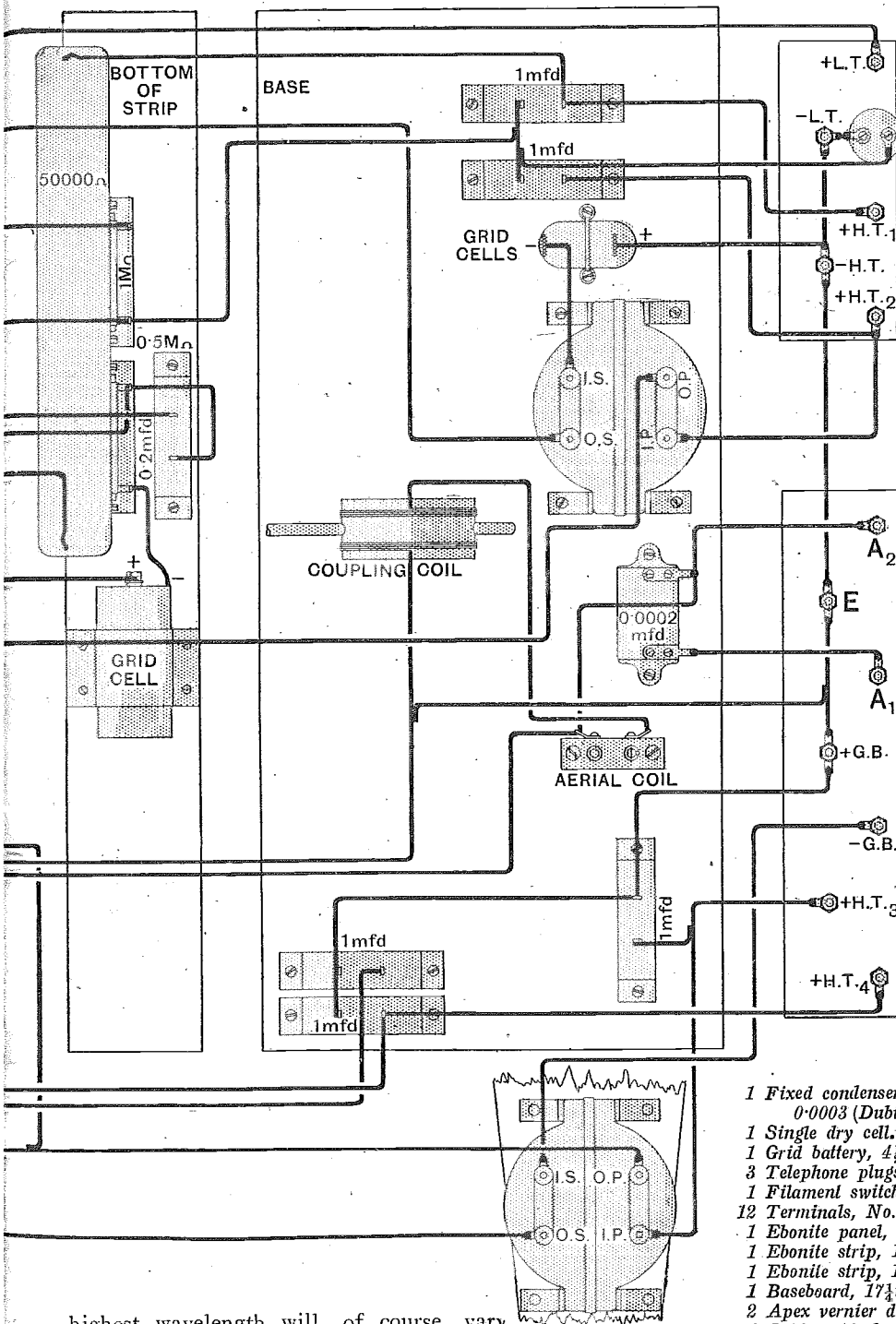

Fig. 8.—Wiring diagram.





highest wavelength will, of course, vary with the value of H.T. applied to the detector. A voltage of 45 is a convenient value when a DE5 valve is used as the detector; if a valve with a higher impedance than that of the DE5 is used it will probably be necessary to use a higher value of H.T. or to put a few more turns on the reaction coil.

It is essential so to adjust the circuit that smooth reaction can be obtained over the whole range. Then the best can be got out of the set. A certain amount of

reaction is, of course, not detrimental to the quality of the results when transformer coupled low-frequency amplification is used.

When a station has been received it is advisable to make a note of the settings of both tuning condensers and of the coupling and reaction coils, as the settings of the condensers for a particular wavelength depend on those of these coils.

With this receiver it should be found impossible to receive the local station with the aerial disconnected from the set, and the selectivity should be such that the factor limiting reception is the ratio of noise to strength of signal—results it is not possible to get with the ordinary three-coil holder type of tuner.

*Materials Used.*

- 1 0.0005 mfd. tuning condenser (Burndept Wireless, Ltd.).
- 1 0.0005 mfd. tuning condenser (Igranic Electric Co.).
- 2 Triple pole throw over switches (Burndept Wireless, Ltd.).
- 4 Dual filament resistances (Burndept Wireless, Ltd.).
- 4 Antiphonic valve holders (Burndept Wireless, Ltd.).
- 1 Transformer ratio 4 to 1 (Marconiphone Ideal).
- 1 Transformer ratio 6 to 1 (Marconiphone Ideal).
- 1 Zenite Resistance rod, 50,000 ohms. (Zenith Manufacturing Co.).
- 2 Grid leaks and clips, 1 megohm and 0.5 megohm (Marconiphone Co.).
- 1 Fixed condenser, 0.2 mfd. (Burndept Wireless, Ltd.).
- 5 Fixed condensers, 1 mfd. (Burndept Wireless, Ltd.).
- 1 Single coil holder.
- 1 Fixed condenser, 0.00025 (Dubilier). 1 Fixed condenser, 0.0003 (Dubilier). 1 Fixed condenser, 0.0002 (Dubilier).
- 1 Single dry cell.
- 1 Grid battery, 4½ volts.
- 3 Telephone plugs and sockets (Burndept Wireless, Ltd.).
- 1 Filament switch.
- 12 Terminals, No. 4 B.A.
- 1 Ebonite panel, 18in. × 12in. × ¼in.
- 1 Ebonite strip, 17½in. × 2½in. × ¼in.
- 1 Ebonite strip, 14in. × 2in. × ¼in.
- 1 Baseboard, 17½in. × 7½in. × ¼in.
- 2 Apex vernier dials.
- 1 Cabinet (de luxe) (Pickett Bros.).

The wavelength range of the closed circuit is 200-550 metres, and the aerial coil should be adjusted to have about this range when the aerial is connected to terminal A1. By connecting the aerial to terminal A2 the wavelength can be increased. A basket coil or a No. 50 coil can be used in the aerial circuit, and the number of turns adjusted to give the aerial circuit the same wavelength range as the closed circuit.

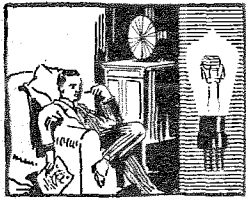

# NEWS FROM THE CLUBS:



Secretaries of Local Clubs are invited to send in for publication club news of general interest.

All photographs published will be paid for.

## Ilford and District Radio Society.

The decision to abolish the entrance fee and to increase the annual subscription to ten shillings was made at the Society's fourth annual general meeting, held on May 26th. Mr. J. E. Nickless has been elected President and Mr. Aston J. Cooper will hold office as chairman during the ensuing season.

The Hon. Secretary is Mr. D. S. Richards, 50, Empress Avenue, Ilford.

o o o o

## Croydon Wireless and Physical Society.

At the Society's last meeting Major John Manley gave a lecture entitled "The Irony of Brains and Progress." In the first part of his lecture Major Manley dealt with the wonders of progressive thought, and made special reference to Sir Oliver Lodge's theory of the ether and electrons. In the second part he gave numerous examples of the ridiculous methods of living in spite of modern science and modern thought.

Hon. secretary: Mr. H. T. P. Gee, 51 and 52, Chancery Lane, W.C.2.

o o o o

## Nottingham and District Radio Experimental Association.

An interesting evening was held on May 27th, when curves were taken of a variety of valves brought by members. The Association now possesses apparatus for calibrating condensers, and in a few weeks it is expected that new instruments will arrive, including a series of standard resistances. The heterodyne wavemeter is being converted for calibrations on the lower band of wavelengths, and it will soon be possible to carry out practically any tests requiring measurements.

Informal weekly meetings will take place regularly during the summer months, a general meeting being held on the last Wednesday of each month.

Hon. Secretary: Mr. M. Allan, 71, Burford Road, Nottingham.

o o o o

## Ipswich and District Radio Society.

An interesting lecture on "The Thermionic Valve, its Functions and Characteristics," was given on Monday, May 25th, by Mr. F. J. Dyer. The lecturer supplied some useful data, and added considerably

## FORTHCOMING EVENTS.

### WEDNESDAY, JUNE 10th.

Radio Society of Great Britain.—Informal meeting. At 6 p.m. At the Institution of Electrical Engineers, Savoy Place, W.C.2. Discussion: "The Application of the Supersonic Method of Reception to Ultra-short Wavelengths," to be opened by Mr. W. K. Alford.

### SATURDAY, JUNE 13th.

North Middlesex Wireless Club.—Field Day.

### WEDNESDAY, JUNE 17th.

Golders Green and Hendon Radio Society.—At 8 p.m. At the Club House, Willifield Way, N.W.11. Demonstration with the Society's apparatus.

### SATURDAY, JUNE 20th.

Eastern Metropolitan Group of Affiliated Societies.—Field Day.

to the value of his remarks by an excellent series of experiments demonstrating the principles of detection and amplification.

Mr. H. E. Barbrook, Hon. Secretary of the Society, has recently distinguished himself by being the first amateur in East Anglia to pick up a programme from the Johannesburg broadcasting station.

Hon. Secretary: Mr. H. E. Barbrook, 22, Vernon Street, Ipswich.

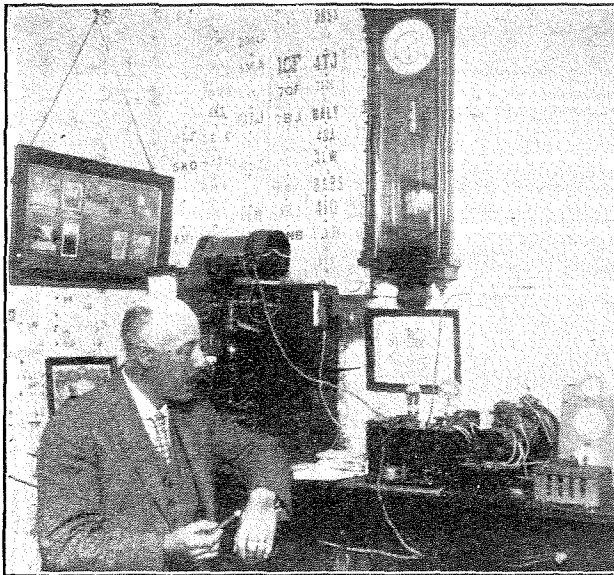

AMATEUR TELEPHONY EXPERIMENTS. Mr. F. L. Stollery (5QV), of Clacton-on-Sea, who has recently been conducting telephony experiments with the assistance of the Clive Parsons Orchestra.

## Stoke-on-Trent Wireless and Experimental Society.

On May 21st an instructive visit was paid to the Accumulator and Wireless Apparatus Works of Messrs. Adams Bros., of Longton. Of extreme interest were the processes of accumulator manufacture, and the party was able to study the methods employed, from the raw material to the finished article. The lead casting shop was first visited, after which an examination was made of the process of mixing the lead oxide for applying to the plates in the form of a paste. In another department the cells were seen undergoing a chemical change under a slow charge of current. In other departments of the works the members were able to study the assembly of condensers as well as the construction of crystal receivers.

Hon. Secretary: Mr. E. A. Haliburton, 73, Stafford Road, Longton, Stoke-on-Trent.

o o o o

## Dublin Wireless Club.

The subject of valve amplification was dealt with very thoroughly by Mr. D. A. McAteer, lecturing on Thursday, May 14th. Having outlined the general principles of valve amplification, Mr. McAteer showed how to determine the amplification factor of different valves. Both high and low frequency amplification were dealt with, and the lecturer pointed out the frequent difficulties of obtaining stable results with different valves of the same type. Interesting comparisons were given to show the difference in current required to operate a loud-speaker during soft and loud passages of music.

o o o o

## Battersea and District Radio Society.

The Society's new five-valve set (1-v-3) is now installed at Headquarters, 374, Wandsworth Road, S.W.8, and is at the disposal of members for experimental purposes every club night. Morse classes are being held, and facilities are given for members to test their own sets and try out new circuits and apparatus. Full particulars of membership can be obtained from the Hon. Secretary, Mr. G. Phillips, 183, Lavender Hill, Battersea, S.W.11.



A Review of the Latest Products of the Manufacturers.

**R.I. CONDENSER.**

Messrs. Radio Instruments, Ltd., of 12, Hyde Street, New Oxford Street, London, W.C.1, are now marketing a square law variable condenser of new design. Electrically it does not differ greatly from the row generally adopted arrangement,

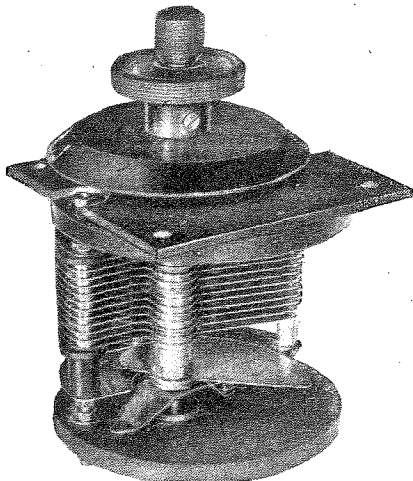

R.I. square law condenser, with heavy brass mounting plate.

excepting that a very low zero is obtained by swinging the moving plates well clear of the fixed plates. Owing to the shape of the moving plates greater spacing at the position of zero setting is obtained from the fixed plates than is usually met with in square law type condensers. The plates are of brass, and are held together

between brass spacing washers and spindles. Mechanically this condenser is a really sound job, with bearings of unusually good construction. The method of holding the spindle in position renders it suitable for accurate work, making use of a calibrated scale.

o o o o

**EFESCA ANTI-CAPACITY SWITCH.**

It is probably due to expense rather than any loss of efficiency which might result that switches are not generally employed in commercial receivers. Added to the range of well-designed switches for amateur use is the new "Efesca" low-capacity type, manufactured by Messrs. Falk, Stadelmann and Co., Ltd., 83, Farringdon Road, London, E.C.1.

It is a lever-actuated switch of attractive appearance, possessing a smooth action produced by sliding a copper-faced ebonite plug between bronze spring contacts. As will be seen in the illustration, the contact blades present negligible capacity one with another, and the connecting bar which moves between them is small, and operated by an action which produces an extremely low capacity to the frame of the switch. Reliable contact is obtained as the switch is moved, and when the lever is rapidly operated it will be found that the circuit connection through the levers is in no way intermittent.

o o o o

**NEW TYPE STERLING CONDENSER.**

Double type condensers are primarily intended for the simultaneous tuning of two circuits, such as two stages of tuned high frequency amplification. In practice, however, double tuning usually fails owing to the difficulty of precisely matching the apparatus in the circuits. This difficulty can be surmounted by providing a balancing control which is independently operated to the movement of the plates, and is capable of giving sufficient adjustment to allow for discrepancies in the two capacities. The Sterling double condenser, which consists of two units of 0.00025mfd. is now fitted with an additional vane giving a to and fro movement between the two sets of fixed plates and controlled by an additional concentric knob. This condenser will be found particularly useful in a number of circuits.

Another development in British condenser manufacture is the introduction of a geared instrument. Operating through a 6 to 1 reduction gearing the revolving vanes move from the position

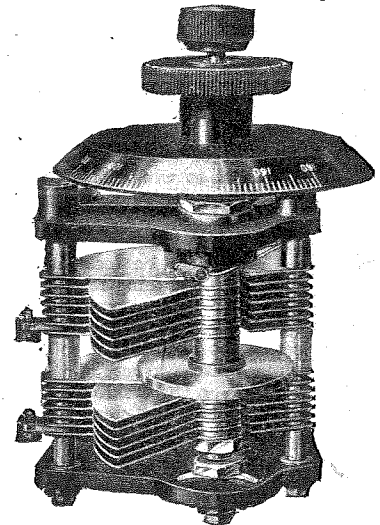

Sterling double condenser with balancing control.

of minimum to maximum capacity by three complete turns of the control knob. The indicator dial is fixed to the moving vanes and thus indicates the actual movement, and there is no backlash in turning the control knob. In other respects these condensers are the same as the well-known Sterling types previously marketed.

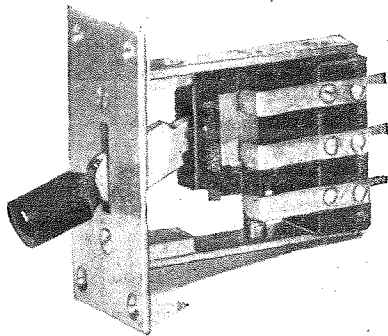

Double pole, two-position Efesca anti-capacity switch.

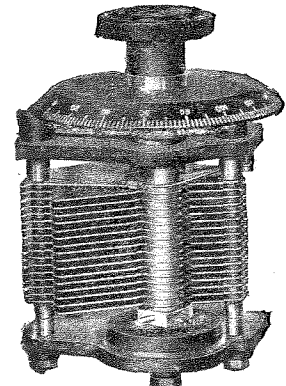

The geared Sterling condenser.

**TAG FOR FLEXIBLE WIRES.**

The General Electric Co., Ltd., Magnet House, Kingsway, have recently introduced a new design of spade terminal. It is nickel-plated to provide a good and durable finish, though the nickelled surface makes it impossible to employ a soldered connection. The difficulty of



G.E.C. spade terminal.

soldering is eliminated by a clever form of clasp having teeth and a small cross-bar which bind down firmly into the flexible wire. The insulating sleeve in sliding over holds the clamp securely closed and produces good electrical contact and a strong mechanical junction.

o o o o

**THE McMICHAEL H.F. DAMPER.**

Users of the well-known McMichael plug-in H.F. intervalve transformers will welcome the introduction of this useful device, which can not only be used to alter the tuning range of the units but also to control the extent to which self-oscillation is set up in the process of H.F. amplification. The McMichael transformers have a hollow centre, and the damper is designed so that it can be inserted as required to modify the tuning range and the damping of the primary and secondary circuits. It is well constructed on an insulating core wrapped with tin foil, and is fitted with a baize washer at the lower end, which grips on the inside walls of the transformer, creating sufficient friction to maintain the damper in any position.

o o o o

**McMICHAEL REACTION UNITS.**

Another device of interest recently produced by Messrs. L. McMichael, Ltd., is a winding suitably mounted for obtaining reaction effects with their intervalve transformers. The winding is carried in eight slots on an

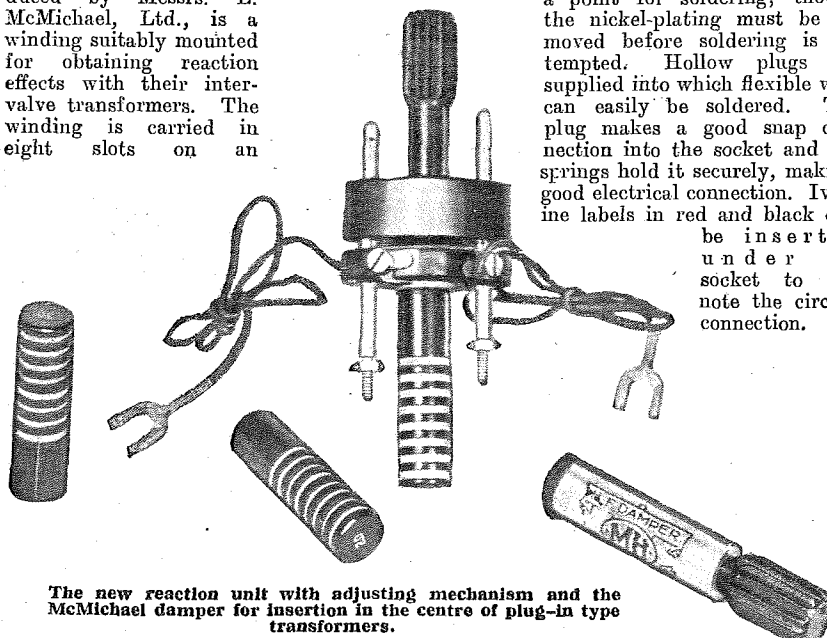

The new reaction unit with adjusting mechanism and the McMichael damper for insertion in the centre of plug-in type transformers.

ebonite former, and is supplied complete with a cleverly designed piece of mechanism which, by means of a screw action, critically controls the extent of reaction coupling. To effectively cover a wide band of wavelengths a range of reaction units is available, which are easily fitted by withdrawing the whole mechanism from a pair of upright guide rods. The rods are screwed into the top plate of the intervalve transformer, and the reaction unit sliding on these rods gives a wide range of coupling, whilst a critical adjustment is obtained by revolving a milled screw. The introduction of a reaction coupling unit will certainly increase the popularity of the plug-in transformer.

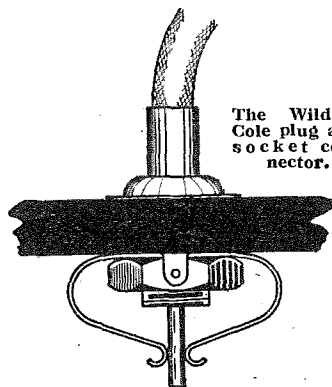

The Wilding Cole plug and socket connector.

**PLUG AND SOCKET CONNECTOR.**

Although essentially intended as a connector for telephone tags, the plug and socket manufactured by Messrs. S. Wilding Cole, 116, Snow Hill, Birmingham, should find many applications in the amateur's set. It consists of a threaded centre bush which is held in to the panel by means of a back nut. The nut holds down the spring connector provided with a point for soldering, though the nickel-plating must be removed before soldering is attempted. Hollow plugs are supplied into which flexible wire can easily be soldered. The plug makes a good snap connection into the socket and the springs hold it securely, making good electrical connection. Ivorine labels in red and black can be inserted under the socket to denote the circuit connection.

**POLAR PRECISION CONDENSER.**

The Radio Communication Co., Ltd., 34-35, Norfolk Street, Strand, W.C.2, have further extended their range of Polar products by the introduction of the Polar Precision Condenser.

Designed for panel mounting, it is provided with one hole fixing, and is supplied complete with a metal graduated metal scale of attractive appearance. The mechanism of the condenser is contained in a plated brass box clamped between moulded end plates, and measures about 1 1/2 in. in depth, so that very little space is taken up in the interior of the instrument to which this type of condenser is fitted. Unlike the well-known Polar condenser, this instrument operates on a moving plate principle, and the thick brass semi-circular plate moves between two fixed plates which are faced with mica. Mica can be relied upon as a satisfactory dielectric in tuning condensers for broadcast reception, though the difficulty hitherto met with has been a mechanical one, inasmuch as mica does not possess a sufficiently durable surface for making a rubbing contact with the moving plate. The problem has been solved in this instance by treating the faces of the mica with a non-drying greasy compound which entirely prevents splintering of the mica, and a good smooth movement results. Reliable contact is made with the moving plate by means of a spiral spring, and both top and bottom bearings are carried by metal bushes.

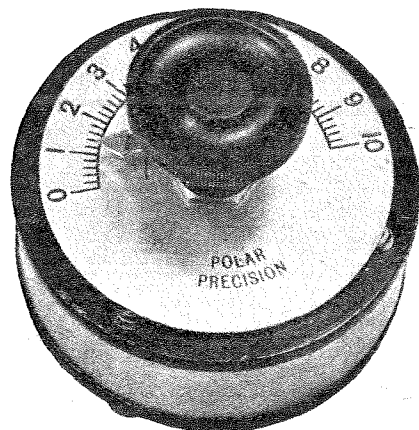

The Radio Communication Co.'s Polar Precision condenser.

o o o o

**MULTIPHONE TERMINAL BUSHES.**

Intended for use as a telephone terminal, the device will be found an improvement on the ordinary screw-down terminal. By means of spring clips, contact can be made with the tags of telephone receivers as required.

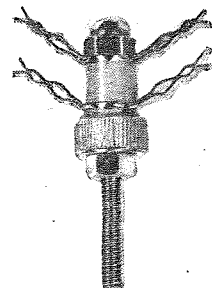

Multiphone terminal for making contact with the tags of several pairs of telephone receivers.

# INTERFERENCE FROM ADJACENT AERIALS.

## The Effects on Crystal Set Reception.

By W. H. F. GRIFFITHS.

(Concluded from page 554 of previous issue.)

### The Mutual Interference Between Two Small Low Aerials Arranged End to End.

Quite considerable energy diminution and augmentation effects were also obtained between the two low aerials Nos. 2 and 3, with No. 1 aerial open-circuited. Receiving on a crystal set connected to the small indoor aerial No. 3 and with the outdoor aerial No. 2 used for interference purposes, the energy absorption curves of Fig. 6 were obtained.

Curve A shows the loss of signal strength when the interfering aerial was tuned to resonance and no load taken from it. Curve B shows that obtained when a 10,000-ohm resistance load "R" was shunted across the tuning circuit "LC," and curve C gives the practical case of a good setting of galena-catwhisker low impedance

crystal shunted across the tuning circuit. The normal value of rectified current obtained during this test with both aerials Nos. 1 and 2 open-circuited was of the order of 4.0  $\mu$ A, and the tuning scale of Fig. 6 is such that

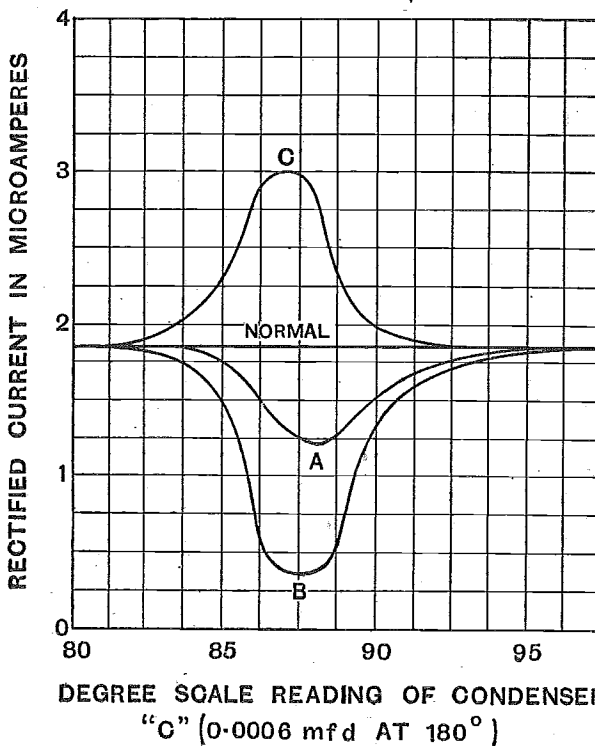
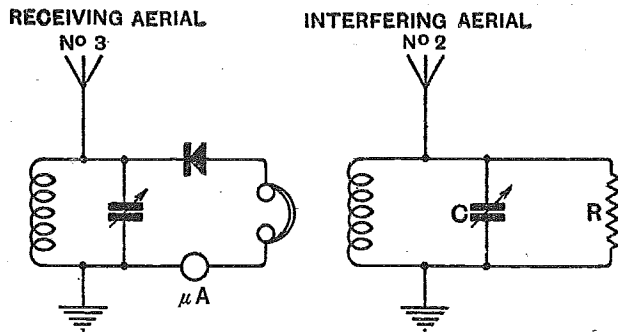
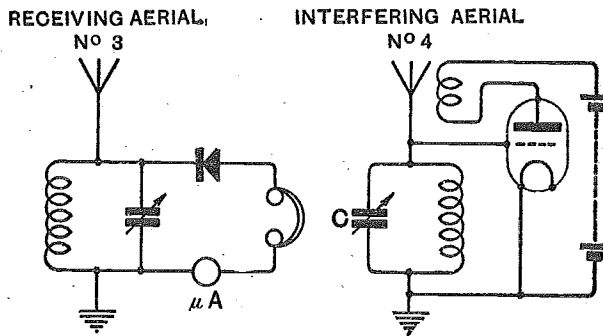

Fig. 7.—Various interference effects between neighbouring aerials.

at resonance 5 degrees correspond to a wavelength change of, roughly, 8 metres. It will be seen, therefore, that practically nothing would be heard under the conditions of curve A for a wavelength band (about the resonance point) of nearly 15 metres in the tuning of the interfering aerial.

Fig. 7 gives curves of signal strength loss and augmentation for the same receiving aerial when the low

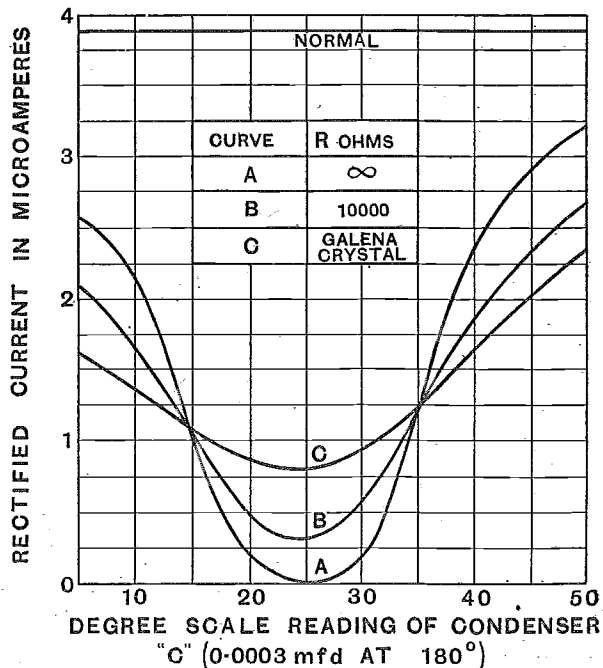

Fig. 6.—The diminution of signal strength due to the tuning of a near-by aerial of equal height and dimensions.

**Interference from Adjacent Aerials.—**

small aerial No. 4, at a distance of about 55ft., was used for the purpose of interference.

The normal rectified current in this test was  $1.85 \mu\text{A}$  with the interfering aerial either short-circuited to earth or left open-circuited. Curve A shows the loss of signal strength when the energy absorbing aerial was tuned and no load taken from it, and curve B shows the still further loss when a very slightly reacting detector valve was connected to the tuned absorbing aerial. Upon increasing the degree of reaction, an increase of signal strength above normal was obtained, as shown by curve C.

**Re-radiation Effects at a Greater Distance.**

With galena crystal reception from a single wire aerial (No. 4), 12ft. high and 35ft. long, a normal rectified

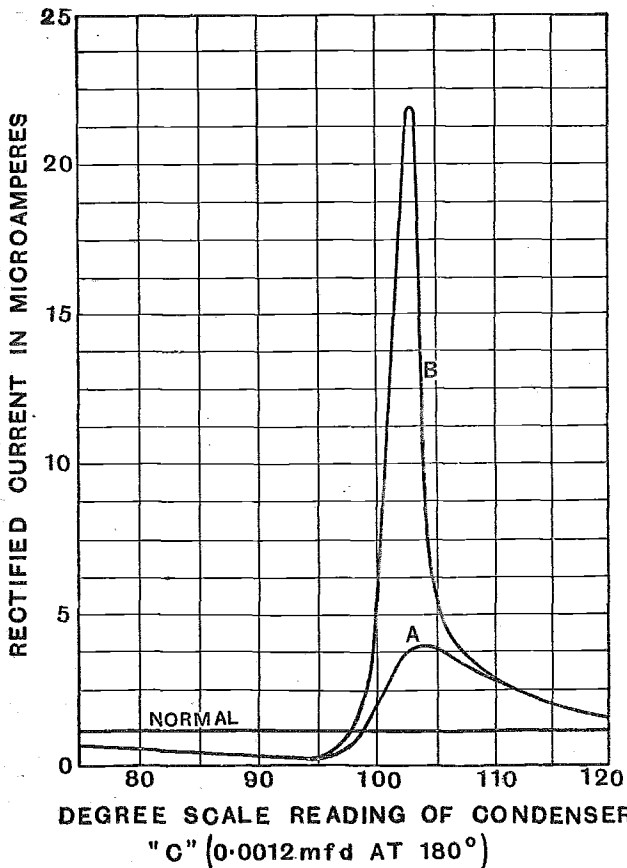
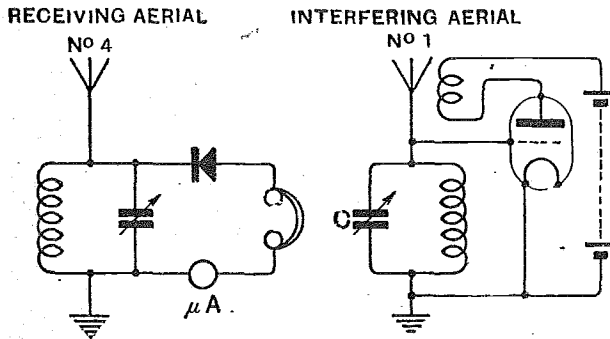

Fig. 8.—The signal strength augmentation from a large neighbouring aerial on which reaction is being employed.

A 38

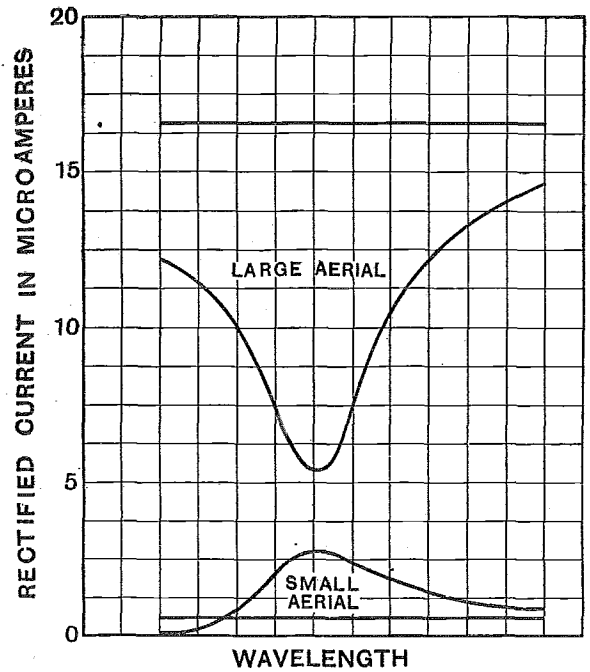

Fig. 9.—Curves showing signal strength diminution and augmentation on large and small aerials respectively, while they were mutually interfering.

telephone current of  $1.1 \mu\text{A}$  was obtained, but when the large aerial (No. 1), about 40ft. away, was also tuned to resonance with the transmission without valve or crystal load, a rectified current augmentation of over 250 per cent. was observed. This increase is shown in curve A of Fig. 8.

Upon the introduction of a reacting detector valve on the large aerial, even when well away from a condition of self-oscillation, the tremendous increase of signal strength represented by curve B was obtained, and by tightening up, still further, the reaction, a 50 per cent. increase on this peak value was observed. These results clearly show the extraordinary magnitude of re-radiation from an efficient receiving aerial whose losses are being negated by the use of reaction, and it is not an exaggeration to say that aerials at distances of hundreds of feet may benefit considerably from these effects.

In comparing the mutual interference properties of the high large aerial and the low small aerial, the curves A (Fig. 4) and C (Fig. 1) prove useful, and are reproduced to the same wavelength tuning scale in Fig. 9. The conditions governing the plotting of these two curves are more or less identical, since they were plotted whilst mutual interference was taking place, *i.e.*, during the same transmission, each having shunted across its oscillatory circuit a high resistance perikon crystal. It will be observed that at resonance, while the crystal load on the small aerial was not sufficient to prevent that aerial from absorbing energy, a similar load on the large aerial was not sufficient to prevent some of its energy from considerably augmenting that of the small aerial.

In conclusion, it should be mentioned that the term "re-radiation" has been used, somewhat loosely perhaps, to convey the idea of the total transference of radio-frequency energy from one aerial to another.

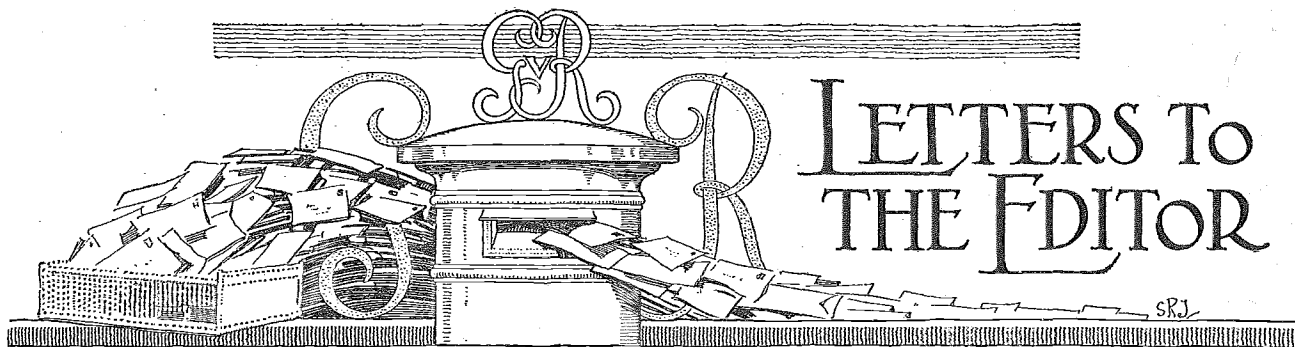

# LETTERS TO THE EDITOR

The Editor does not hold himself responsible for the opinions of his correspondents.

Correspondence should be addressed to the Editor, "The Wireless World," 139-140, Fleet Street, E.C.4, and must be accompanied by the writer's name and address.

## RESULTS WITH AN ARMSTRONG SUPER.

Sir,—Having recently "hooked up" a single-valve Armstrong super, I wondered if the results obtained would be of interest to you. An indoor aerial is used consisting of five 16ft. wires along the ceiling. The earth lead goes 20ft. to a water tap. The range of the set as a super is roughly 400 metres to 25-30 metres. It was completed on April 25th, and on April 26th KDKA was heard on 65 metres at 12.40 a.m., very loud reception continuing until 4.10 a.m.

On several occasions since then I have heard the following in slow Morse on 50 metres:—"CQ de YZ. Study short waves propagation. Please send letter to Lecroart, Fort Issy, Seine, France."

These signals were R7, no aerial or earth being used.

On May 2nd, KDKA's programme was received from 2.10 a.m. to 4.10 without aerial or earth. Owing to strength of signals, the loud-speaker was switched on, and a 24-ft. extension connected to the room below. Signals were readable anywhere in the 12-ft. room from the loud-speaker.

The set is tricky to tune, but once tuned is very stable.

Birmingham. A. E. DUCKETT.

## EFFICACY OF H.F. AMPLIFICATION.

Sir,—Referring to the letter in the May 13th issue of *The Wireless World* on the above subject, I see that this thorny question has come up again. I think that the following facts might be mentioned.

(1) There is no difficulty in making up a really efficient H.F. stage if elementary principles are remembered.

(2) If volume is required, a detector valve (using grid rectification and reaction), followed by a transformer-coupled L.F. stage, is better than an efficient H.F. stage followed by a detector.

(3) Loose coupling with a H.F. stage has the same effect as reaction, the damping effect of the aerial circuit being reduced as the coupling is loosened.

(4) The detector with grid rectification and reaction is one of the many causes of distortion.

(5) Anode rectification and crystal rectification, if properly used, give distortionless results, and there is little to choose in efficiency.

In my own humble opinion, if one is limited to two valves, the best combination for general purposes is a loose-coupled circuit, a H.F. stage and crystal rectification followed by a L.F. stage coupled by a high ratio transformer. This combination, followed by the necessary number of stages of resistance-coupled L.F., gives wonderfully pure loud-speaker reproduction.

Derby. H. H. DYER.

Sir,—With reference to the paragraph on page 493 of *The Wireless World* of May 20th, regarding the difficulties of tuning two H.F. circuits, we beg to draw your attention to the fact that this trouble is entirely overcome by the use of W. & M. double-coupled vernier condensers, inasmuch as they are specially made so that the number of fixed plates in the section to which the vernier is attached is one less than in the other section. By this means the capacity of this section

is less than that of the other section by the capacity of one surface of a moving plate. The full capacity of the vernier (three-plate) is two surfaces of a moving vane. Thus the vernier gives an adjustment of one vane surface above and below the capacity of the other section, allowing for balancing of two slightly unequal coils. For example, in the 0.0003 mfd. if the capacity of one surface be taken as one the total capacity of the section remote from the vernier is sixteen (eight movable and nine fixed vanes). The capacity of the section attached to the vernier is fifteen (eight movable and eight fixed vanes). The capacity of the vernier itself is two. This section with the vernier has a capacity of fifteen to seventeen according to whether the vernier is full in or out. Then if two slightly unequal coils are in use they can be balanced whether the coil connected to the vernier section be the larger or smaller.

ERNEST WAINWRIGHT,

Managing Director, Wainwright Manufacturing Co., Ltd.  
Walthamstow, E.17.

## BROADCASTING IN BOMBAY.

Sir,—I observe under the heading "Broadcast Brevities" in your issue of April 22nd last your paragraph "India's Wireless Boom." As this paragraph is misleading and very likely to give rise to undue optimism in the trade at home, I think it as well to advise you that we are not in the throes of a wireless boom or likely to be. No programmes have been or are being given in the public parks here (with the exception of one demonstration), although there is a probability of this, to a very limited degree, in the near future, as the municipality have purchased an open-air loud-speaker equipment and will periodically reproduce the programmes broadcast by the local club. But to say that continuous programmes are being given daily in the public parks and that people flock thither in thousands is entirely wrong. Further, the receiver licence fee is Rs.10 per annum and not £1.

"BOMBAY."

## 5XX HEARD IN INDIA.

Sir,—In *The Wireless World* for April 1st you publish a report from a Bombay radio engineer regarding his reception of 5XX. It may interest you to hear that I received this station every night last winter at good 'phone strength. The set used contains three valves (1-v-1), constructed five years ago in England and still employing two of the original Marconi R. type valves. My aerial consisted of a single 7/22 copper wire, 130ft. in length, with an average height of 25ft. above the ground. Using an extra high-frequency valve connected externally to the set music and speech were good on a small Brown loud-speaker, the Savoy bands coming through exceptionally well. Using the same set I received the concerts from Eiffel Tower on many occasions. The set was situated at Dardoni in Waziristan, completely surrounded by mountains and hills. I might state that I have been a reader of your excellent paper since its inception. Wishing all future success to *The Wireless World*.

Kohat, India. L. G. PINNALL,  
Flying Officer, R.A.F.

**DISPENSING WITH THE OUTSIDE AERIAL.**

Sir,—I have pleasure in giving particulars of a simple and effective means of enjoying the freedom and pleasure of "listening-in" to distant broadcasting stations—on a "loud-speaker"—without an outside aerial.

This is effected by the use of two earths—one wire running from the "earth terminal" on the "wireless receiver"—to say, the lavatory waterpipe, and another wire running from the "aerial terminal" on the receiver, carried along the floor through the window to a copper tube driven into the ground. This wire should have a 0.001 mfd. variable condenser in series mounted upon an ebonite panel with two terminals. A plug-in coil holder, with plug and socket, should be connected in parallel with the variable condenser.

In the case of the aerial coil holder fixed in the ordinary manner upon the instrument, with the usual 0.0005 mfd. variable condenser in parallel, a 75 turns plug-in coil should be inserted, instead of the usual 35 or 50.

The size of the anode coil on the receiver remains, as usual, say, 75 turns. The anode reaction, say, 100 turns—instead of 75.

At first, until confidence is gained, a little extra time and care may be found to be necessary in "tuning-in" stations, owing to the sharpness of tuning.

To me, it is quite simple and easy. Good tuning, in any case, is a matter of skillful handling, especially in "cutting-out" other stations, the sensible use of reaction, and avoiding unnecessary oscillation.

My own experiences convince me that the unsightly outside aerial in the near future will be found to be unnecessary.

R. F. LEWIS SMITH.

Maida Hill, London, W.9.

**RECEPTION OF 20-METRE SIGNALS.**

Sir,—The following account of the reception of signals from NKF, Washington, on 20 metres may interest those who are just starting to experiment in the reception of short waves, and also those who have been experimenting for a longer time but are more or less mystified at the strange happenings on these short waves.

These signals were transmitted during the first ten minutes of every hour from 2 p.m. to 2 a.m., on April 27th and 28th, and 2 a.m. to 2 p.m. on April 29th. The general weather conditions here were good, the barometric pressure being fairly steady, with a tendency to rise, the average being 29.30 inches.

The signals were considered very steady throughout the period of audibility, and quite free from any variation in wavelength; they were, however, subject to fading or swinging at all periods, and during the period when signals were weak according to the

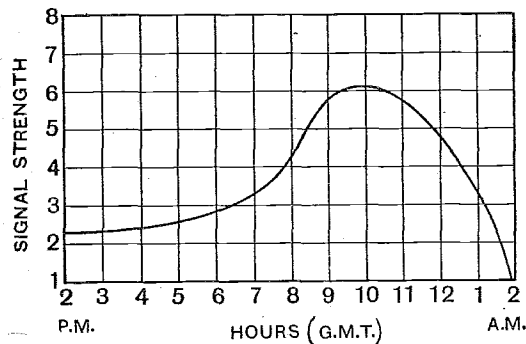

Fig. 1.—This graph was plotted to show the strength of short-wave signals received across the Atlantic from 2 p.m. to 2 a.m.

graphs, the minimum strength of signal reached the zone of inaudibility, and during the maximum strength periods the signal would swing to the weak but readable zone. The time of swing varied but slightly, and was from 5 to 10 seconds.

It will be seen from fig. 1 that signal strength increased very gradually up to within an hour of sunset, and this was followed

by a marked increase from sunset to 10 p.m., G.M.T., after which will be observed a steady decrease in strength up to the point at 2 a.m., G.M.T.

From fig. 2, it will be observed that the action is most uncertain, and only the faintest trace of signal could be found at 2, 3, 8 and 10 a.m.; at 12 noon the signals were readable, but again showed a slight decrease at 2 p.m., at which time the tests ended.

It can therefore be gathered from the foregoing notes that the signals from the 75th meridian are audible at a point roughly 4 degrees West of Greenwich for a period of 14 hours, all other times being uncertain, and probably subject to variations over wide limits. It has also been observed that the signals from the various districts in the United States are subject to the same variations as regards increase in strength from the point where the sun is speeding westward and within a few degrees to the horizon when observed from the receiving station. On the other hand, in the case of stations using low power,

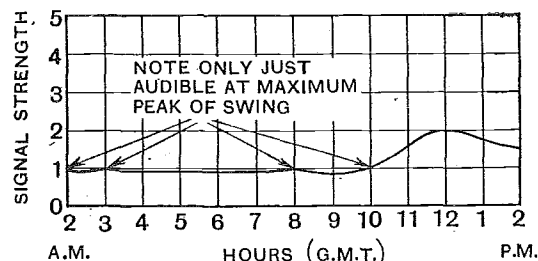

Fig. 2.—Remarkable diminution in signal strength was observed during the early morning hours, as the above graph shows.

they are reaching the inaudibility zone much sooner than others who are using higher power, reference being to 9XAX and 1XAM, who have been heard sending test transmissions by means of some form of automatic key, and other American amateurs who have been heard working with their fellow amateurs. In the majority of cases their signals have been very difficult to copy at midnight G.M.T., and will give a very fair average of the state of signals from various U.S. stations, the only difference being in the signal strength for any given time as compared with signals from NKF.

The most strange observation made by the writer on these short waves, is the great difficulty, and in some cases, total failure, to pick up stations working at a distance of only 200 miles, while at the same time the signals are being reported as strong by American amateurs, and no difficulty whatsoever is experienced in copying the replies from a distance of 3,000 miles. I am of opinion that these short waves are subject to very strong sunlight influences. The transmitted waves travelling in the parallel plane are absorbed very quickly by earth conduction, and the waves which travel in the perpendicular plane are reflected to very great distances with but little loss of energy, but it still remains to be found whether the waves are reflected at high or low angles having few or several points of maxima and minima in the course traversed, and further study of this interesting band may later give some very important data. It can, however, be seen at a glance that the position of the sun at any given hour has a marked effect, which shows that the condition of signal is dependent on the state of the atmosphere directly under the ionising influence of the sun's rays, and possibly the distance that can be covered depends entirely on this factor.

In conclusion I would point out that the receiver used during these tests consisted of a detector, one transformer-coupled L.F., and one choke-coupled L.F., the aerial coupling coil being fixed at a distance of 3 inches from the tuned circuit, and all batteries were carefully checked a few moments before each hour throughout the test. The reaction condenser was also left untouched after finding the best position for the first test signal, and the wavelength was so steady throughout that the tuning condenser was only adjusted a few times. This was most important and was of utmost assistance to those who listened in order to find the necessary data concerning the propagation of these ultra short waves.

Holyhead.

R. E. WILLIAMS.



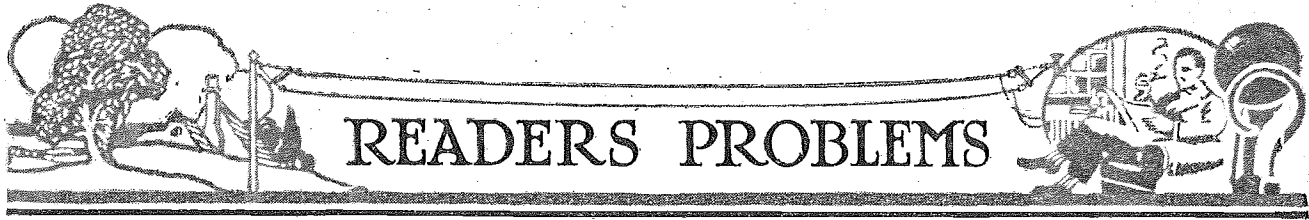

READERS PROBLEMS

Readers Desiring to Consult "The Wireless World" Information Dept. should make use of the Coupon to be found in the Advertisement Pages.

Design of Set for Outdoor Demonstration Work.

It not infrequently happens that we receive enquiries for a powerful receiver suitable for the operation of a very large loud-speaker for the purpose of outdoor demonstrations or for dancing purposes in a large hall. The first requisite is ample volume, with high quality of reproduction. In order to produce high quality there is no need to resort to the use of a resistance-coupled amplifier, since it is possible to produce this with a combination of transformer and choke coupling, thus effecting not only a saving in the number of valves but also a reduction in the required value of H.T. We illustrate in Fig. 1 a circuit which can be thoroughly recommended for the purpose. Since a high-frequency valve is used with a very delicate method of control over reaction, not only is it possible to receive the more distant stations at excellent volume on a large loud-speaker, but the local station can be received at similar volume on a very small improvised aerial. In order to eliminate the H.F. stage when it is not desired, it is only necessary to turn out the filament of this valve, when it will be seen that we have a loose coupled detector valve with reaction, since the anode coil of the H.F. valve is also the grid coil of the detector valve. Thus, in the event of any annoying interference developing during a time when a special demonstration is being given, resort can be had to a loose-coupled detector valve, which should cure the trouble, and provided that a reasonably efficient aerial and earth system is used, it should be possible by means of loose coupling to cut out the local station and bring in a more distant station. Care should be taken with regard to the electrical connections of this "anode-grid" coil. The connections of the normal reaction coil should first be adjusted in the ordinary way, with the third coil moved well away from the aerial and reaction coils. The remaining coil should then be brought into the sphere of influence of the other two, and its connections adjusted so that it acts to assist the ordinary reaction coil. In this way it will be found that when using the H.F. valve a very delicate control is had over regeneration, with a consequent increase in selectivity and sensitivity.

With regard to the first stage of L.F., a transformer is used, since it is always desirable to give an initial voltage step

up to the signals immediately after rectification; in this way considerably more amplification will be obtainable at the output terminals of the amplifier. It is of paramount importance to use a transformer having a very high impedance primary. Such an instrument can usually be recognised by its low turns ratio, which is of the order of two or three to one.

low capacity type in an adaptor for the H.F. stage, in order to secure greater efficiency and ease of operation in this portion of the circuit. Since the impedance of the last valve will be very low and the plate current large, it will be desirable to use a loud-speaker in which provision is made to place the windings of the two magnets in series or parallel. When the windings are in parallel, not

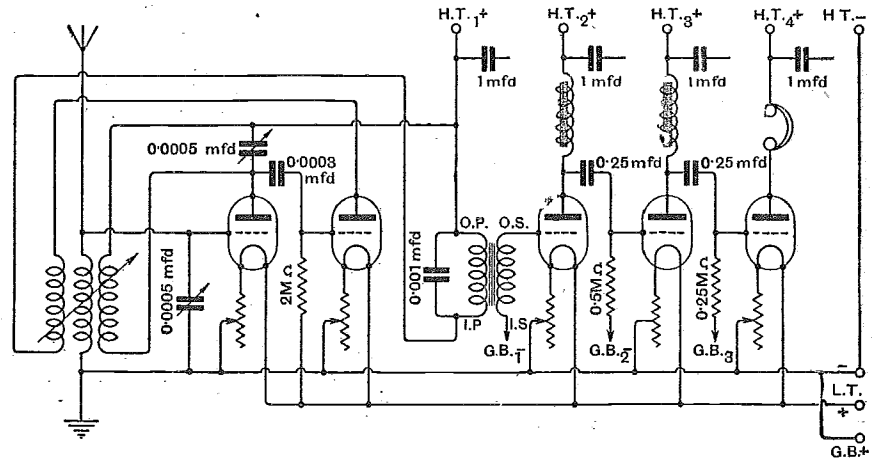

Fig. 1.—A receiver with 1 H.F., valve detector, and three stages of L.F. magnification for good quality reception.

The second and third stages of amplification are choke-coupled in order to maintain high quality of reproduction. Care should be exercised to see that these chokes have a sufficiently high value of impedance. The windings of an intervalve transformer connected in series will form an excellent choke for this purpose.

The values of other components in the L.F. amplifier which we give should also be adhered to. Since three stages of L.F. amplification are used, it is imperative that a valve having a very large permissible value of grid voltage swing, such as an L.S.5.A., be used in the final stage. The other valves of the L.F. amplifier should also be of the low impedance power valve type. Suitable valves to use in the three stages of the amplifier would be of the D.E.5.B, and the L.S.5, and the L.S.5.A. type, with, of course, the correct value of H.T. and grid bias applied to each individual valve. The H.F. and detector valves can be of the ordinary general purpose type, with a common H.T. + connection. It would, however, be advantageous to employ a valve of the

only will the resistance be lowered, thus making it more suitable for use after a low impedance valve, but since the two windings are in parallel the plate current load will be divided equally between the two windings, thus obviating the risk of damaging the windings due to excessive current. If used after an ordinary valve the windings can, of course, be used in series.

If it is desired to use a loud-speaker in which no provision is made for placing the magnet windings in parallel, it will be advisable to use an output transformer of 1 to 1 ratio.

o o o o

L.F. Transformers—High or Low Ratio?

In spite of information repeatedly given in the pages of this journal, readers constantly query the correct ratio of transformer required to be used in the first and second stage of an L.F. amplifier.

In order to secure best results from the point of view of high quality of reproduction it is necessary that the impedance of the primary of an L.F. transformer

which is connected in the anode circuit of any valve be two or three times that of the valve. Since the impedance of an ordinary detector valve is high, it is necessary that the impedance of the primary of the transformer which follows be high also. This calls, among other things, for a large number of turns on the primary, and if a large-turn ratio were used it is obvious that the total space required by all the turns would be very great, which would have the effect of making the finished instrument very bulky indeed, quite apart from the fact of the detrimental effect of the high self-capacity which would be introduced. Hence it becomes necessary to reduce the number of turns on the secondary to a reasonable number, with a consequent reduction in turns ratio. Thus it comes about that a transformer having a high impedance primary is usually of low ratio, and since a high impedance primary is necessary when following an ordinary high-impedance "R" type detector valve it is customary for a low-ratio transformer to be specified for the first stage. Of course, it should be remembered that a low-ratio transformer does not necessarily have a large number of turns on the primary, consequently it is usually preferable to employ a high-ratio transformer of reputable make rather than a low-ratio one of doubtful quality. Since it is now customary to employ a low-impedance power valve in the first stage of an L.F. amplifier, the second transformer which follows it obviously does not require so large a number of turns in its primary, and so a higher ratio is permissible; but if an ordinary high-impedance "R" valve is used in the first stage a low ratio is again called for. It will be seen from the above, therefore, that when choosing a transformer it is at first necessary to take into consideration the type of valve which will precede it.

o o o o

#### An Efficient Long-distance Single-Valve Receiver.

A CORRESPONDENT wishes to construct a single-valve receiver with which the utmost range on headphones can be obtained. He does not wish to make use of a dual amplification circuit, nor does he wish to experiment with the super-regenerative principle, but prefers to make use of a conventional circuit which is reliable and stable. The set is to be adaptable to a wide band of wavelengths by making use of plug-in coils.

The circuit which is given in Fig. 2, while making use of conventional principles, has one or two refinements added which make all the difference between success and failure when attempting to receive long-distance stations. In the first place a variable grid leak is incorporated. Whilst the conventional value of 2 megohms is correct for all ordinary purposes, it is often desirable, especially in the shorter wavelengths, that a means of varying and critically adjusting this value be had. In many cases it is desirable to exceed the conventional five megohms maximum value usually given. Since really reliable com-

### BOOKS FOR THE HOME CONSTRUCTOR

*Issued in conjunction with "The Wireless World."*

"THE HOME CONSTRUCTOR'S EASY-TO-BUILD WIRELESS SETS," by F. H. HAYNES. Price 1/6 net. By Post, 1/9.

"TUNING COILS AND METHODS OF TUNING," by W. JAMES. Price 2/6 net. By Post, 2/10.

"HOW TO BUILD AMATEUR VALVE STATIONS," by P. R. COURSEY. Price 1/6 net. By Post, 1/8.

"THE CONSTRUCTION OF AMATEUR VALVE STATIONS" by Alan L.M. DOUGLAS. Price 1/6 net. By Post, 1/8.

"THE HOME CONSTRUCTOR'S WIRELESS GUIDE," by W. JAMES. Price 3/6 net. By Post, 3/9.

"MAST AND AERIAL CONSTRUCTION FOR AMATEURS," by F. J. AINSLEY, A.M.I.C.E. Price 1/6 net. By Post, 1/8.

*Obtainable by post (venittance with order) from*  
**ILIFE & SONS LIMITED,**  
Dorset House, Tudor St., London E.C.4,  
*or of Booksellers and Bookstalls*

ponents having a range similar to that given in the diagram are now obtainable, this refinement can be readily added with great advantage. The addition of the potentiometer is another very desirable feature, since it is not true in the case of every valve to say that it functions most efficiently as a rectifier when the grid return lead is connected to the positive end of the low-tension battery. The addition of this feature is certainly well worth its expense. It is advisable also to use a vernier coil holder of the geared type in order to secure a fine control over reaction, whilst this control is rendered considerably more delicate by the inclusion of the .0001 mfd. variable condenser

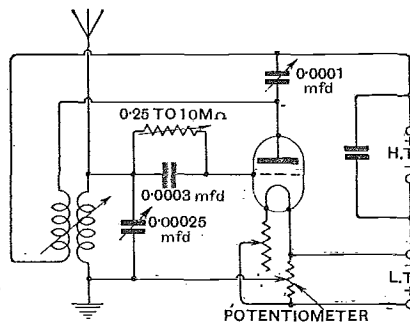

Fig. 2.—An effective single-valve receiver.

in shunt with the reaction coil. The purpose of this component is not to bring the anode circuit of the valve into resonance with the grid circuit, since this would tend to produce instability, but its purpose is to shunt some portion of the H.F. oscillating current away from the reaction coil. By this method a very fine control is obtained over the magnetic linkage between the aerial and reaction coils.

A further point to note in designing a circuit with the object of securing extreme ranges is to use a large inductance coil and a small condenser for aerial

tuning. The condenser is preferably of the low loss type fitted with some form of high ratio geared control. Commercial plug-in coils may be used, or much scope is left to the amateur in making his own low loss inductance coils. The number of turns on the reaction coil should be as few as possible, certainly no more than is necessary to produce oscillation. This will mean a coil having a considerably less number of turns than is usually employed in this part of the circuit. On the shorter wavelengths it is recommended that an aperiodic coupled tuning coil be used, a component which may be either home constructed or purchased from many manufacturers of plug-in coils. An anti-capacity type of valve holder is to be preferred to one of the ordinary type, whilst the use of a really reliable vernier rheostat of the carbon compression type is an advantage.

Provided that these refinements are carried out, and that attention is paid to the elimination of losses in the wiring, it should be possible to tune in most of the British and Continental stations on a single-valve receiver of this type, whilst one or two American broadcasting stations are by no means outside the bounds of possibility.

o o o o

#### Uses of a Milliammeter.

A CORRESPONDENT is desirous of knowing the correct position in the circuit to include a milliammeter which he has obtained for use with his four-valve set, and he suggests connecting it between the H.T. and L.T., in place of the usual connection which exists there. This is, of course, quite incorrect, and in this position the instrument will serve no useful purpose whatsoever, except the rather unimportant one of indicating the value of the total current being drawn from the H.T. battery. Arrangements should be made by suitable means to include the instrument in the anode circuit of any of the four valves as desired. When connected in the anode circuit of either of the L.F. amplifiers it will serve a very useful purpose, as it will enable us to adjust correctly the H.T. voltage and grid potential of the valve in question. Provided that the needle remains stationary at a given value and shows no appreciable movement when signals are coming in, all is well, but should the needle fluctuate in an irregular manner, the value of the applied grid bias should be adjusted, and if this is not effective the H.T. voltage value must be varied, and then a further adjustment made of grid bias battery. This should cause the pointer of the milliammeter to cease its fluctuations, but should it not do so, as might be the case when very strong signals were being received, especially in the case of the second L.F. valve, it indicates the necessity for replacing the existing valve with one capable of handling a larger input of power; for, of course, the fluctuation of the needle indicates that rectification is taking place, due to the excessive voltage swing on the grid carrying the anode current to the lower or upper bend portion of its characteristic curve.

# The Wireless World

## AND RADIO REVIEW

No. 305.

WEDNESDAY, JUNE 17TH, 1925.

VOL. XVI. No. 19.

Assistant Editor:  
F. H. HAYNES.

Editor:  
HUGH S. POCOCK.

Assistant Editor:  
W. JAMES.

Editorial Offices: 139-40, FLEET STREET, LONDON, E.C.4

Telephone: City 4011 (3 lines).

Advertising and Publishing Offices: DORSET HOUSE, TUDOR STREET, LONDON, E.C.4.

Telephone: City 2847 (13 lines).

Telegrams: "Ethaworld, Fleet, London."

COVENTRY: Hertford Street.

BIRMINGHAM: Guildhall Buildings, Navigation Street.

MANCHESTER: 199, Deansgate.

Telegrams: "Cyclist Coventry."  
Telephone: 10 Coventry.

Telegrams: "Autopress, Birmingham."  
Telephone: 2970 and 2971 Midland.

Telegrams: "Hiffe, Manchester."  
Telephone: 8970 and 8971 City.

Subscription Rates: Home, £1 1s. 8d.; Canada, £1 1s. 8d.; other countries abroad, £1 3s. 10d. per annum.

As many of the circuits and apparatus described in these pages are covered by patents, readers are advised, before making use of them, to satisfy themselves that they would not be infringing patents.

### PROGRESS IN STANDARDISATION.

THE question of standardisation of materials and parts in general use in radio work has attracted attention for some considerable time past, and the introduction of standards has been a part of the policy of the Radio Society of Great Britain. It is largely due to the activities of this body that definite steps to bring about standardisation are now being made.

At the request of the Radio Society and the Ebonite Manufacturers' Association, the British Engineering Standards Association set up a committee some months ago to determine a British standard for ebonite for radio purposes. More recently the Radio Society approached the British Engineering Standards Association to call a meeting of all concerned, to consider the advisability of forming a committee for the standardisation of wireless apparatus and components. A conference took place on May 25th, when representatives were present of the Radio Society of Great Britain, the British Engineering Standards Association, the National Association of Radio Manufacturers and Traders, other manufacturers, the Valve Manufacturers' Association, the Wireless Section of the Institution of Electrical Engineers, the British Broadcasting Co., the Wireless Retailers' Association, the Wireless Board, the General Post Office, and the technical Press. The conference was unanimous in the opinion that it was very desirable that standards should be arrived at, and the British Engineering Standards Association stated it was prepared to assist

in drawing up such standards with the co-operation of other organisations.

The *Wireless World* has taken a deep interest in the progress made towards standardisation, and we believe that the setting up of such standards, accepted by the trade and other interests, will have a far-reaching and beneficial effect which the public will not be slow to appreciate.

Although we must not expect that standards for every article and material can be drawn up in a short time, yet we hope that every effort will be made to speed up the work, because there will be an unavoidable lag between the time when standards are accepted and their influence becomes operative. There is, at present, a very wide divergence in the electrical values and electrical quality of materials and components, quite apart from the fact that there has so far been little or no attempt to standardise physical dimensions. With the steady influx of apparatus and radio materials from abroad, the necessity arises more than ever for some standard of quality to be adopted in this country. Not until such standards have been set up will it be possible for the average consumer to feel safe in the purchase of

### CONTENTS.

	PAGE
EDITORIAL VIEWS ... ..	597
RECTIFIED A.C. FOR H.T. SUPPLY ... .. By F. H. Haynes.	598
REACTION ... ..	602
By R. D. Bangay.	
READERS' NOVELTIES ... ..	605
WIRELESS IN COALMINES ... ..	607
CURRENT TOPICS ... ..	610
SOCIETIES FIELD DAY ... ..	612
NEW APPARATUS ... ..	614
NEWS FROM THE CLUBS ... ..	616
NOTES ON SHORT WAVE RECEPTION ... .. By S. K. Lewer.	617
BROADCASTING IN SPAIN ... ..	621
TESTS ON REFILAMENTED VALVES ... ..	622
BROADCAST BREVITIES ... ..	623
RECENT INVENTIONS ... ..	625
LETTERS TO THE EDITOR ... ..	626
READERS' PROBLEMS ... ..	627

materials and components, because it is almost impossible to test them at the time of purchasing.

We believe that in most cases the effect will be to place the products of the British manufacturer on a pedestal of superiority over most of his competitors, and this confidence on the part of the British manufacturer is no doubt the reason why he has shown such strong approval of the principle of standardisation.

# Rectified A.C. for H.T. Supply

For Operating a Multi-Valve Receiver, Small Transmitter, or H.T. Battery Charging.

By F. H. HAYNES.

POWER amplifying valves, and the use of multi-valve receivers generally, demand such a heavy high-tension current supply that the maximum current output of dry cell batteries is scarcely adequate for the purpose. A four-valve set comprising a high-frequency amplifier, valve detector, and two low-frequency valves may, at times, require a total plate energy approaching that normally used for the average 10 watt transmitting station, and bearing in mind that a receiver is in operation for much longer periods than the transmitting set, it has become necessary to consider the problem of obtaining the high-tension current from some other source than dry cell batteries. With the increasing adoption of resistance amplification requiring, as it does, high plate potentials and dissipating energy across the anode resistances, the trend in amateur development is to devise means for deriving the plate current from public supply mains.

Where a direct current supply is available, the amateur invariably bridges the mains with a resistance in the

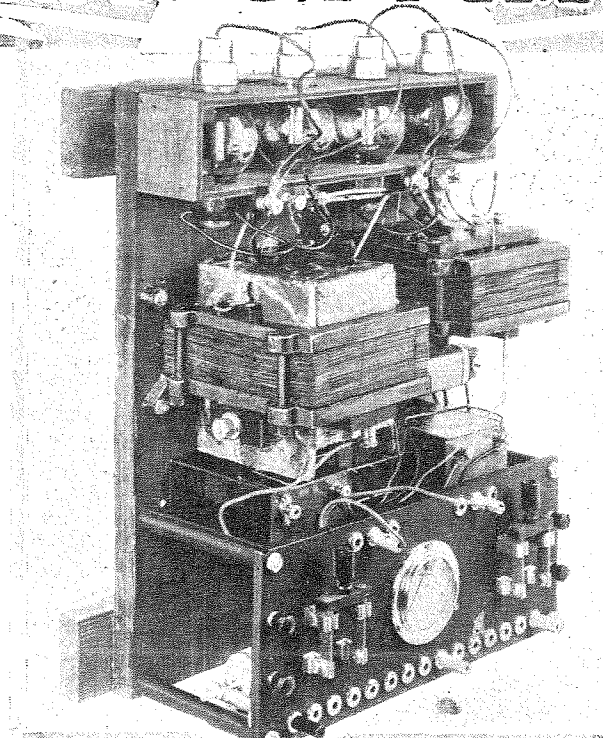

Completed rectifier for supplying the H.T. for a multi-valve receiver, a transmitter, or for H.T. accumulator charging, arranged for wall mounting.

An entirely new development. The first published description of an instrument for successfully deriving receiver plate current from 50 cycle public supply mains.

form of spools of resistance wire or several lamps series connected stepping off suitable voltages in potentiometer fashion. If commutator ripple is found to be present, superimposing a hum on the received signals, a smoothing circuit consisting of chokes and large reservoir condensers may be adopted. It is often, however, very difficult to entirely remove D.C. hum which fluctuates in frequency and intensity, and the trouble is best overcome by using high-tension accumulators, charging them occasionally through a lamp resistance.

### Suitability of A.C. Supply.

Until recently the writer regarded himself as fortunate in having D.C. supply, and for several years used the arrangements just referred to, with complete success, never having occasion to purchase a dry cell battery. On making a change, he regretfully looked forward to the so-called disadvantages of an A.C. supply so generally deemed an unsuitable source of H.T. for reception or

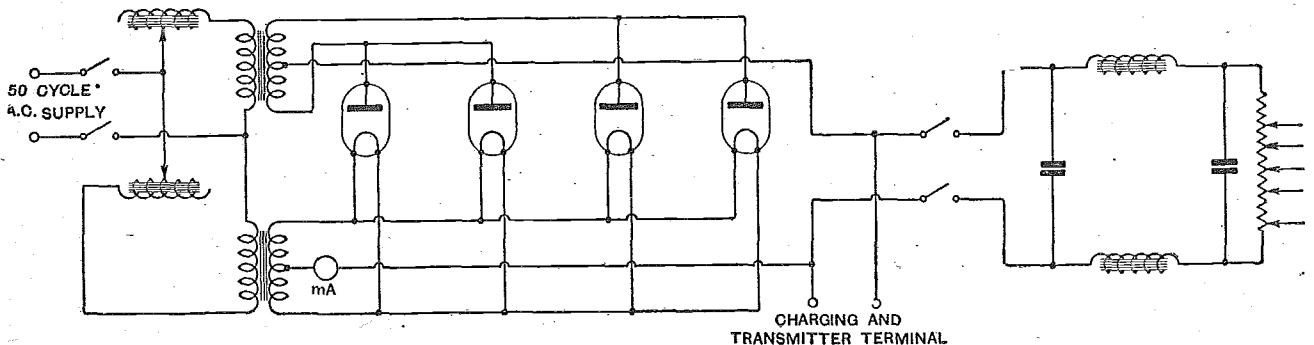

Full wave rectifier, smoothing circuit and potentiometer.

**Rectified A.C. for H.T. Supply.—**

transmission. After some experimental work, however, the instrument here described was evolved, and is capable of operating multi-valve receiving sets with entire absence of A.C. hum, ripple being removed more easily than was found possible on the D.C. system.

Referring to the circuit, it will be seen to consist of two transformers deriving primary current from the mains, one stepping down to a potential suitable for applying to the filaments of rectifying valves, and the other producing a voltage increase which, after rectification and smoothing, is applied to a potentiometer for obtaining a wide potential range. The variable chokes in the primary circuits control the potentials developed across the secondary terminals. Full wave rectification is arranged for, and although each valve (Mullard U.3) is capable of delivering 150 milliamperes, and all four, as regards output, are virtually in parallel, it was found that a much smoother rectified current was obtained by the use of two parallel connected valves instead of one in each limb of the transformer. This is due to the comparatively low resistance of the potentiometer, which is shunted across the rectified current terminals, creating a comparatively heavy load, and if only one small valve is used for each half-cycle the wave form of the rectified current will not permit of easy smoothing. The potentiometer has a resistance as low as 6,300 ohms, which, although being very wasteful, is essential when stepping off various voltages for the several valves of a receiver, so that the connecting up of low impedance valve circuits, such as the second stage of a power amplifier, will not influence the potentials already tapped off the other valves. By the use of the four valves large currents are obtainable, suitable, if required, for changing a high-tension accumulator battery, and a current as heavy as 0.35 ampere is easily produced across the terminals of a 300 volt. battery. The battery charging terminals are, of course, available for operating a transmitter of moderate power. High voltages can be derived with the small current output of, say, a maximum of 60 milliamperes, which, being only a small load, results in high rectification efficiency, and an easily smoothable plate current.

In design, the apparatus is laid out on a baseboard

owing to its large and heavy components, with a control panel covering the smoothing circuit. Practically no suitable components are obtainable on the amateur market, and as a result the step-up and step-down transformers, primary chokes, smoothing chokes, and the output potentiometer must be home-constructed. The transformers, unless specially made up to the reader's requirements (Zenith Manufacturing Co., 92a, Villiers

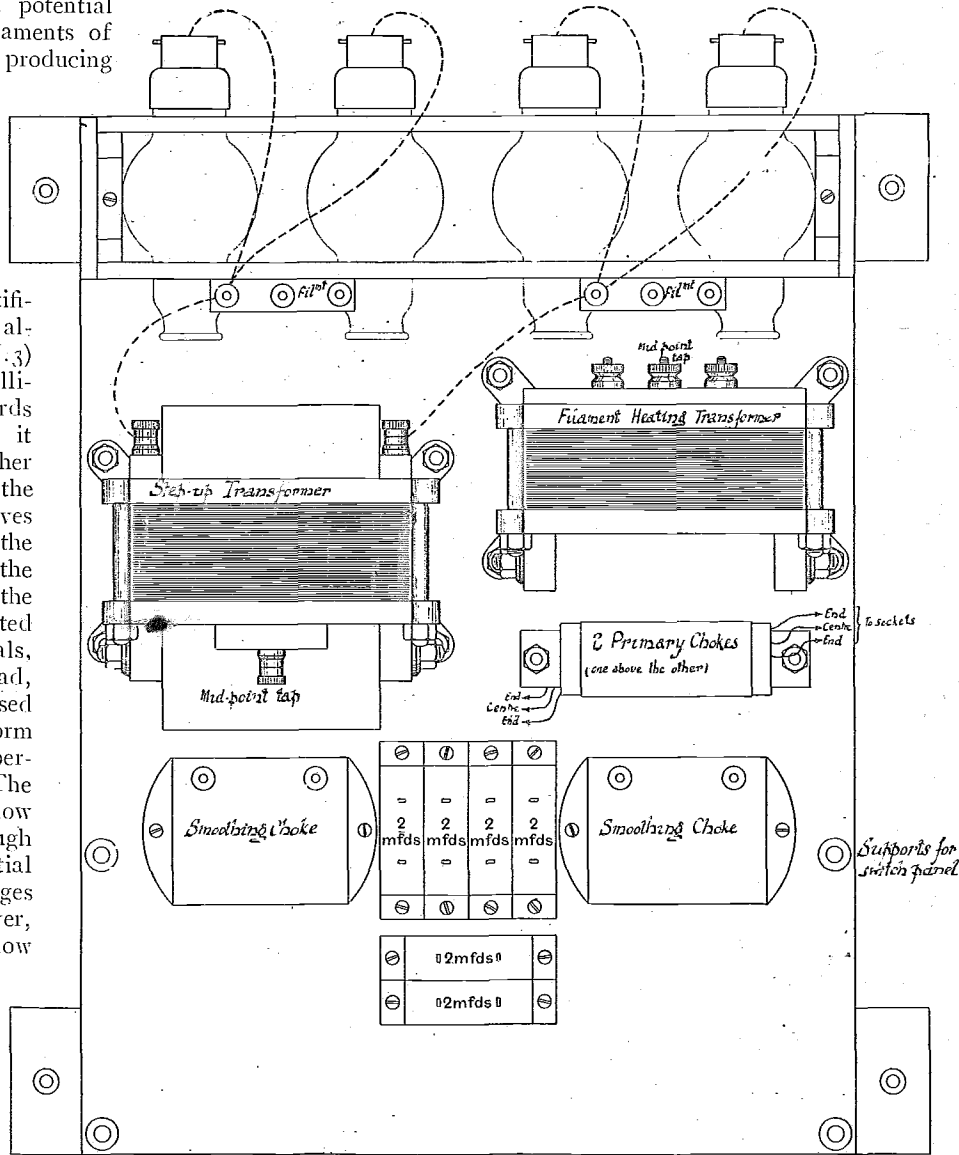

General arrangement for the components on the baseboard, which measures 12in. x 16in. x 5/16in. Ample space is available for accommodating smoothing equipment consisting of larger components than those shown.

Road, London, N.W.2), are best constructed by making use of the core, and one secondary winding of ex-Government transformers bearing the name plates of the Wilson Apparatus Co. or Indo-European Telegraph Co., and rated at 1.5 kW. at 300 cycles. The transformers are completely dismantled and the strip primary wire removed. For a 240 volt. 50 cycle supply, new primary windings are substituted, consisting of 8 layers of 175 turns per layer of No. 30 S.S.C., or, better still,

**Rectified A.C. for H.T. Supply.**—  
enamelled single silk covered. These primaries are used in conjunction with chokes, equal in length to the cores,  $1\frac{1}{4}$  in.  $\times$  in. in cross section, wound with a corresponding number of turns, and with a tapping point at the fourth

Should the reader decide to build his own transformers, procuring suitable stampings (Joseph Sankey & Sons, Ltd., 168, Regent Street, W.1), he must bear in mind that a secondary output of about 90 watts is required of each transformer. This allows liberal margin, of course, and reduction in the actual outputs is controlled by the two tapped chokes. The valves need a potential of 5.5 volts at 2.2 amperes, though to provide for losses a voltage of 7.5 might be aimed at with an available current of 12 amperes. With a primary potential of 240 volts, the current will be about 0.4 ampere, and calculated at 1,000 amperes per square inch, the necessary wire gauge for the primary would be about No. 24 S.W.G. No. 26, however, will be found suitable. In small power transformers of less than 100 watts and with

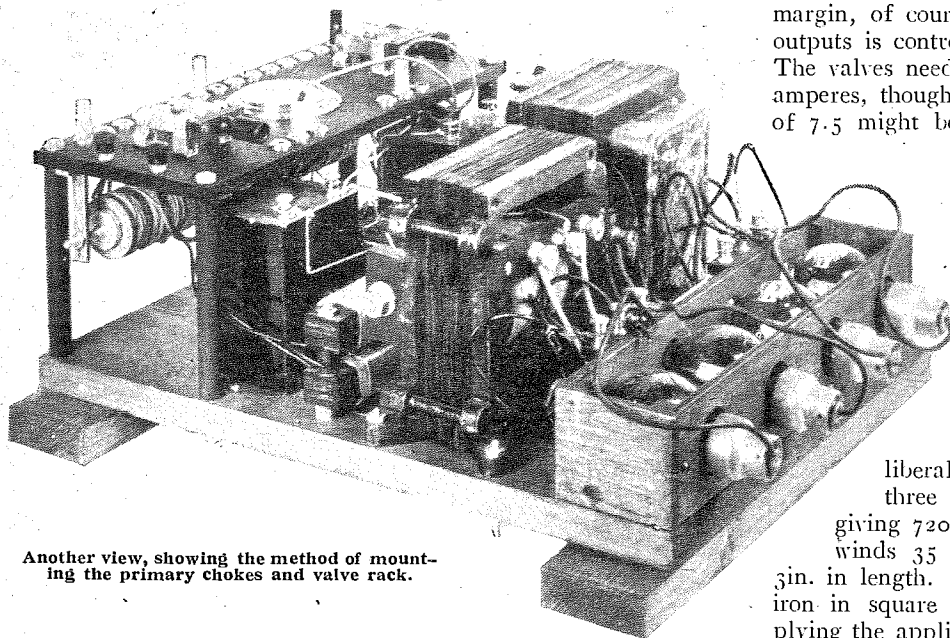

Another view, showing the method of mounting the primary chokes and valve rack.

layer so that the complete choke may be included in circuit, or only half of it, or entirely cut out by means of a plug and three sockets.

**Transformer Design.**

The step-up transformer develops, roughly, 1,800 volts across its secondary terminals, which, when split by the mid-point tap, made by carefully melting out the wax with a hot iron and soldering on a lead, applies, on normal load, 900 volts to the anodes of the rectifiers. It is on this voltage that an output of exactly 100 milliamperes is obtained at a voltage of 650, showing that the valves are being run well within their limits, the rating being 150 milliamps per valve at a potential of 2,000 volts. The normal valve impedance is not stated by the makers, but it is apparent from this that only a small voltage drop takes place across them.

A single layer of 35 turns with mid-point tap is a suitable secondary for filament heating. The stampings are of the double closed core or "shell" type, with the centre core  $1\frac{1}{2}$  in. in diameter, and with a primary winding length of full 3 in., allowing  $\frac{1}{2}$  in. at each end for insulation. The strips of metal which close the magnetic circuit are  $\frac{1}{2}$  in. in width, so that the total length of the centre core is  $4\frac{1}{2}$  in. The transformer is  $5\frac{1}{2}$  in. high and  $1\frac{1}{2}$  in. deep.

liberal core cross section a winding of three turns to the volt is needed, giving 720 turns, which in No. 26 D.C.C. winds 35 turns to the inch, or 7 layers 3 in. in length. The cross sectional area of the iron in square inches is calculated by multiplying the applied voltage by  $10^8$ , and dividing by the product of the number of turns, the frequency, and 4.44 times the maximum flux density which can safely be taken as 40,000. The result of 3.6 square inches is obtained, which, being a liberal figure, may be made up from a rectangular core composed of strips 2 in. wide and to a depth of  $1\frac{1}{2}$  in. The step-down secondary should consist of 34 turns of No. 18 D.C.C. wound as a single layer in the centre of a thin ebonite tube fitting closely over the primary. The step-up secondary, to give a voltage of about 1,800 for division of 900 volts across the two sets of valves, should consist of about 5,500 turns, and a suitable current carrying capacity is provided by using No. 32 S.W.G. With single silk covering this winds about 75 turns to the inch, giving 225 turns to the layer, and the required secondary will be produced by

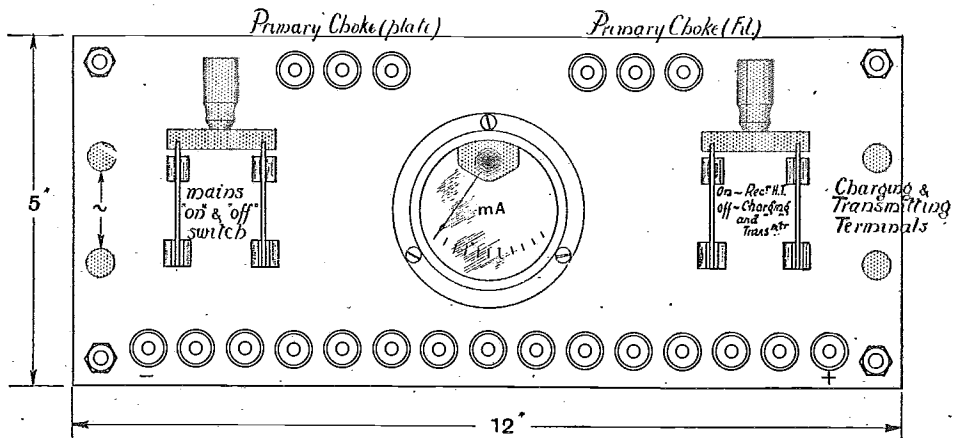

The ebonite switch panel. The upper sockets control the maximum potential developed, and those on the lower edge provide various potentials in convenient steps.

**Rectified A.C. for H.T. Supply.—**

20 layers which, with paper between every layer, may occupy a depth of up to 1 in.

The smoothing chokes have cores built up from "E" shaped stampings, which carry a spool with a winding space  $1\frac{5}{16}$  in. in length,  $\frac{1}{2}$  in. deep, and a total flange diameter of 2 in. Into this space is wound 4,000-4,500 turns of No. 35 enamel covered wire, producing an inductance of roughly 20 henries (Messrs. Rich and Bundy, 13, New Street, Ponders End, Middlesex). Mansbridge type condensers in two banks each to the value of 8 microfarads bridge the choke coils.

Although only having paper as a dielectric, these condensers stand up to the voltage quite satisfactorily, for they are always shunted by the potentiometer, which prevents any excessive rise of potential.

The potentiometer, with a resistance of 6,300 ohms, is wound on to 14 slots,  $\frac{5}{16}$  in. deep on a wooden former

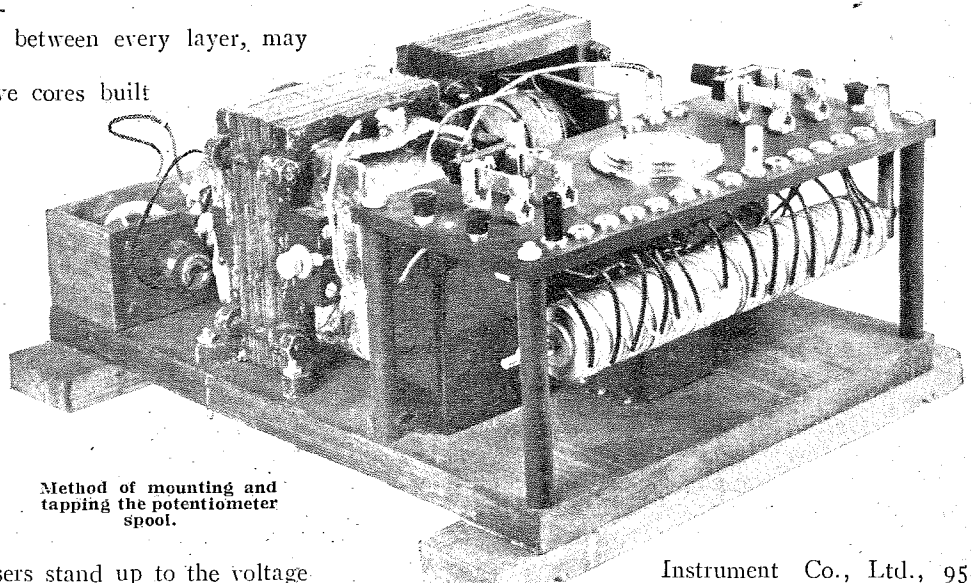

Method of mounting and tapping the potentiometer spool.

Instrument Co., Ltd., 95, Queen Victoria Street, E.C.4)

of 100 m.a., and in operation is near the middle of the scale, when both primary low-frequency chokes are plugged completely in circuit, practically no change occurring in the reading when the plate circuits of a multi-valve receiver are connected up.

The panel itself is supported from the base by means of four ebonite tubes,  $\frac{1}{2}$  in. in diameter, and  $4\frac{1}{2}$  in. in length, purchased with  $\frac{1}{4}$  in. hole. A B.A. threaded rod passing through these ebonite pillars holds the panel firmly in position.

It is, of course, essential to arrange that each positive high-tension terminal is connected to the filament circuit in the receiver through the usual

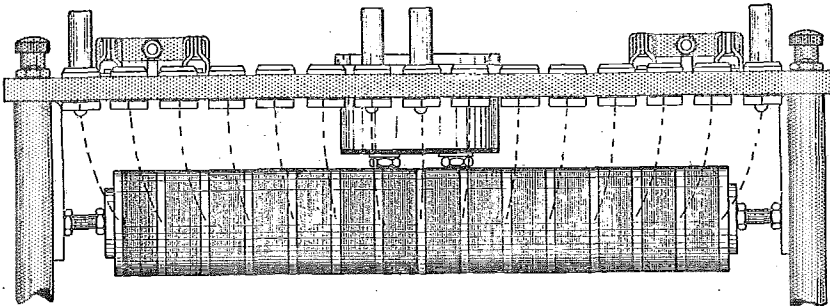

Details for mounting the potentiometer upon a length of brass rod carried on a pair of brass brackets.

$1\frac{1}{2}$  in. in diameter. No. 34 S.S.C. "Eureka" wire is used, having a resistance of 10 ohms to the yard. As under 1 lb. of wire is required, it should be purchased on two  $\frac{1}{2}$ -lb. reels and run on as a pair with the beginning ends joined together to produce a non-inductive winding. By nearly filling each slot, the resistance of approximately 450 ohms per section is obtained.

2-mfd. condensers.

**Assembly.**

Little need be said concerning the practical details of wiring up, except that to prevent induction between A.C. and D.C. circuits all leads should be wrapped with strips of lead foil, particularly those on the control panel. The panel itself is of  $\frac{1}{16}$  in. ebonite, and carries nickel-plated plugs and sockets. Switch movements can be purchased on porcelain bases and remounted. The use of ebonite shrouded terminals is advisable. The meter (Sifam Electrical

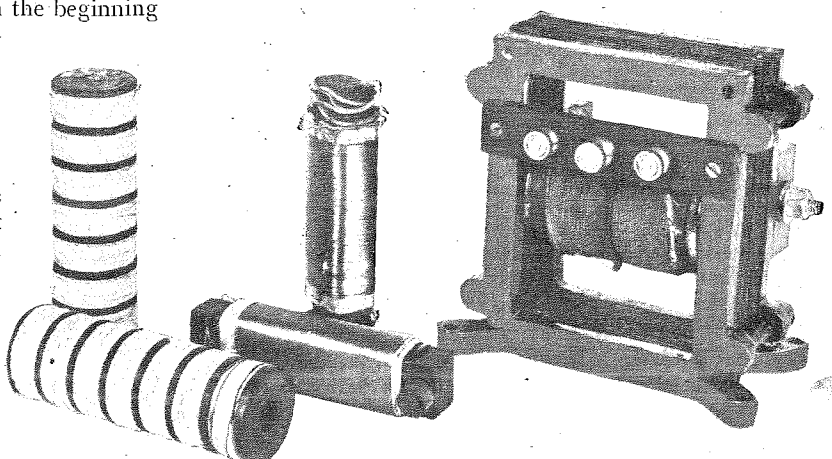

The potentiometer spool, for convenience, may be built in two sections. Primary chokes and filament heating transformer are also shown.

# REACTION.

## The Principles Underlying Reaction Effects.

By R. D. BANGAY.

THE principle underlying "reaction," as it is usually termed, is the utilisation of a small proportion of the energy liberated in the anode circuit by a given electrical effort applied to the grid to boost up or augment the effort in the grid circuit, thereby increasing the effective energy released in the anode circuit by the original effort applied to the grid.

The possibility of making use of this principle depends, of course, upon the magnifying property of the valve, otherwise no advantage could possibly be gained by transferring energy from one circuit to the other. Since, however, the energy released in the anode circuit is many times greater than the energy expended in the grid circuit, it is possible to divert a certain amount of the former from its ordinary channels without appreciable loss of signal strength, and, by adding this diverted energy to the incoming signal oscillations in the grid circuit, we obtain in the anode circuit an effect equal to that which would be produced by a correspondingly stronger signal.

### How is Energy Transferred ?

The first point to examine is how this transfer of energy from the plate circuit to the grid circuit can be arranged for. In order that the oscillatory currents in the grid circuit can obtain any reinforcement from the energy liberated in the anode circuit, the frequency of the oscillations induced in the latter must obviously be the same as the frequency of the signal oscillations; moreover, these oscillations must also be in phase with the signal oscillations, otherwise they may tend to neutralise rather than augment the signal oscillations.

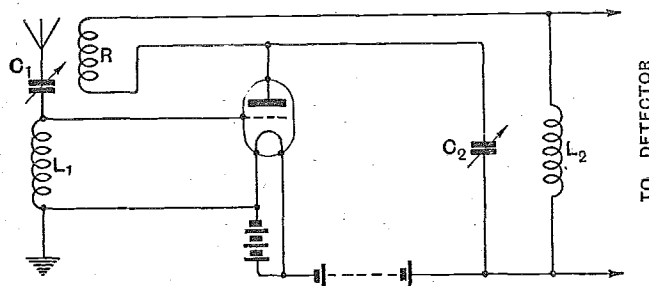

Fig. 1.—A simple "tuned anode" H.F. amplifier.

Now, when the valve is being used as an H.F. magnifier, as, for example, in the circuit illustrated diagrammatically in Fig. 1, which shows a tuned anode circuit, it is quite obvious that the oscillations generated in the anode oscillatory circuit  $C_2 L_2$  will have the same frequency as the signal oscillations because the circuit is being impulsed by the anode current, which is controlled by the grid potential, which in turn is induced by the signal oscillations. If, then, we detach a portion of this anode circuit and couple it magnetically to the aerial circuit, as shown

in Fig. 2, the conditions in the anode circuit will be undisturbed, but now any oscillations induced in that circuit will obviously generate corresponding oscillatory E.M.F.'s in the grid circuit, which have exactly the same frequency as the signal oscillations. Provided, therefore, the E.M.F.'s due to the anode oscillations are in phase with those produced by the signal, they will assist the latter and thus produce the required result.

The correct phase relation can easily be found by experiment, because, by winding the two coils, *i.e.* the aerial coil and the reaction coil in Fig. 2, in any given way, as shown in Fig. 3, we can reverse the phase relation either by reversing the connections to the reaction coil or by moving the reaction coil through half a revolution, thus reversing its position as shown in Fig. 4, or we can wind the two coils in opposite directions, as shown in Fig. 5.

It will be found that the relative directions shown in Figs. 4 and 5 are correct for giving reaction, and that

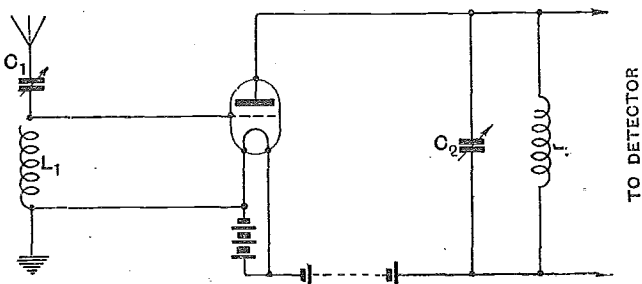
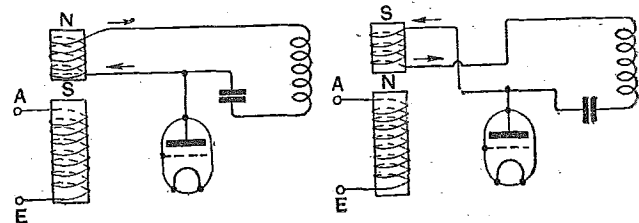

Fig. 2.—The amplifier of Fig. 1 arranged to give reaction effects.

those shown in Fig. 3 will give "anti-reaction." Different degrees of coupling can be obtained by moving the reaction coil nearer to or further away from the aerial coil, or by moving it through a quarter of a revolution.

### Reaction from the Detector.

Exactly similar results can be obtained when the valve is used as a detector, as, for example, in the circuit illustrated in Fig. 5, although in this case it is not quite so obvious why the currents in the anode circuit have the same frequency as the signal oscillations, because the currents passing through the telephones are low-frequency



Figs. 3 & 4.—The effect of reversing the polarity of the reaction coil.



**Reaction.—**

currents resulting from the rectification of the modulated signal.

As explained in a previous article,<sup>1</sup> however, the rectified currents delivered in the anode circuit of a rectifier consist of a series of high-frequency uni-directional impulses corresponding in frequency to that of the incoming signal, and it is only the electrical sluggishness of the telephone windings which integrate these consecutive impulses into an average current varying at low frequency. There is always, therefore, as we explained, a high-frequency component in the current flowing in the rectifier circuit. By providing a low impedance path for this H.F. component through the reaction coil we can obviously obtain the same effect as in the case of the tuned anode circuit.

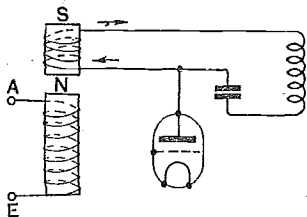

Fig. 5.—The reaction coil shown here is wound in the opposite direction to that of Figs. 3 and 4.

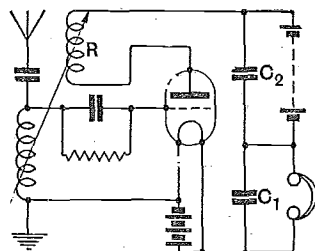

Fig. 6.—A single valve receiver with reaction.

Such an arrangement is shown in Fig. 6, which illustrates the circuits of a simple single valve receiver with reaction.

**Path of the H.F. Currents.**

Remembering that the higher the frequency of the current, the lower the impedance offered by a given capacity, it will be seen that, by connecting the small condenser  $C_1$ , known as the "bye-pass" condenser, across the telephones, we can provide a low impedance path across the telephones for the high-frequency component without interfering with the low-frequency current flowing through the telephones, because to low audio frequencies this condenser will offer a very high impedance. This condenser, however, must be kept small, about 0.0015 mfd. for wavelengths up to 2,000 or 3,000 metres. If it is made much larger than this it will not offer a high enough impedance to the low-frequency telephone currents, which would then tend to flow through the condenser instead of through the telephone windings. The condenser  $C_2$  is connected across the anode battery to allow the H.F. component an easy path across the battery, thereby obviating the internal resistance of the battery. In this case there is no question of shunting the telephone current, and therefore the condenser may have a large capacity. In fact, the larger the capacity of this condenser the better it will then act as a reservoir for feeding the whole of the anode circuit, and to a large extent neutralise the resistance of the battery for the telephone currents as well as for the H.F. component. With this arrangement it will be seen that the high-frequency component will have a perfectly free path from the plate through the reaction

<sup>1</sup> *The Wireless World*, "The Three-Electrode Valve Detector," May 13th, 1925.

coil R, through the condensers  $C_2$  and  $C_1$ , back to the filament.

**Oscillations Induced in Tuned Circuits.**

We may now examine what is the effect of reaction on the incoming signal. The amplitude of the current generated in the anode circuit is, as we know, dependent on the amplitude of the E.M.F. impressed on the grid; also for a given current in the anode circuit the amplitude of the E.M.F. impressed on the grid by the anode circuit will depend upon the coupling between the reaction coil and the grid circuit.

Let us take, first of all, the case when the reaction coupling is reduced to zero, and let us assume, for the sake of simplicity, that the incoming signal consists of a short group of undamped waves, as indicated by the curve A in Fig. 7. The resulting oscillations in the tuned aerial circuit of the receiver are shown by the curve B in Fig. 7, where it will be seen that, due to the effect of resonance, the oscillations gradually build up to a certain maximum during the first four or five cycles of the incoming signal, after which they remain constant for the duration of the signal, because the energy lost per cycle in the resistance of the aerial circuit at that amplitude is equal to the energy gained per cycle from the incoming waves. As soon as the signal ceases the oscillations in the aerial gradually die down owing to the resistance losses in that circuit, which are now no longer made good by the signal. If the losses in the aerial were

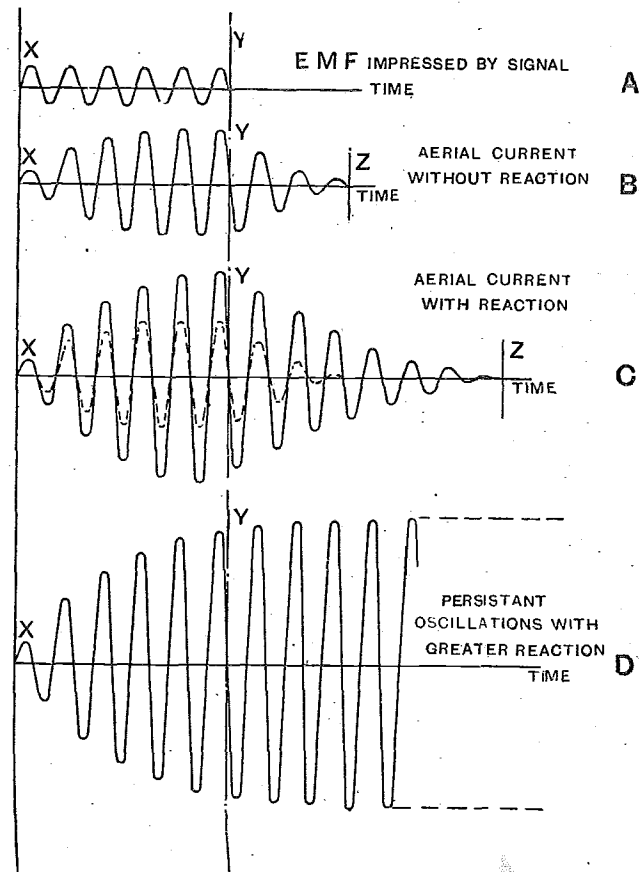

Fig. 7.—The effect of reaction on the oscillations set up by an incoming signal.

**Reaction.—**

less, obviously the signals would build up during a greater number of cycles and to a greater amplitude, and would also take longer to die down. In other words, the "damping" of the circuit would be less than that indicated.

**Effects of Reaction.**

Now let us suppose we introduce a certain amount of reaction by coupling the reaction coil to the aerial circuit. It will be clear that in this case, during the time that the signal is acting on the aerial, the aerial circuit will receive energy both from the signal and from the anode circuit, and, consequently, the oscillations will build up to a greater amplitude (than in the case when there was no reaction) before the energy lost per cycle in the aerial circuit is equal to the total energy received per cycle from the signal and from the anode circuit. Moreover, when the signal ceases, the oscillations will not die down so rapidly as in the case where there was no reaction, because, although the aerial circuit no longer receives energy from the signal to make good the losses in it, it still receives energy from the anode circuit at each cycle, and therefore, unlike the previous case, the energy lost is now partially made good. This is illustrated diagrammatically by the curve C in Fig. 7, where, for the sake of easy comparison, we have also indicated by dotted lines the oscillations shown at B, when there was no reaction. It will be seen from this curve that we have increased both the amplitude and the persistence of the oscillations generated by a given signal in the aerial. In fact, we have accomplished practically the same result as if we had decreased the damping of the circuit, and, therefore, besides increasing the strength of the signal, we have increased the sharpness of tuning.

In the foregoing example, we have assumed that the amount of energy received per cycle by the aerial circuit from the anode circuit, during the dying down period, is less than the energy lost per cycle in the aerial circuit. Suppose, however, we increase the reaction still further until the amount of energy received by the aerial circuit from the anode circuit is sufficient to replace all the energy lost in the aerial circuit. It is not difficult to see that in that case, when the incoming signal ceases, *i.e.* after the moment Y, the aerial oscillations will not die down at all, but will continue to oscillate indefinitely as illustrated by the curve D in Fig. 7. When this condition exists the valve is said to be oscillating.

There is an important point to notice which we have not yet referred to. During the period when the signal is acting on the aerial, *i.e.* during the period XY in the case indicated by the curve B, the oscillations in the anode circuit are controlled entirely by the incoming

signal, and therefore have the same frequency as the signal. But when the signal ceases, obviously the oscillations are no longer controlled by the signal, and therefore during the dying down period, *i.e.* from Y to Z, the circuit will oscillate to its own natural frequency. If the circuit happens to be exactly in tune with the incoming signal, then its natural frequency will be the same as that of the signal, and consequently there will be no change of frequency, but if, on the other hand, it happens to be slightly out of tune, then there will be a correspondingly slight change of frequency immediately the signal ceases. In the cases illustrated by the curves B and C this slight change of frequency is of no particular importance. But in the case when the reaction is increased to the oscillating point, as indicated by the curve D, it will be seen that since the frequency of the oscillations is now controlled

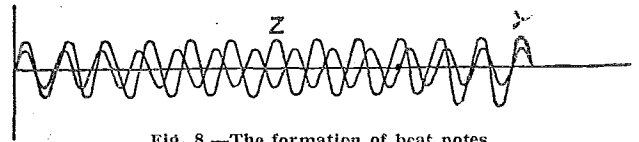

Fig. 8.—The formation of beat notes.

entirely by the natural frequency of the oscillatory circuit, if the tuning of the oscillatory circuit is varied the frequency of the oscillations will be adjusted accordingly. Suppose, therefore, the circuits happen to be slightly out of tune with the incoming signal, the result will be that the phase relation between the incoming signal and the anode oscillations, instead of being always in phase, will continually vary, as shown diagrammatically in Fig. 8, where at the moment X they are in phase and at the moment Z they are in antiphase. Thus the oscillations due to reaction will at one instant add themselves to the signal oscillations, causing an increase in the resulting telephone current, and at the next instant they will tend to neutralise the signal oscillations, causing a decrease in the resulting telephone current.

The frequency at which this increase and decrease take place depends obviously upon the difference between the frequencies of the two sets of oscillations, and therefore, if the signal frequency remains constant, depends upon the adjustment of the oscillatory circuits. When the difference between the two sets of oscillations comes within the audible scale of frequencies it produces a musical note in the telephones, which varies in pitch as the tuning of the circuits is altered. This note will drown any sound modulations in the received signal, and therefore make the reception of telephone signals impossible. Unfortunately, it also interferes with neighbouring receivers, because the oscillations generated in the aerial circuit are radiated by the aerial.



THE COFFEE STALL DE LUXE.  
Refreshments to broadcast accompaniment.

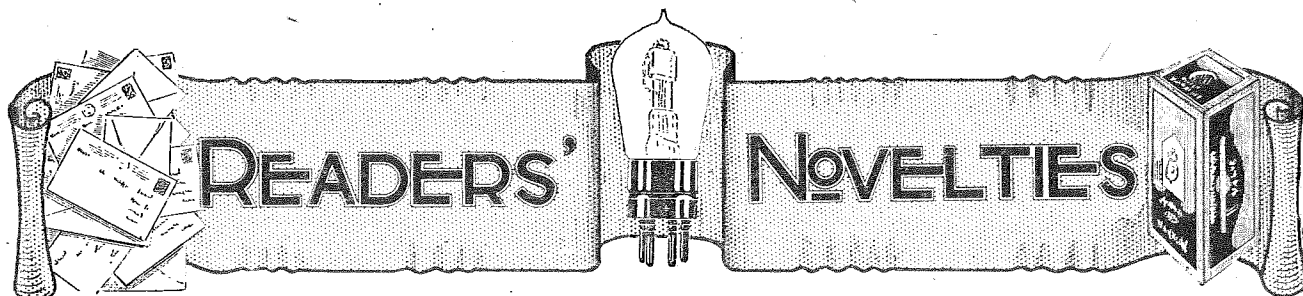

A Section Devoted to New Ideas and Practical Devices.

**AN EFFICIENT EARTH PLATE.**

The necessity of making a soldered joint between the earth lead and earth plate may be obviated by the following method.

A strip about 2 inches wide and long enough to reach to the surface of the ground is cut along one edge of the plate. A wooden stake of suitable length is then driven into the ground at the side of the hole previously prepared for the earth plate. The strip is then bent vertical and secured to the stake with copper binding wire. A terminal is screwed into the wood through the top of the strip, to which the earth lead may be attached.

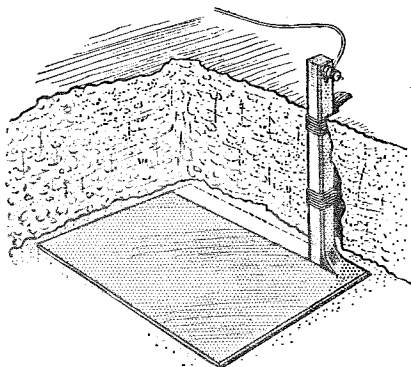

An earth plate connection which eliminates soldered joints.

If trouble should develop in the earth system it is certain to be located above ground, and it is not necessary to unearth the plate to examine joints below the ground level.—C. C. B. H.

**AN EMERGENCY CRYSTAL SET.**

This attachment was constructed with the object of providing some means of hearing the conclusion of an important transmission in the event of the failure of the valve set, say, through accumulator running down.

The crystal detector and a pair of

terminals are fixed to the upper side of an ebonite panel of suitable dimensions. To the under side of the

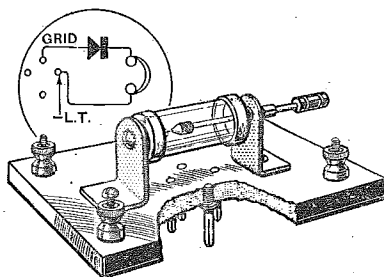

Emergency detector unit for use in valve receivers.

panel are screwed four valve pins arranged in the usual manner. The crystal detector and the telephone terminals are connected in series across the grid and —L.T. valve pins.

The unit is plugged into the first valveholder in the set, when it will be seen that the crystal and telephones are connected across the A.T.I. If the first valve is a detector it may be advisable to remove the grid leak and short circuit the grid condenser.—C. F.

o o o o

**WINDING DUO-LATERAL COILS.**

Coils wound with silk- or cotton-covered wire are generally treated with paraffin wax or shellac varnish with the object of excluding moisture from the absorbent covering and increasing the mechanical strength of the finished coil. It is customary to wind the coil first and then to immerse it in a bath of wax or varnish, finally shaking out any excess of liquid that may be lodged between the turns. While this shaking certainly removes much of the liquid, it cannot dislodge that which clings by capillary attraction to the points where wires cross, say, in a duo-lateral coil. It is at these points

where the presence of a solid dielectric is most likely to increase the self-capacity of a coil, and any method which will prevent an excess of varnish from collecting here would greatly improve the quality of the finished coil.

It is a very good plan to pass the wire through a bath of the insulating liquid as it passes from the spool to the winding machine. Any excess of liquid is wiped off by the felt pads at the outgoing end of the bath, just sufficient being retained in the absorbent covering to make the turns of wire adhere to each other.

The bath has a very useful application in connection with the winding of duolateral coils on the special machines sold for the purpose by

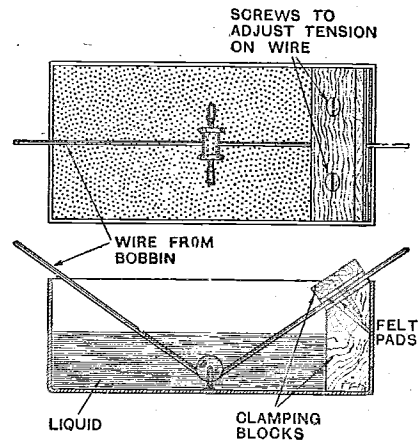

Bath for treating cotton and silk-covered wires.

several well-known firms. There is often difficulty in winding with very fine wire owing to the fact that the lower portions of the coil collapse under the pressure of the upper layers. A certain amount of tension is essential if the wave form of the winding is to be maintained, and it happens that the tension which will just ensure correct winding is also

just sufficient to cause the coil to collapse. The obvious remedy is to strengthen the lower layers by binding the turns together with wax or varnish before the upper layers are completed. This can be carried out with complete success by passing the wire through a bath of hot paraffin wax. The copper wire retains the heat it acquired while passing through the bath, and thus keeps the wax soft until the wire has passed on to the coil. By the time the upper layers are reached, those at the bottom of the coil have cooled and set quite firmly, and a perfect coil results. The rate of cooling should be regulated according to the temperature of the bath by varying the distance between the bath and the winding machine. If a metal arm is employed in the winder to guide the wire on to the coil, this should be warmed slightly, otherwise it will conduct the heat away from the wire before it reaches the coil. The appearance of shavings of paraffin wax at the point where the wire passes over the arm may be taken as an indication that the arm is too cold.—A. P. H.

o o o o

#### A FORMER FOR LOW LOSS COILS.

A very efficient tuning coil for short wavelengths can be wound on the former illustrated in the diagram. Two pieces of hardwood or three-ply wood are cut to the dimensions given, and fitted together to form a frame. The central slot should be reversed in one of the members in order that the winding slots in both arms may open on the same side. Bare or enamel-covered copper wire should be used for the winding, and where the wire passes through a slot a short length

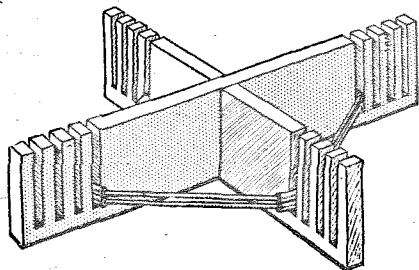

Efficient air-spaced coil.

of systoflex is used to space the turns. If the coil contains a large amount of wire, it is convenient to split open the systoflex in order to fit it on to

A 16

the wire; for small coils the systoflex lengths may be slipped over the end of the wire. The winding is commenced in the slot nearest the centre of the former, and each slot should hold a single layer of turns.—B. H.

o o o o

#### COIL HOLDERS WITH SLOW MOTION.

The coil holder mounting illustrated in the diagram is not difficult to make, and, while giving a micrometer control of the movement of the coil, does not involve the use of gear wheels.

The hand lever is pivoted at C to one of the coil holder brackets, and carries a terminal A which is fitted

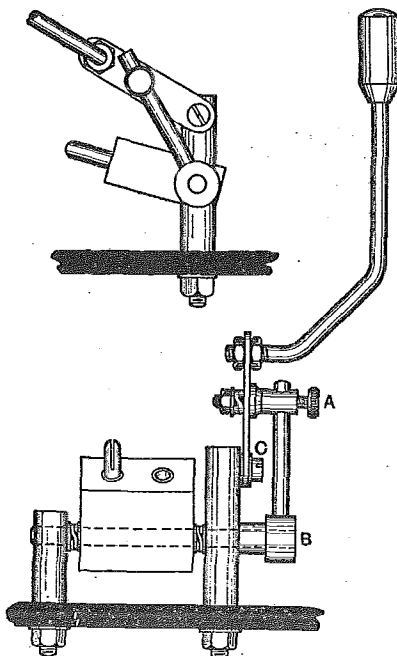

An easily constructed device for producing critical adjustment to a moving coil.

with a spring washer and is free to rotate. Through the centre hole in this terminal passes a rod which is fixed to the coil holder-spindle by the collar B. The parts are so proportioned that the distance AC is equal to the distance BC. Under these conditions it can easily be shown that the angular movement of the coil holder is exactly half that of the hand lever.

The coil can be securely locked in any desired position by tightening the terminal A.—G. C.

o o o o

#### MOUNTING CRYSTALS.

When making comparative tests of crystals, it is convenient to have some

method of rapidly changing the crystals. It is very difficult to compare signal strengths if much time is occupied in changing the crystals.

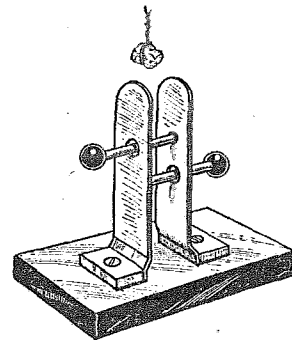

Spring mounting for testing crystals.

Two strips of hard brass or phosphor-bronze are bent at right angles to form brackets which are subsequently screwed to a base board. Holes are drilled in each spring through which pass short lengths of stiff brass wire fitted at the ends with knobs of some insulating material. By pressing on these knobs, the crystal is quickly released.

Contamination of the surface of the crystals through continual handling is avoided if a short piece of copper wire is twisted round each crystal.—P. J. P.

o o o o

#### DRILLING GLASS.

Having tried several methods of drilling glass with the object of finding a suitable method of fixing a lead-in insulator in a window pane, the writer found that the following was superior to those involving the application of heat.

A tube of soft copper or brass is chosen with an external diameter equal to the diameter of the hole required. The tube is mounted in a drill brace and applied to the window pane through a flat piece of wood registered against the window frame and drilled to take the tube. The end of the tube is smeared periodically with Richford's coarse grinding compound which acts as the cutting medium.

Unless the window pane is supported at the back the pressure applied must not be very great, and the process will be rather slow. The result obtained, however, is well worth the trouble taken, and radial cracks are not likely to develop as in other methods.—R. W. H.

# WIRELESS in COALMINES

## An Application of Radio to Life-saving in Mines.



IT has frequently been asserted by writers in the Press that by far the most important aspect of wireless lies in its application to life-saving at sea, and that such usages as the broadcasting of speech and music, and even the transmission of important commercial messages are of only secondary importance when compared with the first-named function. That this is universally recognised to be so is amply demonstrated by the fact that, by international agreement, distress messages from ships at sea assume priority, not only over commercial traffic, but also over the most important naval and military traffic of the ether. Upon the first intimation of a message of distress all stations are required to cease transmitting immediately, no matter how important the messages they may be transmitting, under very heavy penalties for non-compliance.

Twenty years or so ago radiating and receiving messages of distress was the only really practical usage to which wireless could be put, since the science was not then sufficiently developed to be of any real value in handling commercial traffic.

Although the march of progress has completely changed all this, and wireless is to-day one of the most useful and adaptable methods of communication known to man, yet the supreme importance and right of way of the S.O.S. call remain unassailed. This is as it should be, of course; but the general public still seem to have the idea firmly rooted in their minds that the only ways in which wireless can be applied to life-saving is in the establishment of communication with distressed travellers of the sea, and latterly of the air.

### A New Application of Wireless.

There is, however, another class of the general community who, in moments of unforeseen disaster, are as completely cut off from their fellowmen as were formerly the passengers and crews of vessels who, by reason of tempest or other emergency, were in danger of destruction. It is to this class of the community that wireless comes once more as a boon and a blessing, enabling lives to be saved which, before the advent of this comparatively new application of wireless, were doomed to almost certain death. This class of the community, to whom wireless now means so much, is the great army of workers in the world's coalmines. Anyone who is a diligent student of the daily Press will, time and again, have read reports of explosions in coal mines in which parties

of men, working at considerable distances from the mine-shaft, were completely cut off from any means of egress by the collapse of portions of the mine workings.

Strenuous efforts are immediately made to reach the entombed men by digging operations, but these operations are hampered by the fact that no communication, except in rare circumstances, can be established with those who have been so suddenly cut off from the outer world, and consequently much time is usually wasted in futile digging in the wrong direction, and frequently when the men are eventually located it is too late. Had there been in the past some reliable method of communication, much time could have been saved by the rescuing party, since they would have been enabled to concentrate their efforts in the right direction, and so have reached the sufferers in time. Another important point is that the knowledge that communication could be had with the outer world and the surety that help was coming would have served to fortify the *moral* of the imprisoned men sufficiently to hold out until the rescue was completed.

Nothing saps the *moral* of a man so quickly as complete darkness and complete isolation, and in this respect even one way of communication from the surface to the men would in the past have been of immense value in sustaining this *moral*.

### "Wired Wireless": a Practical Solution.

Many attempts were made to employ the ordinary wired telephone, and in some cases this was successful, but it was actually very much of a broken reed, since the force of the explosion usually caused a breakage or a short-circuit of the wires in exactly that portion of the mine where its need was greatest.

The difficulty has, however, been overcome by a special application of radio science which has come to be popu-

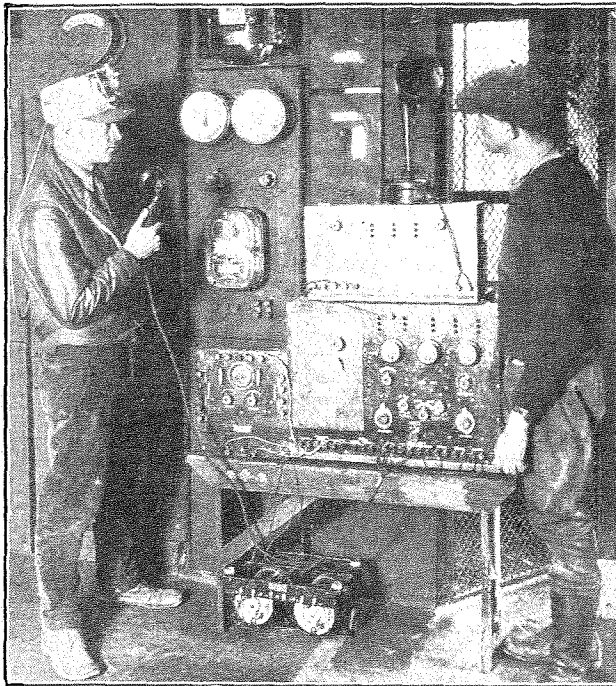

Telephoning from the surface to the mine shaft.

larly known under the name of "wired wireless." In this method of wireless the radio waves are not broadcast through the ether in the ordinary manner, but are made to follow cables or other metallic lines to their destination. They are, in fact, concentrated along these lines, and do not spread out broadcast in the ordinary manner. As is well known, there are various metallic conductors running throughout mine galleries, such as the metals of the trolley cars, the actual trolley wires themselves, compressed air pipes, and other metallic conductors, any and all of which can, in moments of emergency, be pressed into the service of "wired wireless."

#### Vulnerability of Ordinary Telephony Systems.

Now, although ordinary telephone wires are easily broken, it is extremely unlikely that the explosion would completely destroy all these metal conductors which we have mentioned, and, provided that any of them remains, it forms a convenient path for the radiations of the "wired wireless" transmitter. Even though the mine-shafts be completely blocked, it will nearly always be found that a complete metallic path through the mine shafting still exists up to the surface, twisted and contorted though it may be. It has been found in actual experiment by the U.S. and French Governments, who are very much to the fore in this respect, that this system has a very large chance indeed of remaining intact after a violent explosion with its attendant caves-in of the galleries and passages of the mine.

Of course, the question will at once be asked: "Why *wired* wireless?" Why not employ ordinary wireless, and so eliminate the still remaining very slight risk that all the metallic conductors might be destroyed? The answer is that it is all a question of power. In order to

transmit with reliability even a short distance through solid earth and rock would require a transmitter of considerable power, and this would mean bulky and complicated instruments. The disadvantage of bulk is obvious, apart from the fact that bulky instruments would run a greater risk of destruction by the explosion, and there is also the question of complicated operation, since it must not be forgotten that in moments of emergency the installation is to be operated by men without technical or operating skill of any description.

"Wired wireless" has been found to be far the simplest and most reliable system of communication in mines. In tests recently made in America by the U.S. Bureau of Mines, no difficulty was experienced at all in receiving messages from a transmitting apparatus mounted on one of the electric mine locomotives, so long as the latter was in the vicinity of metallic carriers, although a depth of over 400ft. was reached. This system of wireless increases the range of a set to such an extent that a very small, compact, and simply operated low-power telephony transmitter can be used.

#### Simplicity of New System.

Another important fact to note is that the installation of this "line-radio" is extremely simple—much more so, in fact, than the installation of the present wired telephone system of many mines. The basic principle is to lay a wire about 20ft. in length along the ground, or to stretch it along a wall or roof, approximately parallel with some metallic carrier, or to couple the set to the actual metal carriers themselves through the intermediary of proper capacities and inductances. The actual ap-

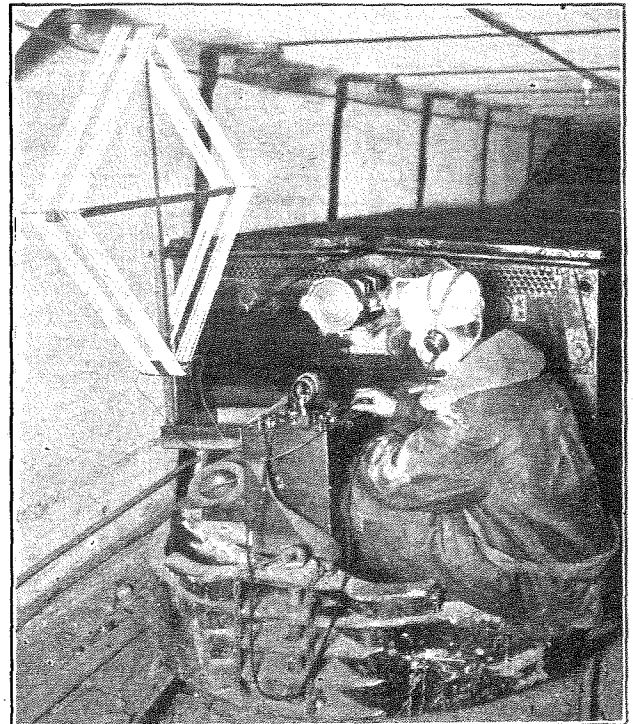

Experimental receiving set mounted on an electric locomotive down in the mine.

**Wireless in Coalmines.—**

paratus of the "line-radio" apparatus is, of course, more complicated than that associated with the ordinary telephone, and its initial cost and upkeep will be somewhat higher also, but this will be amply compensated for by the elimination of the ordinary line telephone, since the installation can be used for communications in the mine under ordinary normal conditions. The elimination of the telephone wires will also do away with the risk of interruption of communication, even under normal circumstances, due to the crossing of frayed wire, with consequent short-circuiting troubles, which has been found to be prevalent enough under ordinary working conditions, quite apart from any consideration of explosions and kindred catastrophes; also space hitherto allowed for telephone wires can be done away with, both in the interior and at the mouth of the mine.

The men in the mine would soon become accustomed to operating the radio sets, which are quite simple to manipulate. There would, of course, have to be a regular service for the care of the apparatus and frequent inspections, but this would be a trivial matter when compared with the importance of the benefits obtained. A further advantage which "line-radio" has over the ordinary system is in its portability, since it could be instantaneously brought into operation in small temporary

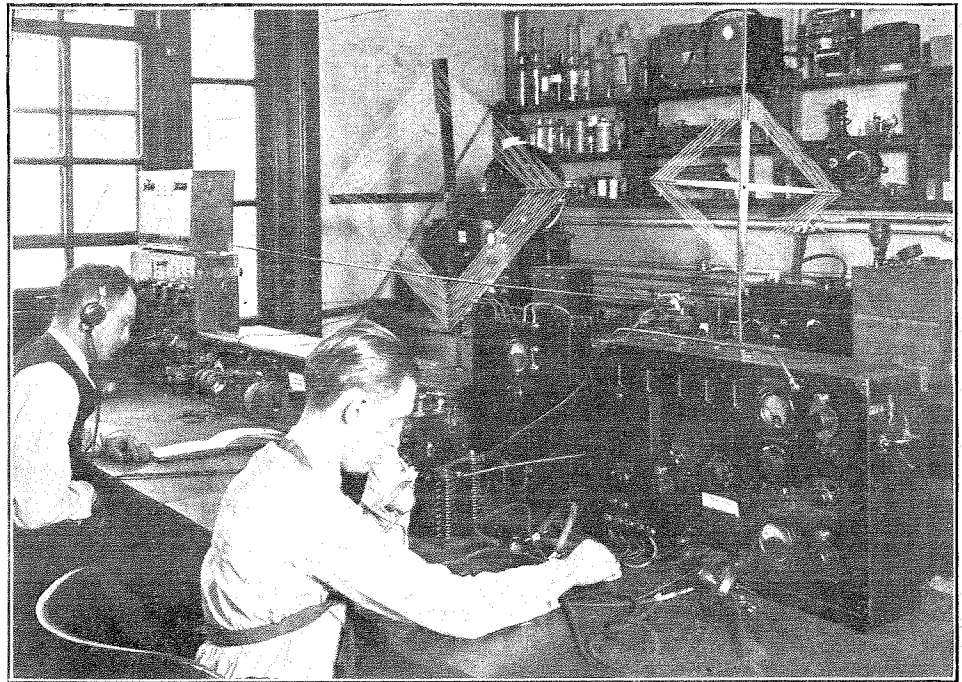

The wireless station associated with the mine.

shafts or galleries without the necessity of laying down any wiring system.

The use of radio in mines in the manner we have discussed will undoubtedly in the near future rank only second in importance to that assumed by ordinary wireless in establishing contact between ship and shore. In this country it has even been seriously discussed as to whether or not it would be an advantage to make it compulsory for each miner to carry his own radio set, and it seems to be abundantly clear that eventually radio apparatus will be as much a part of a mine's equipment as now are blasting powder, picks and shovels.

## BROADCASTING IN BELGIUM.

AT present Belgium only possesses one broadcasting station, namely, that at Brussels, which transmits daily on a wavelength of 265 metres with an input of  $1\frac{1}{2}$  kilowatts. The station is owned by a private company working under a Government concession on similar lines to the B.B.C., income being derived from the sale of receiving licences, which are obtainable through the Post Office. These licences cost 20 francs per annum, or about 4s. 3d. at the present rate of exchange. There are no limitations as to the length of aerials, the only restriction imposed being a law prohibiting their erection over public thoroughfares.

The question of building another broadcasting station has recently been raised by one of the leading journals, "le Soir," but so far there has been no outcome. In the meantime full advantage is being taken of the programmes provided by the high-powered stations of neighbouring countries, Chelmsford and Paris being especially popular.

The Government does not grant licences to amateurs for transmitting, but it would appear that in spite of this a certain amount of experimental work is carried out on the quiet. The interests of amateurs is looked after by the Radio Club Belge, which has branches in all the principal towns. It is hoped that before long this organisation will be instrumental in persuading the Government to grant licences to amateurs for transmission. So far the popularity of broadcasting is confined to the towns.

The Belgians are enthusiastic in their appreciation of goods made in this country, but owing to the adverse rate of exchange the price is prohibitive, the cost of the British-made article being approximately three times that of the French or Belgian. For example, one can purchase a general purpose bright emitter valve for 18 francs (*i.e.*, about 3s. 9d.) and a dull emitter for 25 francs (*i.e.*, about 5s. 3d.). One word of warning to the bargain seeker. There is a tax on valves taken out of the country.

D. A. S. W.

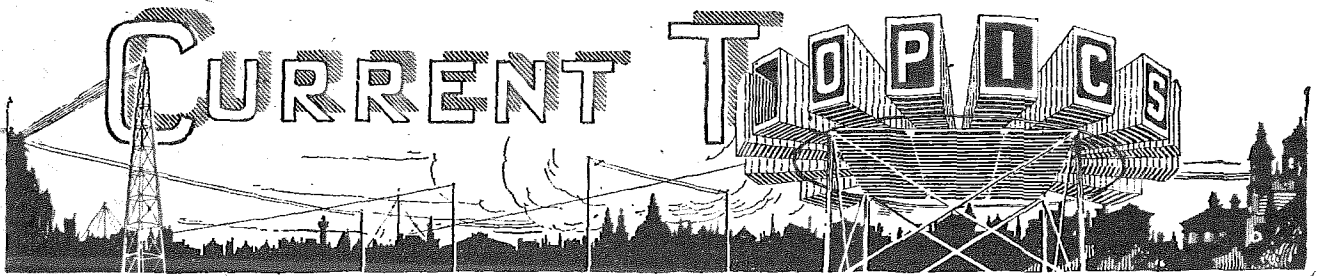

## Events of the Week in Brief Review.

### GREEK WIRELESS CONCESSION.

Amateur reception, with limitations, is now permitted in Greece, according to a recent decree. One of the clauses restricts reception to wavelengths below 2,000 metres.

○○○○

### GERMAN OPERA SINGERS AND BROADCASTING.

It has been decided by the German Appeal Court that when an opera is broadcast the singers are entitled to demand a 10 per cent. increase in salary.

○○○○

### NEW SWEDISH D.F. STATION.

The Swedish Telegraph Administration announces the opening of the direction finding station at Morup on June 15th.

○○○○

### FREE WIRELESS COURSE IN FRANCE.

A free public course in wireless telegraphy and telephony is being given in Paris by the Conservatoire National des Arts et Métiers. The course covers both theory and practice, and includes lessons in wireless direction finding.

### NEW METAL FOR WIRELESS VALVES.

According to a Copenhagen message, Professor Niels Bohr has succeeded in producing the elementary substance hafnium, discovered by him in 1923, in metal form, but only two grammes have as yet been produced. A cheap method of production is being sought so that it may be possible to use hafnium in the manufacture of wireless valves.

○○○○

### TWENTY-METRE RECEPTION IN CHINA.

As we go to press we learn that signals on 20 metres transmitted by the Metropolitan Vickers Experimental Station G2AC at Trafford Park have been picked up by an amateur, Mr. J. Rocka Saraiva, of Macao, near Hong Kong. Signals were received loud and clear on May 8th.

○○○○

### WIRELESS AND THE R.A.F.

At the Royal Air Force pageant at Hendon on June 27th, it is possible that H.M. the King will give wireless telephone orders to aeroplanes in flight.

### NORWEGIAN WIRELESS EXHIBITION.

An exhibition of wireless apparatus is to be held at Oslo from September 1st to 15th, under the auspices of the Radio Goods Dealers' Association and the Norwegian Radio Union. Amateur apparatus will be included in the display.

○○○○

### SPURIOUS CONDENSER MARKINGS.

A warning that the capacity markings on certain of their fixed condensers are being tampered with is issued by Messrs. The Dubilier Condenser Co., Ltd. The Company cites a recent case in which one of their condensers was received for test, having been stamped 0.0003 mfd., but obviously not of their marking. On test this condenser proved to have a capacity of 0.005 mfd.

○○○○

### AERIALS AND PUBLIC HEALTH.

An important provision in the Public Health Act was passed on Thursday last by a Standing Committee of the House of Lords. It provides that local authorities may make bye-laws—

"For the prevention of danger or ob



By courtesy of Marconi's Wireless Telegraph Co., Ltd.

**THE NEW 2LO.** A close-up photograph of the 12-kilowatt transmitter. Seen from left to right, there are two rectifier panels, one independent drive panel (in the centre), one main oscillator, and two modulator panels.



struction to persons using any street or public place from posts, wires, tubes, aerials, or any other apparatus in connection with or for the purposes of wireless telegraphy or telephony installations, stretched or placed, whether before or after the commencement of this section, on or over any premises, and liable to fall on to any street."

"Public place" is intended to include any park or garden to which the public have access, with or without payment.

o o o o

**CALL SIGN WITH TWO OWNERS ?**

Mr. J. F. Fish (2IN) of Blackpool, welcomes information regarding an unknown transmitter who is making use of his call sign. Two Belgian amateurs report reception of 2IN when the station was not working.

o o o o

**ITALIAN DX WITH NEW ZEALAND.**

Two-way communication was established between 1RG, the well-known station of Il Radiogiornale, Milan, and New Zealand 4AK on May 31st, between 5.40 and 7 a.m. (G.M.T.). The two stations operated on about 40 metres, and the power at 1RG was 200 watts.

o o o o

**UNKNOWN STATIONS.**

News of identity is desired regarding BAR, heard on 40-50 metres on May 27th, and A8VA working on the same wavelength on May 30th. The identity of 7M is also sought.

o o o o

**SCHOOL WIRELESS PRIZE.**

Two schools share the honour of carrying off the prize of five guineas, offered by the British Broadcasting Company for the best scheme of school wireless work. Many schools competed, and the task of judging the entries was no easy one. The winners are: St. Paul's School, Dorking (headmaster, Mr. R. J. Hibberd) and Acland Central School, London (headmaster, Mr. F. Lineker).



**WIRELESS IN MOTOR TRIAL.** Captain Richard Twelvetrees, giving a demonstration with the portable "Radiola," prior to his start on the London-Edinburgh trial. Excellent reception of the London station was obtained at Windermere.

**WIRELESS DISPLAY AT STOCKHOLM.**

During the present week, Stockholm is holding a wireless exhibition. In view of the fact that Russia, among other countries, is exhibiting, it is expected that many novelties are on view, and reports are awaited with interest. Among the Russian exhibitors is the Radio Institute of Nijni-Novgorod, at which research work is carried on by the celebrated

**YOUR CALL SIGN ?**

*For the benefit of others as well as themselves, amateur transmitters are earnestly requested to co-operate in the preparation of reliable information regarding call signs, etc., by forwarding full particulars of their stations to the Editor of "The Wireless World," 139-140, Fleet Street, London, E.C.4.*

Russian professors Lossev and Bont-Brujewitz.

An attractive item among the exhibits is the display of amateur transmitters under the auspices of the Scandinavian Radio Relay League.

o o o o

**WIRELESS ON THE "LONDON TO EDINBURGH."**

The experiences of a competitor with a portable wireless set in the famous "London to Edinburgh" motor run have been interestingly described by Captain Richard Twelvetrees, who left London on May 29th by car, bound for Edinburgh, carrying with him a "Radiola" portable set.

After many attempts to incorporate wireless apparatus as a permanent fixture in the car, Capt. Twelvetrees came to the conclusion that the best solution is a really efficient and compact portable set. The "Radiola," together with a frame aerial, was therefore taken, and as a result Capt. Twelvetrees, his fellow-passengers, and many other competitors were able to enjoy an impromptu concert from 2LO until Biggleswade was reached.

On the return journey, after the set had been subjected to the severest buffeting owing to the roughness of the roads, it was tuned in on 2LO at Windermere, 260 miles distant, and gave perfect results. The stability of the set was remarkable, and fading was only occasional.

o o o o

**HOPE IN IRISH FREE STATE.**

The native optimism of the country is expressed by the *Irish Times*, which says: "If everything goes well, broadcasting in the

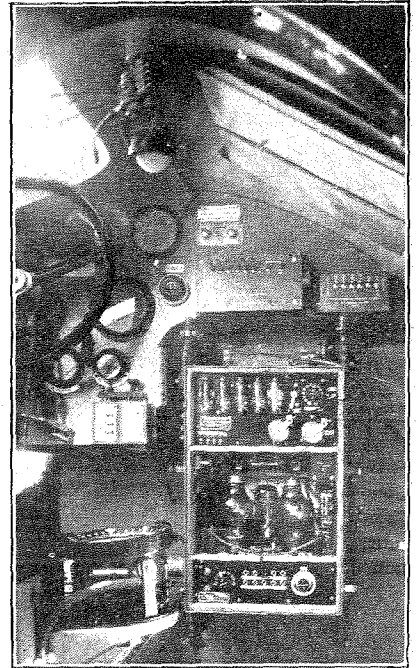

**COMPRESSED EFFICIENCY.** The problem of space has been dealt with very effectively in designing the Marconi A.D.6 aircraft apparatus, seen in this photograph.

Free State will begin this side of Christmas."

As a site for the Dublin broadcasting station, a military barracks on the northern outskirts of the city has been selected. According to the Secretary of the Irish Post Office, it is hoped to broadcast the very best of English and other programmes. It remains to be seen, however, whether the existing cable from England to the Irish Free State is suitable for musical reproduction.

o o o o

**THE MARCONI-SYKES MICROPHONE.**

In the *Wireless World* of May 6th and 13th reference was made to the above instrument, which was erroneously described as the "Round-Sykes" microphone. It is, of course, correctly known as the "Marconi-Sykes" microphone, and we regret the mistake.

In the last paragraph on page 46 of our issue of May 6th it was stated that the microphone in question was evolved from that in use by the B.B.C. in 1923. This is an error, as the Marconi-Sykes microphone was developed before that date.

o o o o

**DO YOU WANT A WIRELESS STATION ?**

The British Admiralty wireless station near St. John's, Newfoundland, is for sale. Built during the war at a cost of £50,000, this station is now more or less obsolete, and will be sold either whole or in parts.

o o o o

**THE THERLA CONDENSER.**

The sole agents of the Therla condensers, referred to, on page 559 of our issue of June 3rd, are Messrs. Sel-ezi Wireless Supplies Co., Ltd., 6, Greek Street, W.1.

# FIELD DAY

## with a Portable Transmitter.

Enterprise of London Radio  
Societies.

**T**HE long range experiments of Saturday-Sunday, 6-7th instant, with portable field apparatus, conducted by the Golders Green and Hendon Radio Society, assisted by the Hounslow and District and the Inland Revenue Radio Societies, have attracted considerable interest.

Owing to the magnitude of the undertaking—the biggest organised outdoor test ever yet conducted by amateurs—details of results achieved will not be available for some weeks to come, since New Zealand, Australia, South Africa, U.S.A., Italy, France, and other countries participated.

The call sign G5CT belonging to Mr. W. J. Turberville-Crewe, the hon secretary, of the Golders Green Society, was used by a portable station at Mill Hill, and, despite an electrical storm, which lasted from midnight until the small hours of the Sunday morning, rendering reception difficult, attempts were made to raise an American first district amateur, who was reported replying.

The equipment consisted of two Hartley coupled transmitters, working on 45 and 175 metres respectively, the apparatus being completely self-contained, even to the detail of accumulator charging plant.

Mr. Woodhams, of the Park Motor Co., London, placed a luxurious caravan, lorry, and car at the disposal of the Society, and this was used for the 45-metre station. The power valve was a T250, and this, together with a battery of U1 and U3 rectifying valves, were provided by the Marconi-Osram Valve Co.; in fact,



The transmitting and receiving equipment at Mill Hill.

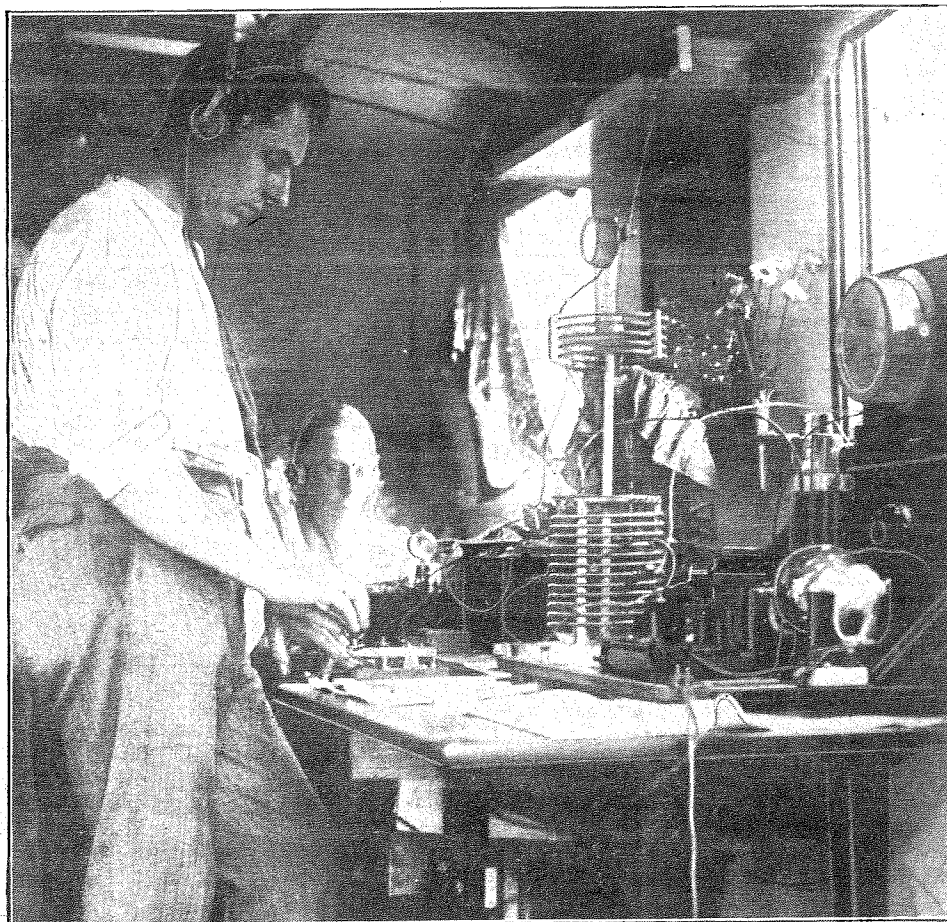

The transmitting set in Mr. Woodhams' caravan, which was loaned for the occasion. Mr. Maurice Child is at the key and Mr. Woodhams behind.

**Field Day with a Portable Transmitter.—**

the whole of the valve equipment for transmitters and receivers was of that make.

An ingenious device provided H.T. supply and proved completely satisfactory. The near-side back tyre was removed from the Sunbeam car, and a belt drive taken to a Telefunken alternator delivering 250 watts at 100 volts. This feed was stepped up to 3,000 volts through a Dubilier oil transformer, and led to the rectifying unit. By an overhead cable this rectified H.T. was also available at the 175-metre station, situated some 150 yards away; but, during the night, this power cable was disconnected and utilised to feed current from the caravan for the lighting of the tent which housed the long-wave gear. This latter transmitter, which was used primarily for intercommunication with European amateur stations, whilst the 45-metre set carried on with the serious work, operated meanwhile with an Evershed and Vignoles hand generator which gave yeoman service.

By means of a relay key—the one used last year in the train experiments of the Radio Society of Great Britain, both stations could be linked up and c.w. transmissions sent out on the two wavelengths simultaneously.

The experiments were made possible through the kindness of the G.E.C., Zeniths, Dubilier, Evershed, Peranne, McMichael, Portable Utilities, Ltd., and

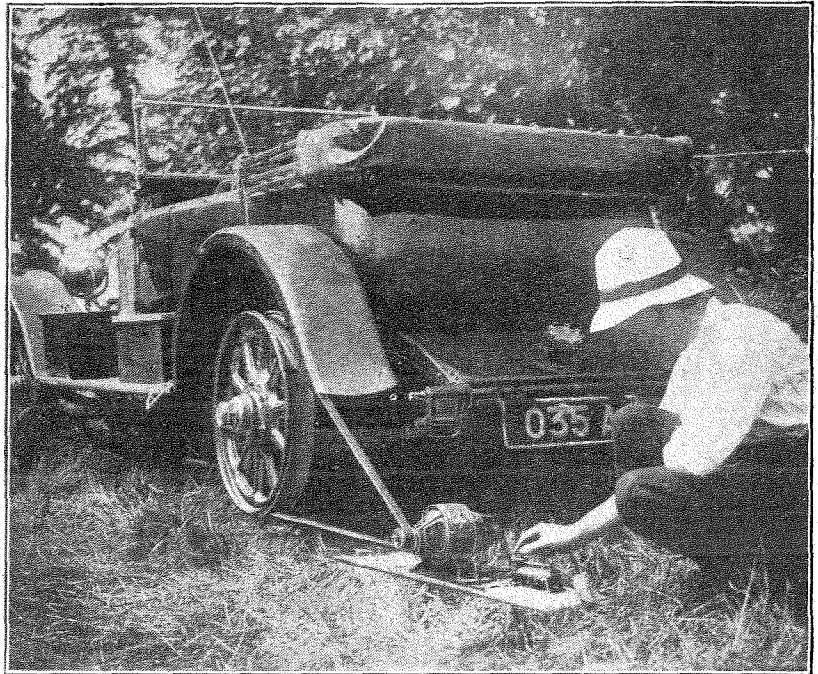

The method adopted for running the Telefunken H.T. generator.

several other manufacturers, who loaned valuable apparatus.

The enterprise shown by these societies sets an example which other societies would do well to follow during the summer months. When a number of societies combine forces there is every opportunity for organising a most successful field day. It is always essential that such an event should be well organised, especially where intercommunication between two or more points is the aim. A little more attention to this point will often prevent failure. The interest of the event to some members can always be enhanced by paying attention also to the social possibilities which an outdoor event provides.

It is interesting to note that one of the results of these tests will constitute a record of historical interest, if confirmation is received, as for the first time America has been raised by means of portable field apparatus operating on short wave and with a power of only 150 watts.

Further tests are, we understand, to be carried out in the course of a few weeks.

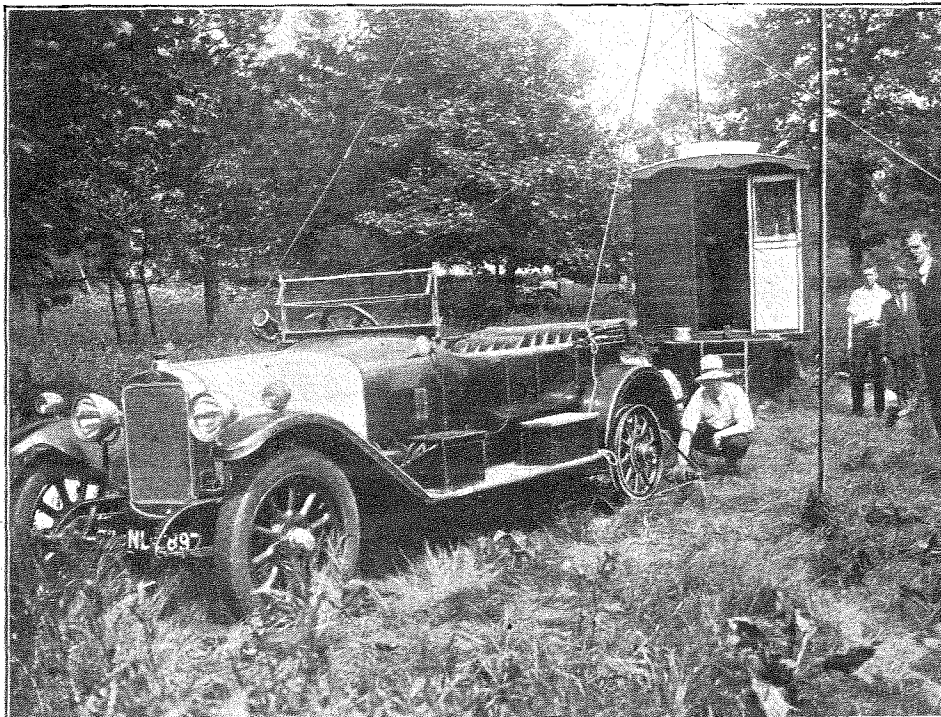

The complete equipment of the portable station, showing the caravan which housed the transmitter and the generating set.

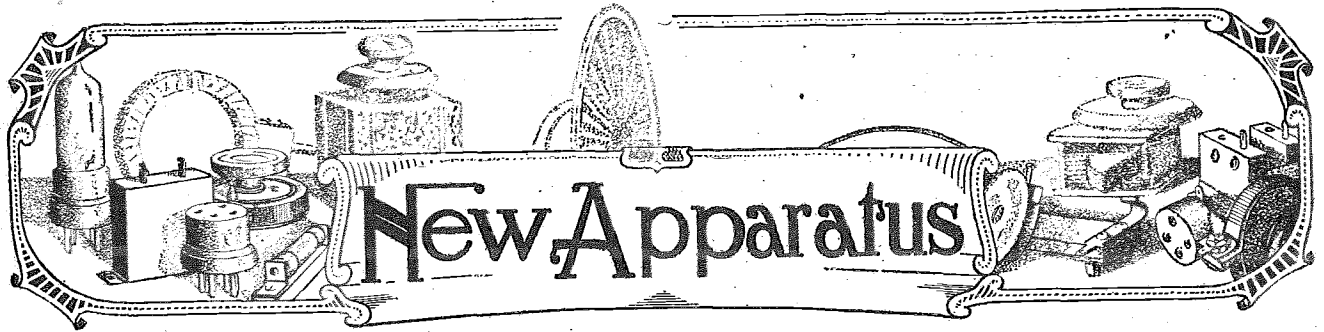

## A Review of the Latest Products of the Manufacturers.

### A SUPPLE-BLADED VARIABLE CONDENSER.

An unusual departure in variable condenser design has recently appeared on the French market. It consists of a semi-cylindrical fixed plate, faced with mica,

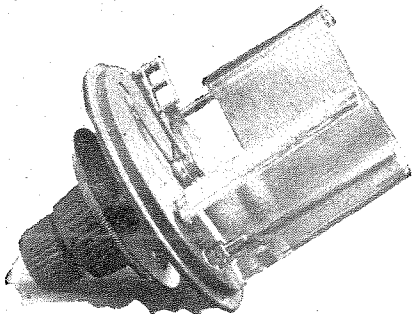

A French variable condenser of unusual design.

while the spindle, which is rotated by the dial, actuates an arm to which is attached a piece of fine bronze gauze. As the spindle revolves the gauze is caused to wind upon the surface of the mica, thus producing a capacity change. A vernier control is arranged for by a concentric knob operating a second arm, and to which is attached only a thin strip of gauze, so that when brought into contact with the face of the fixed plate only a small change in the total capacity results. This condenser is manufactured by J. Lagarrigue, 50, Avenue Gallieni, Bagnolet, Seine.

### A USEFUL VALVE HOLDER.

It is no longer the adopted practice when fixing valve holders to an instrument panel to employ a type which projects, for in so doing the height of the valves is increased, thereby adding nearly an inch to the total height of the receiving set. Where space is limited, short stems are inserted directly

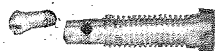
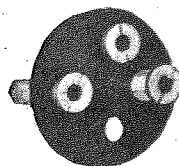

A flush type valve holder which does not need tapped holes for securing to the instrument panel.

into the panel, and to avoid the necessity for making tapped holes Messrs. J. N. Hewett and Co., 315-317, High Road, Chiswick, have introduced a pattern which makes use of an ebonite plate which is attached beneath the panel. This plate has four tapped holes, and the valve stems, in passing through clearance holes in the panel, engage on the plate, and are thus held securely in position.

o o o o

### A NEW ORMOND CONDENSER.

The Ormond Engineering Co. has always shown considerable enterprise in the marketing of reliable variable condensers at moderate prices.

Certain developments have recently taken place in receiver condenser design, and these have at once been incorporated in

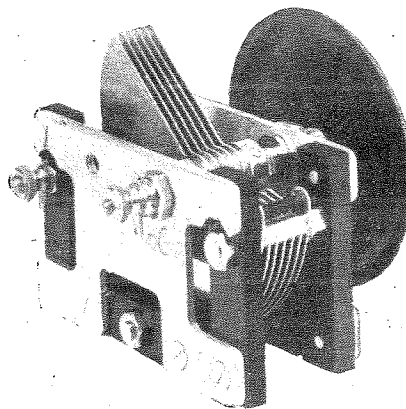

A new pattern Ormond condenser.

the new type condenser which is now offered. The principal aim in this new instrument has been to limit losses by suitably distributing the electrostatic strain through the insulating materials used to support the fixed plates. The moving plates moreover, are no longer insulated from the end mounting pieces, and thus the spindle and end plates can be arranged to be connected on the earth side of the circuit.

A good feature of the new condenser is that a plain spindle is fitted through the main bearing, whilst the dial which is of a new and attractive design, is held in position by means of a set-screw.

### THE PYE CHOKE AND THE PYE TRANSFORMER.

When a valve of the power type is employed in the final stage of a low-

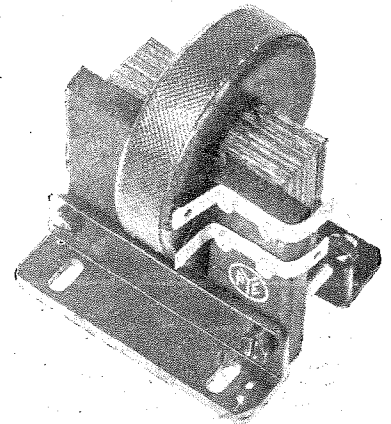

Messrs. Pye's low-frequency choke coil.

frequency amplifier, it is usually not satisfactory to connect a loud-speaker directly in the plate circuit, for the plate current may at times be quite considerable. It is advisable to employ an arrangement which prevents the steady plate current passing through the instrument. There

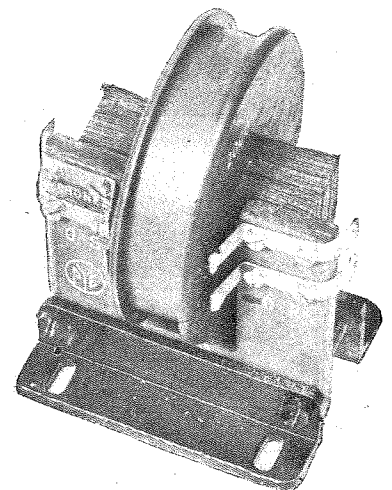

The "Pye" transformer.

are two usual methods of doing this: in one a transformer is used, and in the second method a choke and condenser may be employed to form a filter. An excellent transformer is illustrated here, and is suitable for 2,000 ohms loud-speakers. The choke is quite suitable for use in a filter circuit and for a choke-coupled amplifier.

These components are made by Messrs. G. W. Pye, of Cambridge.

o o o o

**THE GENERAL ELECTRIC CO.'S  
LOUD-SPEAKER.**

The Gecophone loud-speaker has one or two unusual features which indicate that a good deal of care was taken in its design. In the first place, the reproducer itself is housed in a case of massive construction, and the position of the diaphragm with respect to the poles of the permanent magnet may be critically adjusted by moving the lever which projects through the side of the case. The second point of interest is the provision of four terminals, by means of

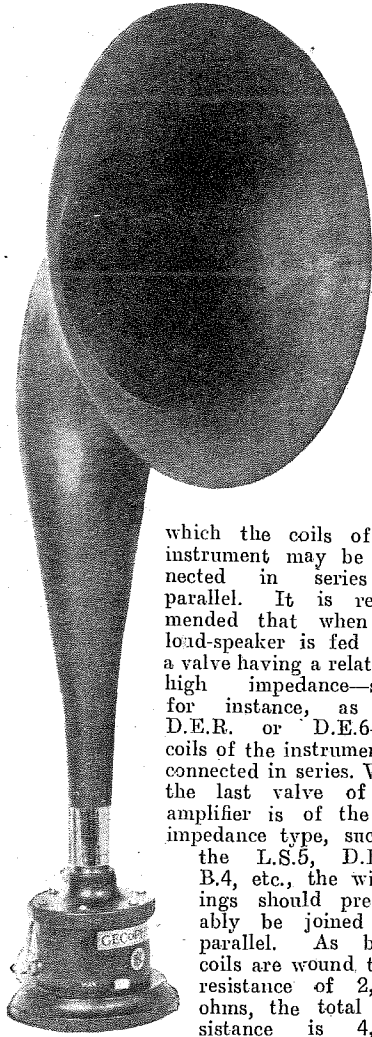

The Gecophone loud speaker.

which the coils of the instrument may be connected in series or parallel. It is recommended that when the loud-speaker is fed from a valve having a relatively high impedance—such, for instance, as the D.E.R. or D.E.6—the coils of the instrument be connected in series. When the last valve of the amplifier is of the low impedance type, such as the L.S.5, D.E.5, B.4, etc., the windings should preferably be joined in parallel. As both coils are wound to a resistance of 2,000 ohms, the total resistance is 4,000 ohms when they are connected in series,

and 1,000 ohms when they are in parallel. With the latter connection the current passing through the individual windings is approximately half that when they are joined in series.

The horn is of ebonite, with a metal cap fitted to the end which fits the opening of the housing of the mechanism. It is of large size, and of rather peculiar shape, as is shown by the illustration. When tested the instrument was found to give good reproduction, to be sensitive to weak signals, and not easily overloaded.

o o o o

**SOLDERING FLUX.**

A specimen of liquid soldering fluid has been received from the Zenith Super-Flux Co., 78, Commercial Road, Southampton.

It is quite satisfactory for causing solder to readily take upon metal surfaces, and can be recommended for instrument work where there is no objection to the use of soldering fluxes other than resin.

o o o o

**THE "ONDIA" WAVEMETER.**

Only a limited number of reasonably priced wavemeters are available on the amateur market, and the new "Ondia" wavemeter marketed by Messrs. Goodchild and Partners, Ltd., 58, Eagle Street, W.C.1, is an instrument which is particularly suited for elementary home experimental work and can be used for the purpose of tuning a receiver by means of its buzzer, or for determining the wavelength of a transmitter with the aid of the small glow-lamp with which it is fitted. It is of simple construction, and is tuned by means of a variable condenser, and the wavelength range is covered by seven plug-in inductances.

Five tuning charts are supplied with the instrument, covering a wavelength range from 25 to 4,900 metres. An unusual feature of the instrument is the provision of additional terminals, so that inductance and capacity measurements can be made by the substitution process.

The "Ondia" wavemeter, suitable for inductance and capacity determinations as well as tuning receiving and transmitting apparatus.

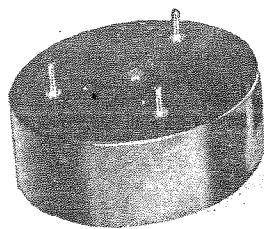

**THE "ACME" FILAMENT RHEOSTAT.**

The Acme Production Co., Ltd., Smethwick, Birmingham, have recently added a filament rheostat of neat design to their series of components.

A feature of particular interest in the design is the method which has been adopted for making contact with the resistance wire. The contact arm, which is

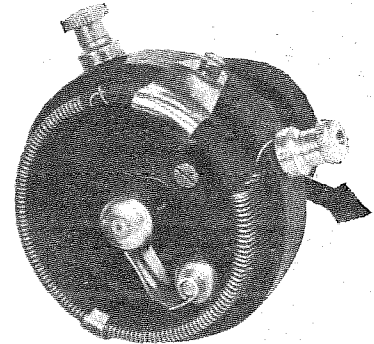

The "Acme" filament resistance with wheel contact.

especially shaped, is cut from spring material, and carries at its extremity a small wheel pressing against the inside of the resistance coil. The result is a positive contact which is perfectly smooth in action and which does not tend to displace the turns in the resistance coil.

The resistance element is wound on a flat strip of bent resisting material fitting in an annular groove in the moulded body of the rheostat. A long bearing is provided for the spindle, and the bearing bush, with one of the terminals already screwed into the side, is embedded as an "insert" during the process of moulding. An extremely fine thread is cut on the bearing, and a suitable nut provided for "one-hole" fixing.

The rheostat is well finished and is neat in appearance, the moulding being approximately 2in. in diameter. Two resistance values are available—15 ohms and 20 ohms, the retail prices being 3s. 9d. and 4s. respectively.

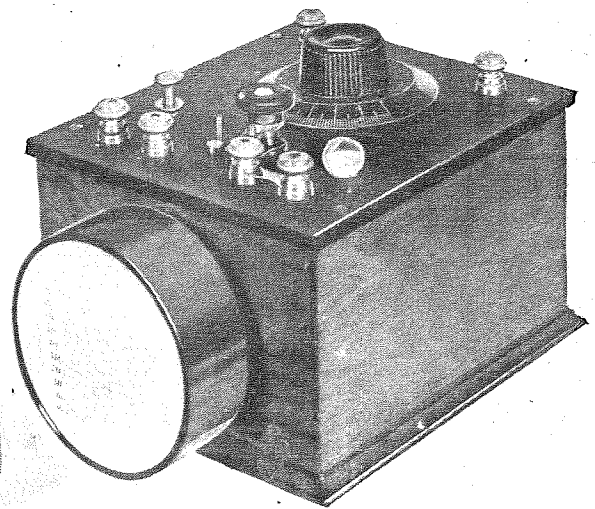

## NEWS FROM THE CLUBS.

Secretaries of Local Clubs are invited to send in for publication club news of general interest. All photographs published will be paid for.

### Croydon Wireless and Physical Society.

An outstanding feature of the Society's Summer Programme is the number of visits to places of interest which have been arranged. By kind permission of Mr. E. H. Shaughnessy, O.B.E., M.I.E.E., members of the Society will visit the Northolt Radio Station on Wednesday, July 15th. Another interesting fixture is that arranged for August 15th, when, by courtesy of the Chief Engineer of the Metropolitan District Railway Co., a visit will be made to the Lots Road Power Station.

It is also proposed to visit the M.O. Valve Company's works, Brook Green, Hammersmith, on September 17th, and further particulars will be announced in due course.

Hon. Secretary: Mr. H. T. P. Gee, 51 and 52, Chancery Lane, W.C.2.

o o o o

### Worthing Wireless Society.

As many as 250 people were present at the inaugural meeting of the Worthing Wireless Society on Tuesday, May 26th,



Demonstrating a five-valve receiver and portable transmitter. The North Middlesex is one of the oldest clubs, having been formed in 1914. Mr. H. A. Green, Hon. Secretary of the Club, is seen on the extreme right.

### FORTHCOMING EVENTS.

WEDNESDAY, JUNE 17th.

Golders Green and Hendon Radio Society.—  
At 8 p.m. At the Club House, Willifield Way, N.W.11. Demonstration with the Society's apparatus.

SATURDAY, JUNE 20th.

Eastern Metropolitan Group of Affiliated Societies.—Field Day.

when Captain P. P. Eckersley, Chief Engineer of the B.B.C., delivered a lecture on "The History of Broadcasting in Britain."

In opening his remarks, Captain Eckersley stated emphatically that broadcasting did not start in America, and he proceeded to describe the earliest broadcasting experiments, which were carried out at Chelmsford in 1919, when Dame Nellie Melba contributed to the "programme." Although after that time broadcasting was temporarily dropped, British amateurs kept the flag flying until, after urgent entreaties, the Postmaster-General gave permission for the erection of a 250-watt experimental broadcasting station at Writtle, Essex. After countless difficulties and disagreements, the idea of a British Broadcasting Company was conceived, embodying the many firms who simultaneously sought to obtain broadcasting rights. The result was the present system of unified broadcasting control in this country, differing so greatly from the confused state of affairs in America.

The lecturer concluded with remarks on the upkeep of broadcasting stations, and in referring to the new high power station at Daventry, regretted that the abandonment of Chelmsford might mean poorer crystal reception on the south coast. He assured his hearers, however, that plans were in hand for improving reception in the district.

In the course of a short speech on behalf of the Radio Society of Great Britain, Mr. H. A. Rock urged all present to join the Worthing Society, and so serve the best interests of all members of the community.

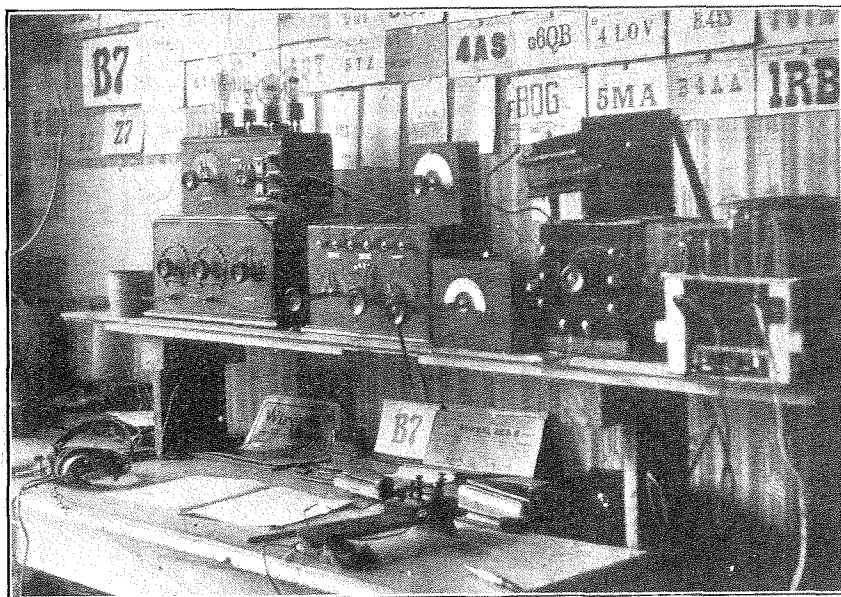

The transmitting room of B7, one of the most active of Belgian amateur transmitters. The owner is M. Constantin Haumont, Traffic Manager of Réseau Belge, 11, Rue du Congrès, Brussels. The transmitting apparatus, which is home-made, employs a power of 60 watts.

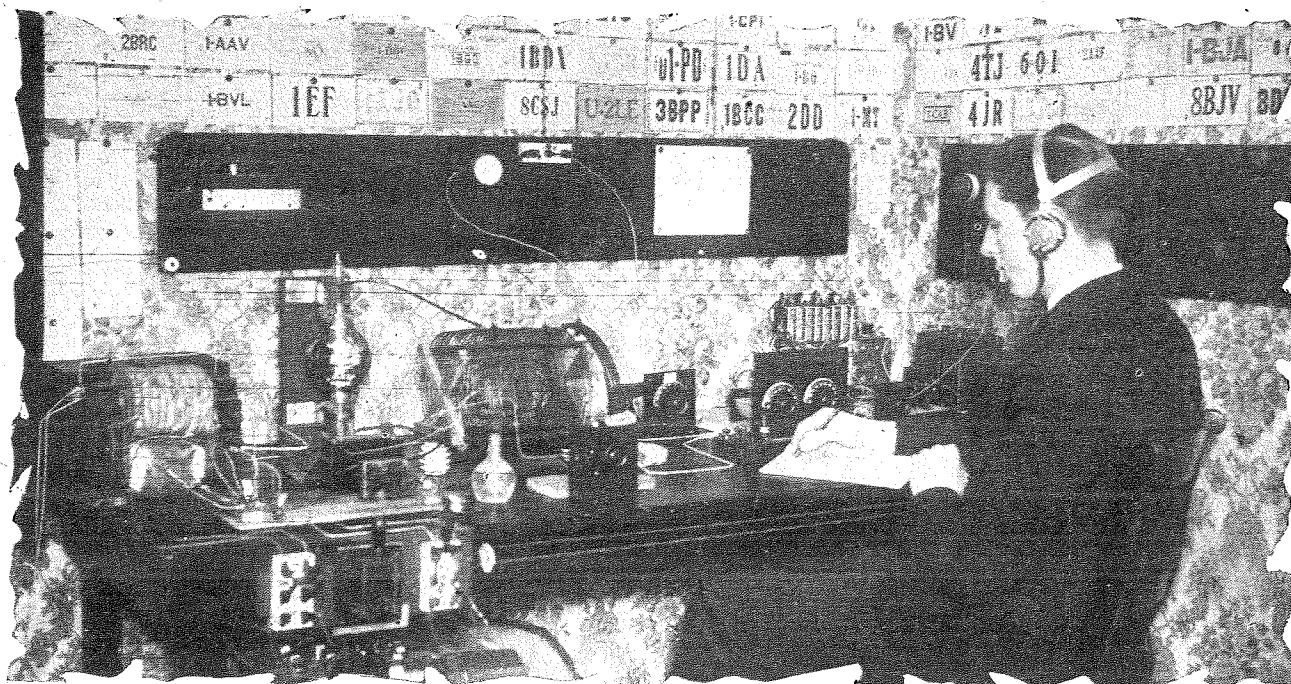

# NOTES ON SHORT WAVE RECEPTION.

Description of an Effective Receiver for Short Wave Work.

By S. K. LEWER, 6LJ.

NOW that the shorter waves are being used by amateur, broadcast, and commercial stations in all parts of the world there is a demand for short-wave receivers. Such astounding results have been obtained that it is obvious that the short waves have come to stay.

The receiver here described represents eighteen months' work on short-wave reception. No claim is made to novelties, but there are a few points included which are too often neglected. These, together with the design and adjustment of the receiver, form the major part of this article. At first sight they may appear unnecessary, but the writer attributes his good reception only to the small details and not to an exceptionally high aerial nor to an exceptionally good pair of ears. Much of the long-distance work has been done while using a single earpiece which was truly on its last legs. It was a Brown's "A" type earpiece, almost totally demagnetised, and its diaphragm had been repaired with a piece of tissue paper. Moreover, only one winding was used, the other having burned out. The aerial was at first a single wire 70ft. long and 30 ft. high, but was changed to a 4-wire cage 30ft. long and 30ft. high. Both were very badly screened, being well below the tops of the neighbouring houses and trees. The receiver itself, therefore, was unusually efficient. Being now somewhat more interested, we will consider Fig. 1. This is an ordinary single-valve reacting receiver, which no doubt will be regarded as being unsuitable for very short

wave work. We will, however, consider each point in detail. The most vital point is the tuner. The more simple it is the better. Let us investigate the tuner step by step.

In the days before broadcasting the single-circuit tuner shown in Fig. 2 was in common use, and worked fairly well. When the lower waves were being tuned the coil became so small that oscillation could be maintained only with difficulty. Then a modification was introduced, Fig. 3. The inductance in the grid circuit was kept large, but the aerial was tapped on a lower point on the coil. The circuit works remarkably well down to very short waves. This is closely connected with the Reinartz tuner. In order to make the tuner more selective the aerial section of the coil was separated. This brings us to the familiar loose-coupled tuner shown in

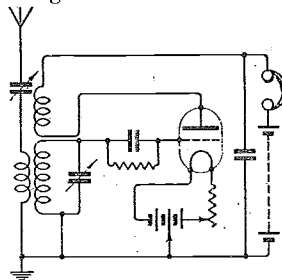

Fig. 1.—A single valve receiver having tuned aerial and secondary circuits with magnetic reaction.

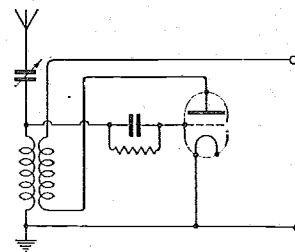

Fig. 2.—A single circuit receiver with reaction.

**Notes on Short Wave Reception.—**

Fig. 1, which works very effectively down to about 10 metres. Of course, on waves below, say, 50 metres sufficient aerial coupling may be obtained by running the aerial within a few inches of the secondary coil. The coupling effects on the very low waves are somewhat remarkable. We often hear of the reception of a

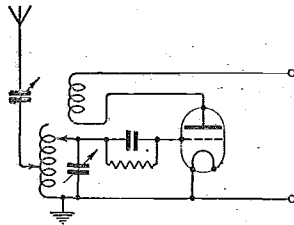

Fig. 3.—A modification of fig. 2: the aerial is connected through a condenser to a tap on the tuning coil.

station a thousand or so miles away without aerial or earth.

In many cases a large amount of energy is passed to the set by the aerial switch. Even when the aerial and earth leads are disconnected and allowed to swing clear of the set the signals may still be audible, since the aerial re-radiates all waves that are near its

fundamental. To return to the tuner: we have decided that the best form of tuner is the loose-coupled type, the secondary of which must be tuned, but the primary may be untuned.

**Adjustable Reaction.**

Reaction is always a desirable feature on short waves. Capacitative reaction has apparently been generally discarded. Inductive reaction is very effective and has been made to operate on waves of 1 or 2 metres. In most cases the straightforward form, as in Fig. 1, is used. In this system there is one troublesome disadvantage. Every time the reaction coil is moved the wavelength of the secondary circuit shifts about, and searching for weak stations is made very difficult. For the successful operation of a tuner it is necessary that the operator should "know where he is" or get the "knack" of the thing. It is well nigh impossible to do this if the wavelength cannot be easily controlled at all times.

Some amateurs seek other methods of controlling the oscillation. There are three methods. The first is very well known: it is the tuning of the reaction coil with a small variable condenser. It is efficient and has very few faults. Another way is to tune the aerial circuit in conjunction with the secondary circuit. In order to stop oscillation the series

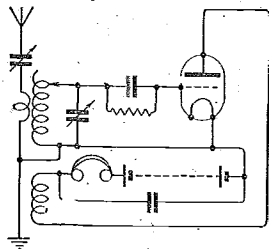

Fig. 4.—When magnetic reaction is employed it is better to couple the reaction coil to the filament end of secondary coil as indicated here.

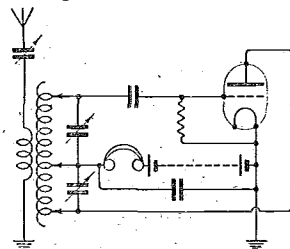

Fig. 5.—A circuit of the Hartley type.

condenser in the aerial circuit is varied until that circuit is nearly in resonance with the secondary circuit. In this way energy is absorbed and oscillation ceases. The control is smooth, and the method has an advantage in that the aerial circuit is tuned as closely as possible under

the circumstances to the received wave. If the reaction coil is coupled closer, then the aerial circuit may be tuned exactly to the received wave. The increase in signal strength on short waves, however, is very slight. The coupling of the aerial coil could, of course, be varied, but this varies the wavelength of the secondary circuit because one end of the secondary coil is connected to the aerial coil. The aerial coil, therefore, acts as part of a variable condenser. The lead from the secondary coil to earth stabilises the tuner in some manner, and it is better not to dispense with it. Another method of controlling oscillation is to vary the shunting capacity across the phones or the primary of the intervalve transformer in the detector anode circuit. A condenser of about 0.001 mfd. maximum capacity will be required. It has the enormous advantage of having very little effect upon the wavelength.

**A Good Tuner.**

Now consider Fig. 4, which is the same as Fig. 1, except for a change in the position of the anode circuit. Incidentally, the circuit might always be drawn in this form, since it reminds one of the fact that the reaction coil should be placed at the filament end of the

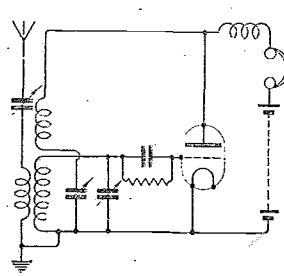

Fig. 6.—Shunt reaction connected to a single valve reacting receiver.

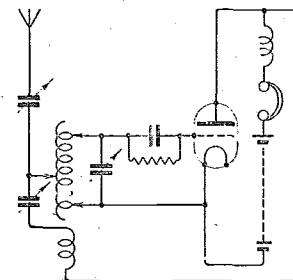

Fig. 7.—The Reinartz receiver.

secondary. By taking the lead from the bottom of the secondary coil to the junction of the phones and the reaction coil, instead of to the filament, we get a Hartley circuit, Fig. 5. This is the circuit that results when the filament of the H.F. valve in a tuned-anode circuit is not heated. One coil with taps may be used. The circuit is very efficient and works well on extremely low waves.

In these methods of obtaining oscillation "series reaction" has been used. "Parallel" or "shunt" reaction is equally effective and perhaps a little more easily controlled. Fig. 6 shows the usual circuit fitted with shunt reaction. The circuit is exactly the same as the Reinartz circuit, which is usually drawn in the form shown in Fig. 7. This has been so often described that only its relation to the usual circuit will be mentioned here. The Hartley, fitted with shunt reaction, as in Fig. 8, is a very efficient all-round short wave tuner. Tuners with switching arrangements should be avoided.

If you wish to test a new tuner, stick to it and get the "knack" of it before losing hope. On the other hand, if you want a circuit which you know will give results, try the one shown in Figs. 1 or 8. They are equally effective, and the question will be decided by the type of coils to be used, since the Hartley secondary coil (Fig. 8) must be tapped.



Notes on Short Wave Reception.—

Being provided with a reliable and efficient tuner, we may reasonably hope to be able to tune in all manner of good things if we have a detector. But the detector must also be efficient. If the detector is to be efficient, it must be treated carefully. By this is meant that it must have

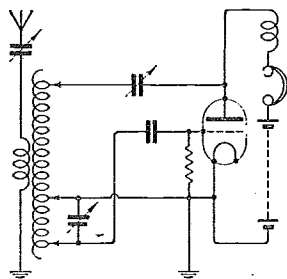

Fig. 8.—Another effective circuit.

the correct normal grid potential, correct anode voltage, and correct filament temperature. These can only be found by experiment. The points to be remembered when testing valves are that no two valves require exactly the same potentials, and that it is utterly impossible for the human ear to detect slight changes in the intensity of loud sounds. When testing, always listen to very weak stations—after having made certain that no fading occurs. Speaking generally of valves of the usual makes, any valve may be made to operate with reasonable effectiveness as a detector. Cheap foreign valves are often exceptionally good. The grid condenser is not very important. One of 0.0002 mfd capacity is suitable, providing it has a good dielectric. The grid leak is often a source of trouble, and is generally the cause of many disturbing noises in the phones. Most of the variable type are not satisfactory—they are too variable. Fixed leaks are more satisfactory.

A single-valve receiver never produces really strong signals, although its range may be extraordinary. A low-frequency amplifier will increase the audibility of all stations and will increase the range. Until recently there was a general idea that if a station could not be heard on one valve, then it could not be heard with any number of L.F. amplifiers added. That was partly true, however, because the station may be inaudible on one valve, just audible with one L.F. amplifier, and yet may be lost in the mush with a second amplifier. It seems absurd to limit the capabilities of the detector to the

sensitivity of the operator's ear or to that of his phones. One L.F. amplifier is apparently the limit for good DX reception. With two, very strong signals may be obtained, but the weak ones are lost. The less said about H.F. amplification on short waves the better. For the L.F. valve, any hard one seems to work well, but great care must be taken of its operating conditions, as in the case of the detector. If only code work is to be done a transformer with a high ratio, say 1:10, should be used if possible. The writer once tried a one-inch spark coil and found that it amplified remarkably well, considering the extremely low impedance primary. Results should be very good if a new primary of three or four thousand turns of No. 40 D.S.C. is put on. A little capacity across the primary would probably be helpful. The point is to amplify the signals at one frequency; which is really much easier to do than to amplify all frequencies equally at once. The circuit used at present at the writer's station is shown in Fig. 9, and the tuner is the same as that shown in Fig. 1. The reader will see that separate H.T. tapings are used. These are absolutely necessary. The filament circuit is represented as it is arranged in the receiver, which is illustrated in Figs. 10 and

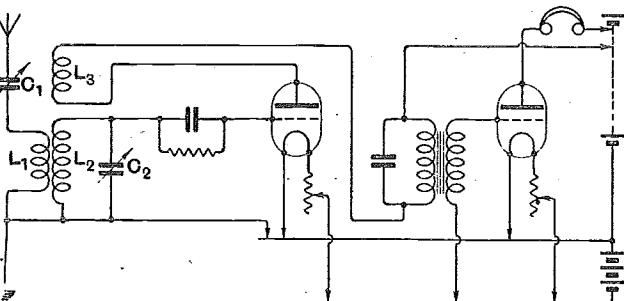

Fig. 9.—Connections of the writer's receiver.

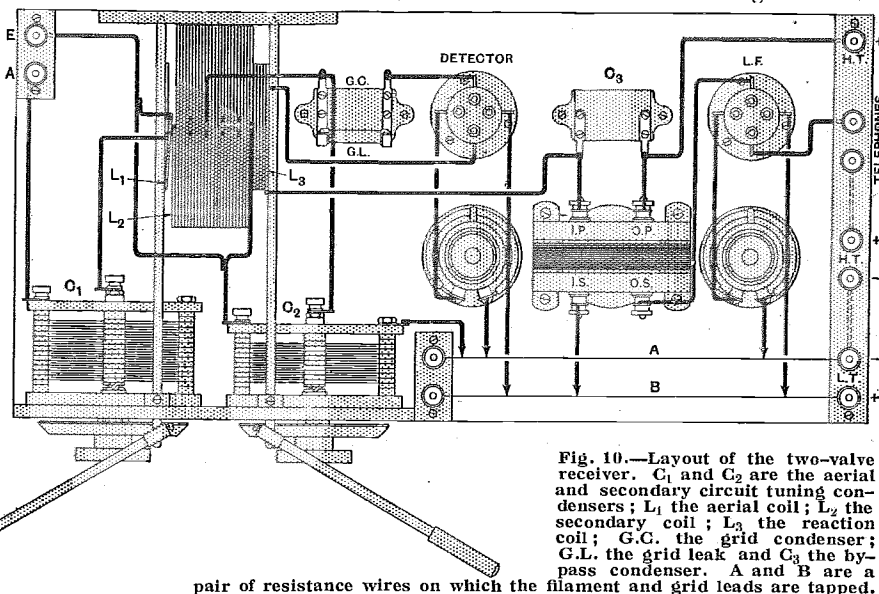

Fig. 10.—Layout of the two-valve receiver. C<sub>1</sub> and C<sub>2</sub> are the aerial and secondary circuit tuning condensers; L<sub>1</sub> the aerial coil; L<sub>2</sub> the secondary coil; L<sub>3</sub> the reaction coil; G.C. the grid condenser; G.L. the grid leak and C<sub>3</sub> the bypass condenser. A and B are a pair of resistance wires on which the filament and grid leads are tapped.

11. By using this system it is a simple matter to try all possible filament and grid connections, and consequently to be certain that each valve is working at its highest efficiency. It is not generally realised that different grid potentials may be obtained by connecting the grid lead to various points on the filament circuit. Fig. 12 illustrates this. Of course, intermediate potentials could be obtained by tapping the junctions of the cells in the accumulator. With the filament circuit so accessible it is a simple matter to adjust the valves, and any jerkiness in the oscillation, known as "overlap," may readily be eliminated. The receiver is most sensitive when it is just oscillating, and if oscillation starts and ceases with a click, it is impossible to adjust the set correctly.

The value of the H.T. will depend to a very great

**Notes on Short Wave Reception.—**

extent upon the particular valve, but, at any rate, voltages above 50 are rather apt to make the set noisy. Attempts should be made to reduce the natural noise as much as possible without reducing the efficiency. In searching for the source of extraneous noise, the possibility of a faulty valve should not be overlooked. It will be found that a slight hiss is present with most valves even when the characteristics are perfectly normal. For special long-distance work, therefore, the valves should be selected for silent operation as well as for exceptional rectifying and amplifying properties. An H.T. battery built up of accumulator cells is to be recommended both

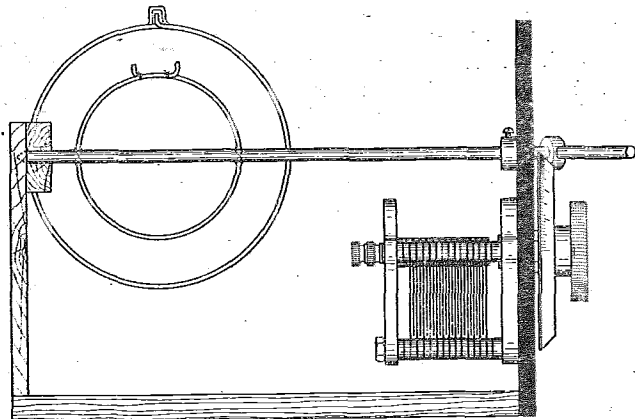

Fig. 11.—End view of the set, showing the closed circuit and aerial coils. The smaller coil is joined in the aerial circuit.

on account of its silent operation and its low internal resistance. When an H.T. battery of the ordinary dry cell type is used, reservoir condensers each of about 1 mfd. capacity connected between each + H.T. tapping and - H.T. are recommended. Noises are often caused by a loose contact in a filament rheostat.

A few details of the coils and condensers may be useful.  $C_1$  in the figures should have a maximum capacity of about 0.0005 mfd.,  $C_2$  0.0001 to 0.0003 mfd.,  $C_3$  0.0003 mfd.  $L_1$  may consist of one turn of any thick wire for waves below 100 m. and three or four turns for waves above 100 m. The secondary coil  $L_2$  must be efficient. The less the solid supporting material the better. The writer uses a basket-weave coil (see *The Wireless World*, page 566, No. 285), consisting of twenty-five turns of No. 16 D.C.C. on a diameter of 4in. A tap is taken at every fifth turn simply by twisting up a short length of the wire and baring it. The reaction coil is one of the basket-weave type of twenty turns of No. 20 D.C.C. tapped every five turns on a diameter of 2½in.

In conclusion, the writer would mention some of his results as a proof of the efficiency of the apparatus. During 1924 alone over 1,000 different American and Canadian amateurs, including thirty on or near the Pacific Coast, were heard. The list includes stations in all the nine American and five Canadian districts. Two Mexican amateurs, BX and 1B, have often been readable from a somewhat inefficient home-made loud-speaker. Signals have also been received from WNP (near North Pole), Mesopotamia, Argentine, Chile, New Zealand and Australia on a single valve. Several of the well-known American stations have been heard as late as mid-day when the entire intervening distance has been in daylight. The Americans are also received at good strength on 40 and 20 metres.

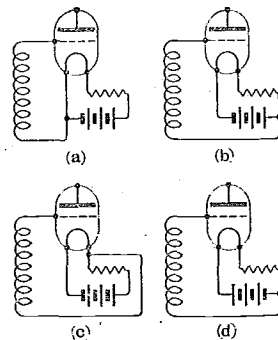

Fig. 12.—Four values of grid bias may be obtained as shown here.

**Lowestoft.**

*British*:—2FU, 2FM, 2GY, 2KU, 2LZ, 2MM, 2OA, 5DA, 5HS, 5LF, 5NN, 5SI, 5SZ, 6GH, 6QB, 6RW, 6XJ. *French*:—8BA, 8BN, 8DKU, 8DKV, 8DU, 8FZ, 8II, 8MU, 8NG, 8OM, 8RG, 8RLH, 8SO, 8VT, 8ZC, 8XAX, 10KZ. *Belgian*:—4JN, 4TU, OCDJ. *Finnish*:—FN, 2CFN, 5NQF. *Spanish*:—EAR2. *Italian*:—1AM, 1FP, 1MT, 1RE, 3RM. *Swiss*:—H9BR. *Mosul*:—GHHL. *Unknown*:—J2 (90 metres, pure C.W.).  
(0-v-1.) P. SAVAGE.

**Sheffield.**

*French*:—8AB, 8AQ, 8BN, 8CK, 8CT, 8DE, 8EM, 8EN, 8ER, 8EV, 8FC, 8FK, 8GG, 8GK, 8GL, 8GN, 8GO, 8GP, 8JB, 8MN, 8MT, 8NK, 8OK, 8PL, 8RF, 8RG, 8RO, 8SG, 8WK, 8WZ, 8XR, 8ZM, 8ALG, 8HSG, 8HSO, 8MJM, 8RLH, 8SQZ, 8SSU, 8SSV. *American*:—1CME, 1CRU, 1GA, 1II, 1YB, 2AFP, 2BY, 2KX, 2RQO, 3AJD, NKF, WGH.  
(0-v-1.) G. ALGER BLYDE.

**Leytonstone, E11.**

*French*:—8AB, 8CO, 8GB, 8G1, 8GN, 8II, 8UD. *Dutch*:—OBA, OGC, OLL, ORE. *American*:—1CRE, 1WB, 4FZ, 9DZ.  
(0-v-0.) H. S. WOODHOUSE (2AHY).

## Calls Heard.

### Extracts from Readers' Logs.

**East Aberthaw, near Cardiff.**

*British*:—2AUC, 2CC, 2DX, 2FM, 2FU, 2JU, 2LZ, 2MM, 2NB, 2TA, 2WJ, 5KO, 5LF, 5MO, 5NN, 5OK, 5TZ, 5JD, 5UQ, 6FG, 6LJ, 6NF, 6RW, 6TD, 6US, 6UV. *Swiss*:—9AD, 9LA. *American*:—U1CX, U1AM, U2XI, U2CZA.  
(0-v-0.) C. PROSSER (2ACK).

**Royal Oak, Michigan, U.S.A.**

*British*:—5NF, 2JF, 6OX, 2SH, 2AWK, 2ZO, 5KO, 5KC, 6RV, 6PL, 2AX. *French*:—8AB, 8AJ, 8BC, 8CO, 8JS, 8BU, 8CK, 8BB. *Dutch*:—0NL, 0LL, 0BQ. *Spanish*:—EAR1.  
ROBT. L. MILLER (U8D00).

**Wimborne, Dorset.**

*British*:—2BE, 2FM, 2NS, 5NM, 5NN, 5PZ.  
W. A. CRIBB.  
(All below 150 metres.)

**Shildon, Co. Durham.**

*British*:—2PP, 2VX, 2FB, 2NJ, 2DR, 5OC, 5MA, 5JK, 5XS, 5RW, 5SI, 6AL, 6MX, 6IG, 6MP, 6TD, 6RM.  
H. VICKERS.

**West Norwood, London, S.E.27.**

*British*:—2CI, 2HD, 2NE, 2OY, 2SW, 2AWP, 2BAX, 5HT, 5HZ, 5UG, 5VL, 5ZR, 6FV, 6JJ, 6JV, 6OK, 6MX, 6UT, 6YD.  
L. F. ALDOUS.

**Lowestoft, Suffolk.**

*British*:—2AG, 2AV, 2GD, 2IH, 2KZ, 2QM, 2RF, 2UU, 5HA, 5WI, 5XY, 6BR, 6CH.  
(0-v-1.) P. L. SAVAGE (2MA).

**Felsted, Essex.**

*Great Britain*:—2AB, 2DR, 2GO, 2JH, 2JN, 2JB, 2JF, 2KG, 2LC, 2LY, 2MC, 2MJ, 2MK, 2MS, 2NB, 2NJ, 2OC, 2PP, 2QD, 2SU, 2SW, 2TO, 2UV, 2XO, 2YZ, 2ZB, 5BH, 5CT, 5DK, 5HA, 5HX, 5JX, 5LP, 5MA, 5OC, 5OK, 5OX, 5PU, 5RB, 5RC, 5SA, 5SI, 5TV, 5TZ, 5ZA, 6AL, 6BO, 6DVS, 6GH, 6GM, 6KJ, 6MP, 6QB, 6RM, 6SV, 6TD, 6US, 6UT, 6UV, 6YG, 6YR.

J. C. EVERETT.

# BROADCASTING IN SPAIN.

EAJ1

## The Barcelona Station.

THE inauguration of the broadcasting station at Barcelona dates back to November of last year. The existence of the station is actually due to the efforts of a group of enthusiasts who, in 1923, founded the magazine "Radiosola," which served to enhance public interest in broadcasting as a powerful instrument of progress. A broadcasting organisation was soon formed, and the president, Senor J. M. de Guillén, was delegated to study broadcasting methods in other countries. The present efficient administration is largely the result of those efforts.

Installed by the S.A. Telephones Bell, concessionaires for the International Western Electric Co., the station occupies a suite of rooms in the Hotel Colon, which is seen in the uppermost photograph. A power of 1 kilowatt is employed, and transmissions are carried out on a

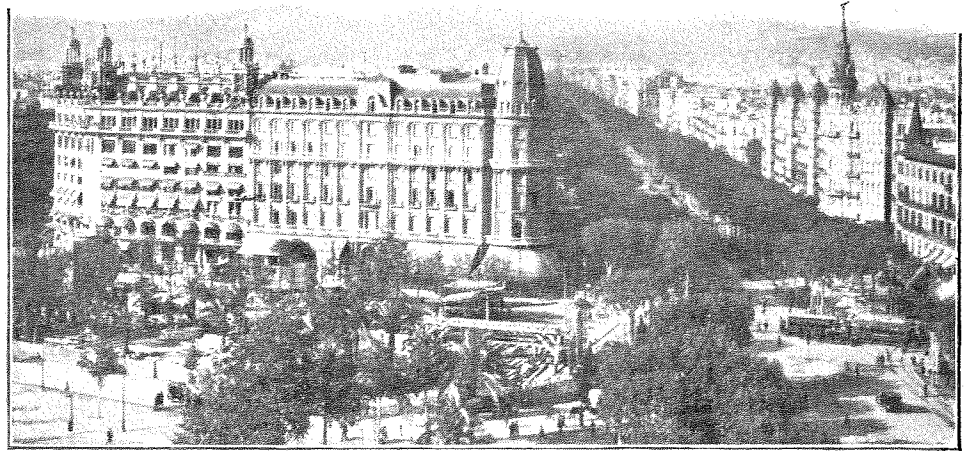

The Barcelona broadcasting station occupies a commanding position in the Hotel Colon, seen in the centre of the photograph. The studio is just under the cupola.

wavelength of 325 metres, the call sign EAJ1 being employed. In the meantime, arrangements are being made for the installation of plant, also of Western Electric origin, of considerably greater power than that at present in use, according to an announcement made by the broadcasting authorities. It is understood that this system makes use of a modified method of modulation differing from the usual choke control arrangement, and listeners will look forward with interest to the performance of the

new transmitter, particularly over long ranges. The station authorities are hopeful that the station will be heard in all parts of Europe and America.

A land line connects the Hotel Colon with the Grand Theatre du Liceu, and during the opera season listeners receive a generous share of the performances.

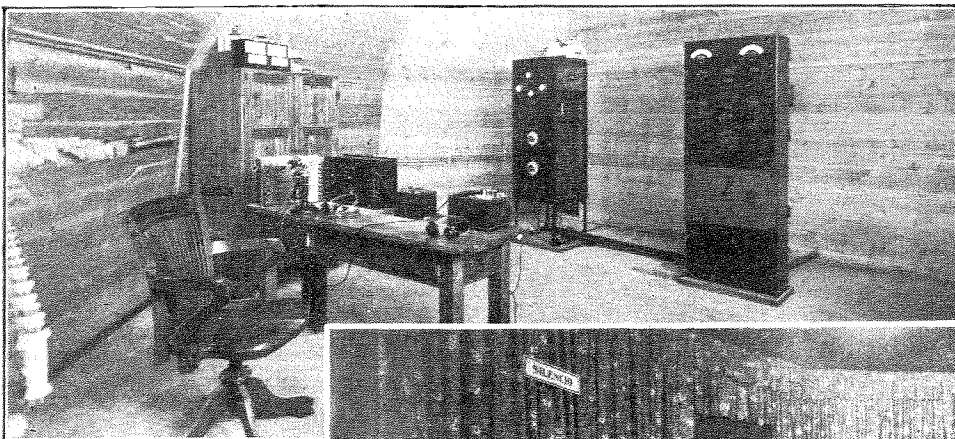

(Above) A view in the control room of the Barcelona broadcasting station. It is understood that the present apparatus, manufactured by the Western Electric Co., Ltd., is to be replaced by the same Company with more powerful plant employing a modified system of modulation, which is expected to yield interesting results.

(Below) The studio at Barcelona. The usual method of draping is used to overcome echo effects.

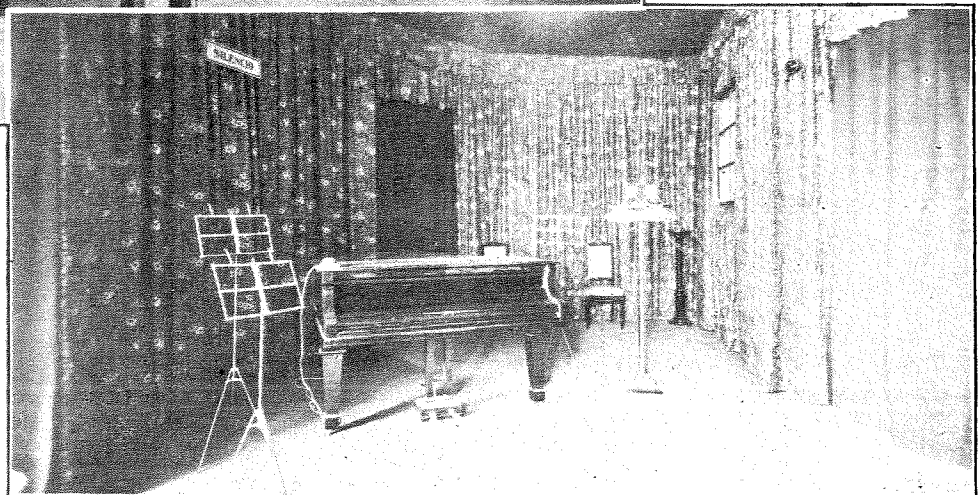

# TESTS ON REFILAMENTED VALVES.

## M.O. Valves Repaired by G.W.I., Ltd.

THE life of a valve, at any rate of the bright emitters, is, in almost every case, determined by the filament. Its decease may have been prematurely caused by, say, accidental overheating, or it may be due to normal old age; but in practically every case filament burn-out is the cause of a valve becoming un-serviceable. Valves are still fairly expensive components, in spite of the recent reductions, and if a satisfactory repair can be effected at a moderate charge, such a service will make an instant appeal, more especially to the man who operates multi-valve sets. It is essential, however, that the repair be satisfactory in all respects, and the valve must be as good as when it left the maker.

One of the pioneer firms to undertake the work of replacing valve filaments was Messrs. G.W.I., Ltd. From small beginnings a large business has been built up, and to-day a modern well-equipped factory is devoted to this class of work.

They have recently supplied us with samples of their work for test purposes, and, judging from the valves submitted, it would seem that this firm is open to repair any type of either dull or bright emitters.

A special process, we are told, is employed, which includes replacing the old interior into a completely new glass bulb, the latter being stamped "G.W.I. repaired valve." Each valve is then submitted to careful tests before being returned to the owner.

### Results of Tests.

The first valve we tried was a repaired M.O. D.E.R. Its filament rating, as given by the makers, is, of course, 1.8-2.0 volts, 0.4 ampere, but the label attached to the repaired specimen gave the following particulars: Filament volts, 1.8-2.0; current, 0.25 ampere average.

The filament current is thus about one-half that of a new valve, which in itself is an advantage, although additional resistance will have to be inserted if other than one 2-volt accumulator is used for filament heating. The table below gives our complete test figures for the valve:—

#### M.O. D.E.R.

(Repaired by G.W.I., Ltd.)

Filament Volts, 1.8. Filament Current, 0.19 amperes.  
Emission (total), Milliamps. 7.2. Filament Efficiency, 21 milliamps. per watt

Plate Volts.	Plate Current. Milliamps.	Grid Bias. Volts.	Plate <sup>1</sup> Current. Milliamps.	Amplification Factor.	Plate Impedance. Ohms.
40	0.7	-1	0.44	9.0	42,500
60	1.20	-2	0.73	9.1	37,000
80	1.9	-3	1.02	9.25	33,300
100	2.7	-4	1.37	9.25	31,000

<sup>1</sup> Plate current when grid is biased to the value of Col. III.

The next valve of the series was an M.O. R.5V., for which the maker's rating is filament volts, 5.0; current,

0.7 ampere. Filament tests on the repaired sample gave the following results:—

Volts	Amps.	Milliamps Emission
4.0	0.45	0.28
5.0	0.505	2.2
5.5	0.53	5.9
6.0	0.555	11.1

from which it will be seen that the minimum working filament voltage for the repaired valve is 5.5, as against the maker's 5.0. Actually, however, this is a matter of small moment, as in either case a 6-volt L.T. battery must be used.

Complete test figures for this valve are given in the table.

#### M.O. R.5V.

(Repaired by G.W.I., Ltd.)

Filament Volts, 5.5. Filament Current, 0.53 amp.  
Emission (total), Milliamps. 5.9. Filament Efficiency, 2 milliamps. per watt

Plate Volts.	Plate Current. Milliamps.	Grid Bias. Volts.	Plate <sup>1</sup> Current. Milliamps.	Amplification Factor.	Plate Impedance. Ohms.
40	0.83	-1	0.58	10.0	42,500
60	1.4	-2	0.855	9.9	36,500
80	2.1	-3	1.13	9.9	35,000
100	2.8	-4	1.45	9.9	33,000
120	3.55	-5	1.76	9.9	30,700

<sup>1</sup> Plate current when grid is biased to the value of Col. III.

The last type submitted to us was an M.O. R., filament tests producing the following results:—

Volts	Amps.	Milliamps Emission
3.0	0.4	1.4
3.6	0.445	6.0
4.0	0.467	11.0

For this sample, then, the filament voltage should not exceed 3.6. Ample emission is obtained at this figure, which, if exceeded, will considerably shorten the life.

Complete test figures are appended.

#### M.O. R.

(Repaired by G.W.I., Ltd.)

Filament Volts, 3.6. Filament Current, 0.445 amp.  
Emission (total), Milliamps. 6. Filament Efficiency, 3.75 milliamps. per watt

Plate Volts.	Plate Current. Milliamps.	Grid Bias. Volts.	Plate <sup>1</sup> Current. Milliamps.	Amplification Factor.	Plate Impedance. Ohms.
40	0.66	-1	0.48	7.75	48,400
60	1.14	-2	0.75	8.0	43,500
80	1.68	-3	1.06	7.7	37,000
100	2.24	-4	1.4	7.7	37,000
120	2.78	-5	1.75	7.7	36,500

<sup>1</sup> Plate Current when grid is biased to value of Col. III.

The appearance and finish of these repaired valves is quite up to the standard of the actual makers, and, properly used, should give long service to the user.

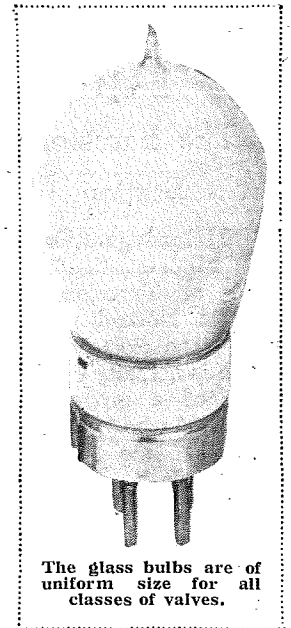

The glass bulbs are of uniform size for all classes of valves.

# Broadcast Brevities

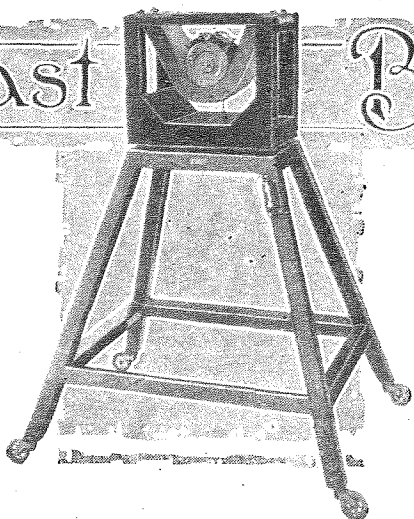

## SAVOY HILL

### No Increase in Power.

The report of the coming increase in power of certain stations can for the present be dismissed. Manchester provides the most recent case, where an increase in power to ten kilowatts is foreshadowed. No steps are being taken to alter the power of the B.B.C. main stations in the meantime.

o o o o

### Pending Daventry's Performance.

The company will, I understand, wait until the effect of the transmission from the new 3XX at Daventry has been ascertained, and until the broadcasting stations on the Continent which are to use more power than British stations have been erected. It must also be borne in mind that many wireless stations on the coast are using a maximum power of 1½ kilowatts. Even if the power of several of the broadcasting stations were only doubled, i.e., raised to 3 kilowatts, it might have a serious effect on wireless telegraph stations.

o o o o

### Room for Improvement.

There is still room for improvement in the vocabulary of wireless terms. Visitors to the B.B.C. studios have noticed a framed message on the walls to the effect that when it is necessary to refer to broadcast in the past tense, the word "broadcast" should be used, and not "broadcasted," although on one famous occasion a prominent person identified with broadcasting interests used the term "broadcasted" in public.

o o o o

### "Listener" or "Listener-In"?

Some sections of the newspaper Press retain the term "listener-in," and avoid printing merely "listener." It does, indeed, sound ambiguous to say "Listeners will hear so-and-so," when obviously what is meant is wireless listeners, or some such qualifying phrase.

o o o o

### Suggestions Wanted.

Other suggestions which have been made in substitution of the word "listener" are "audist," "inlistor," and "receptor." I think that readers of *The Wireless World* can do better than this.

o o o o

### Broadcasting of Plays.

Little need be said about the agreement between the B.B.C. and the Theatrical Managers' Association. It is recognised that during the controversy of eighteen

## TOPICALITIES.

months or more the situation has been so delicate that the broadcasting authorities have carefully refrained from taking any action which might be inimical to the theatrical interests, although it would have been possible for them to broadcast some plays without reference to the Association. Now the feeling on both sides is one of extreme thankfulness that the air has been cleared.

o o o o

### The Agreement.

The agreement itself does little beyond pave the way to negotiations over individual plays and discussions with those interested in those particular plays. Nothing is compulsory on either side, and if any serious difficulty arises at any time it will be settled by a Committee of four representatives of the theatre managers and two representatives of the B.B.C.; and the services of an arbitrator will be called into requisition if and when the necessity arises.

o o o o

### A Fitting Conclusion.

The B.B.C. are making an interesting Sunday evening experiment. They propose to wind up the Sunday transmissions on a solemn note, more in keeping with the character of the Sabbath. The line of thought is in the direction of broadcasting a hymn as a solo. On a recent Sunday evening a Station Director sang the hymn, "Nearer My God to Thee," to Carey's setting, with organ and piano accompaniment. It would be useful to know the opinions of listeners on this development. It has been suggested in some quarters that, following the lighter music of an hotel orchestra, this final item is, perhaps, too strong a contrast.

o o o o

### Outside Broadcasting.

Not every artist agrees with the intention of the B.B.C. to increase the number of outside broadcasts. A good deal of capital has been made out of the fact that artists are usually inspired by a visible audience and can adapt their performance to the apparent effect on listeners who are present in the flesh; but there is another aspect of the matter to be considered. For instance, one concert artist of international repute has declared that he prefers the solitude of the studio rather than the adulation of the crowded concert hall, and would willingly forgo the plaudits of concert-goers for the sake of the self-contentment of his artistic temperament. "I like," he says, "that 'shut-in' feeling which

## FUTURE FEATURES.

### Sunday, June 21st.

LONDON.—9 p.m., De Groot and the Piccadilly Orchestra.

BIRMINGHAM.—9 p.m., Radio Fantasy, No. 5, "Sweet o' The Year."

MANCHESTER.—2.30 p.m., Inaugural Ceremony of the Manchester and Salford Motor Lifeboat Relayed from Trafford Wharf.

### Monday, June 22nd.

LONDON.—8 p.m., Popular Classics and Drama.

BIRMINGHAM.—8 p.m., A Programme of French and Italian Music.

MANCHESTER.—8 p.m., Light Classical Music and a Play.

NEWCASTLE.—8 p.m., "Trilby."

### Tuesday, June 23rd.

ALL STATIONS (except 5XX).—8 p.m., A Midsummer Night's Dream.

### Wednesday, June 24th.

MANCHESTER.—8 p.m., The 4th Edition of "The 7.30 Revue."

NEWCASTLE.—8 p.m., Verdi and "Christopher Columbus."

GLASGOW.—8 p.m., Beethoven Masterpieces.

BELFAST.—7.30 p.m., Symphony Concert.

### Thursday, June 25th.

LONDON.—8 p.m., "Daily Graphic" Concert. S.B. to all Stations.

### Friday, June 26th.

BIRMINGHAM.—8 p.m., An Hour with the Classics.

SWANSEA.—8 p.m., 6th Aberystwyth Festival of Music.

ABERDEEN.—8 p.m., Light Opera and Musical Comedy.

### Saturday, June 27th.

LONDON.—6 p.m., Transmission from a Mine, and Popular Programme.

is so essential to the highest artistic expression. I have never got over that feeling of acute consciousness of my audience. Before the microphone, however, the spell is never broken. There, singing to an unseen audience, I have no antagonisms to fight against. That is why I prefer studio broadcasting."

○○○○

#### Wavelengths.

Official circles are considering an alteration in the wavelength of a wireless telegraph station on the South Coast. The proposal is to remove the station from its present wavelength to one some three hundred metres above the broadcast waveband. The matter has been under consideration for two years past, and the decision, when it is definitely taken, will be of the greatest importance to listeners on the South Coast.

○○○○

#### Good Work by Amateurs.

It is also understood that a number of amateurs are at present engaged in experimental day transmissions with the object of bringing the quality of daytime transmission up to the level of that of the night hours. Much useful work can, of course, be done in that direction.

○○○○

#### The Prime Minister.

A photograph of exceptional interest was taken of Mr. Baldwin in the studio on the occasion of his last broadcast. The Prime Minister is looking particularly despondent, and on studying the picture it is discovered that he is without his favourite pipe. On the wall behind him the following notice in large letters is conspicuous:—"Smoking in Studio is Not Permitted."

#### God Speakers.

On the subject of Mr. Baldwin, several letters have been received at headquarters to the effect that the voices of both the King and Mr. Baldwin can be heard much better than ladies' voices, though occasionally a particular lady is referred to as being very good. One listener suggested that the B.B.C. should persuade the Prime Minister to speak more frequently on this account.

○○○○

#### Licences.

Now that the number of receiving licences is reaching the million-and-a-half mark, the subjoined table of the progress during the past eighteen months, showing the monthly increase, is of value:—

1924.		Licences.		1924.		Licences.	
January	..	656,159	October	..	997,673		
February	..	692,556	November	..	1,082,270		
March	..	720,295	December	..	1,140,119		
April	..	770,793					
May	..	804,936	1925.		Licences.		
June	..	821,413	January	..	1,191,625		
July	..	872,548	February	..	1,311,653		
August	..	914,738	March	..	1,348,840		
September	..	998,607	April	..	1,355,778		

The simple explanation of the drop between September and October, 1924, is that the number of new licences issued during the holiday season did not equal the number of licences surrendered.

○○○○

#### Are Earlier Programmes Desirable?

The question whether earlier programmes should not be transmitted is again being raised, and requests are made for morning transmissions. I gather that headquarters do not wish to extend the general hours of transmission. Indeed, it would be possible to do so only by extensive additions to staff, and this would involve financial outlay which, if it were

available, would be better devoted to the improvement of programmes during existing hours of transmission.

○○○○

#### Nothing Like It?

During the investigations on interference on English stations which has been caused by French stations, it was discovered that an experimental station on the other side of the Channel had reduced its wavelength to a figure approximating to that of 2LO. The matter was at once taken up, and after some correspondence a polite communication was received from the French station—a comparatively new one—suggesting that as 2LO was experiencing some inconvenience would it not be better for 2LO to alter its wavelength? Some undiplomatic things were said at Savoy Hill about the cool audacity of such a suggestion.

○○○○

#### Long-Distance Reception.

A missionary on Peru Island is about to install a receiving set, and has caused enquiries to be made in London as to the most suitable type of apparatus. The nearest broadcasting station is at Sydney, 2,200 miles away.

○○○○

#### The Microphone in Big Ben.

It was recently stated in an evening newspaper that the microphone used for broadcasting the chimes of Big Ben was enclosed in a biscuit tin stuffed with straw and hay. This is not correct. Originally a carbon microphone was used inside a biscuit box filled with cotton-wool and sealed up, to make it air- and water-tight, but for the past ten months the microphone has been wrapped round with cotton-wool and enclosed in a football bladder sealed up hermetically with rubber solution to guard against the inclemencies of the weather to which otherwise it would be continually exposed in its lofty position in the clock tower at Westminster. The bladder is suspended from one of the iron rafters, approximately fifteen feet above the bells.

○○○○

#### A Prize-Winning Quartet.

The Imperial Vocal Quartet, first prize-winners at the Blackpool Musical Festival in 1924, will be making their first appearance at the Manchester Station in a chamber music programme on Sunday, June 28th. Each of the members of this quartet—Miss Hilda Roberts, Miss Lena Griffiths, Mr. William Venables, and Mr. Frank Nicholson—have fine individual prize-winning records. Their programme will include several of Brahms' Gypsy Songs, and two quartets from Liza Lehmann's "In a Persian Garden." On this occasion also, the 2ZY Piano Trio—Messrs. Eric Fogg, Don Hyden, and Sidney Wright—will be making its first appearance at the Manchester Station.

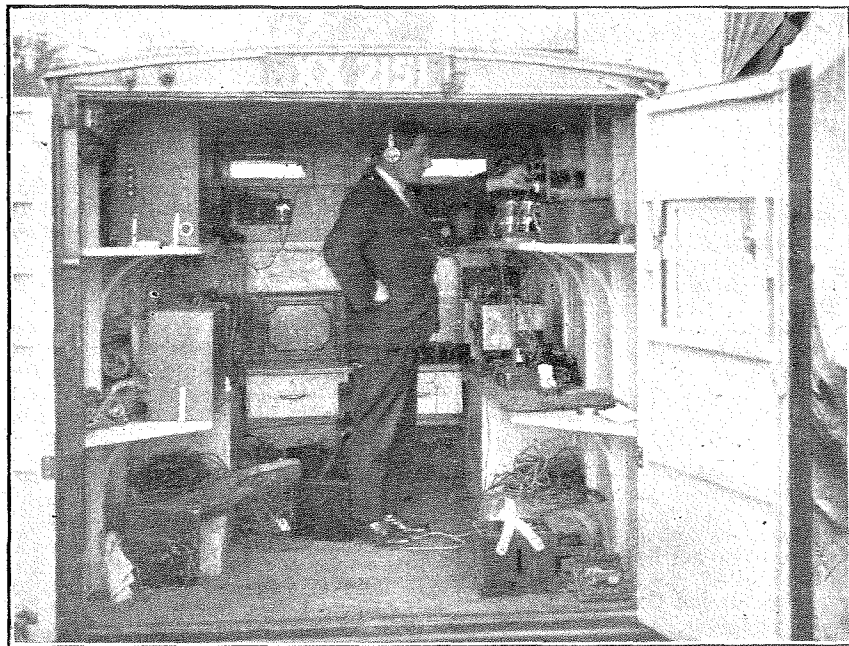

AMPLIFICATION ON A GRAND SCALE. The 18-valve Marconi set which was used by the B.B.C. on the occasion of broadcasting the ceremony of opening the Great West Road by H.M. The King on Saturday, June 6th.

# RECENT INVENTIONS

## Brain Waves of the Wireless Engineer.

### A Replaceable Dielectric. (No. 227,273.)

D. V. L. Fellows, L. V. Clark, and A. R. Pike describe in the above patent a rather interesting form of condenser. The construction of the condenser should be self-evident by reference to the accompanying diagram. It will be seen that it consists of a rigid curved plate P, which is fixed to an insulating member I, which is pivoted at X. A sheet of stiff metal foil F is also attached to I by screws S. The other end of the foil is connected to a spring H, which is attached to an arm W. An interesting feature of the invention is the use of an ordinary sheet dielectric D, which is simply held in position merely by pressure of the foil F on the plate P. The condenser is controlled by a dial fixed in the usual manner to a shaft which carries a cam C. It will be seen that as the cam is rotated it will cause the plate to approach the foil, thereby increasing the capacity. It is stated that the components of the condenser are designed so that a movement of the dial through an equal number of degrees over any part of the range causes an equal change in capacity, that is, as with the ordinary vane type. It will be observed, of course, that by altering the shape of the cam and the plate almost any desired relation between the dial movement and capacity can be obtained. Other minor details of con-

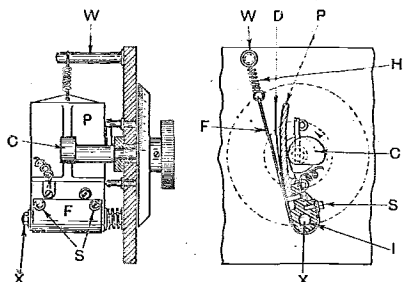

An interesting adjustable condenser.  
(No. 227,273.)

struction have not been mentioned, as they are very clearly indicated in the diagram.

### Two Four-Electrode Valves. (No. 227,364.)

The above patent, granted to F. A. L. Sloat and Rodo Patents, Ltd., relates to the use of two four-electrode valves. Readers will remember that some little while ago the use of a four-electrode

valve without a high-tension battery became very popular. This is possible by giving the grid a positive potential which tends to neutralise the effect of the space charge, which materially decreases the impedance of the valve, enabling it to operate with as low a voltage as four or six, which can be obtained merely by connection to the positive side of the filament battery. Thus, in the accompany-

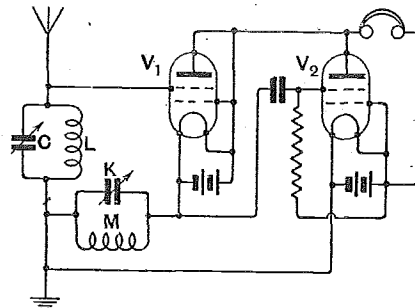

A circuit employing two 4-electrode valves.  
(No. 227,364.)

ing illustration it will be seen that this principle is applied. The circuit is exceedingly peculiar, and it is not possible, either from the illustration or from the description, to see exactly why the circuit should function in the manner described. The first valve—V<sub>1</sub>—is intended to operate as a high-frequency amplifier, while the second acts as a detector. The anode, grid and positive side of the battery are all connected together and are joined to the anode of the second valve and one side of the telephone. A tuned input circuit LC is connected between the outer grid and earth, while the negative filament of the first valve is connected to earth through another tuned circuit MK. This circuit MK is connected through a condenser and leak to the outer grid of the second valve. We cannot see that there is really any practical value in the scheme, as it necessitates the use of two filament batteries, and neither do we see what advantages there are to be gained, since by the more normal connection of two tetrodes a highly efficient dual circuit can be readily arranged and operated.

### Preventing Oscillation. (No. 213,911.)

British Patent No. 213,911, granted to The C.D. Tuska Co. and R. S. Miner, of the United States, appears to relate to an idea which we think is rather old. The invention really amounts to the use

of what may best be termed "reverse reaction." Thus the accompanying illustration shows a receiving circuit arranged according to the invention. The aerial is tuned in the normal way by a condenser C<sub>1</sub> and inductor L<sub>1</sub>, which is coupled to a grid circuit L<sub>2</sub>, C<sub>2</sub> tuned to the incoming signals. The anode circuit contains another tuned circuit L<sub>3</sub>, C<sub>3</sub>, which again is in resonance with the incoming signals. The anode circuit also contains another coil L<sub>4</sub>, which is coupled to the grid coil L<sub>2</sub>. The coil L<sub>1</sub> is arranged so that the currents passing through it tend to oppose those in the grid coil L<sub>2</sub>, or in other words, the coil L<sub>4</sub> is arranged as an ordinary reaction coil, but coupled in the wrong direction. It is stated that normally there is sufficient capacitive coupling between the circuits L<sub>2</sub>, C<sub>2</sub> and L<sub>3</sub>, C<sub>3</sub> (due to the inter-electrode capacities of the valve) to cause continuous oscillation when the two circuits are in resonance. However, since the high frequency currents in the anode circuit also pass through the coil L<sub>4</sub>, which is arranged so that it tends to oppose their maintenance, it is stated that the coil can be so arranged that its effect is exactly opposite to that produced by the capacity coupling. It is further stated that under these conditions maximum amplification and selectivity is

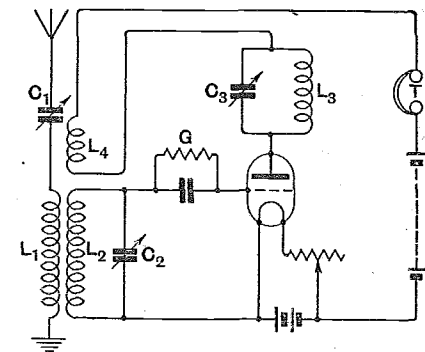

A reverse reaction method of stabilizing.  
(No. 213,911.)

obtained with excellent stability. It is interesting to note that the application for the patent was made in April, 1923, and the idea of using reverse magnetic reaction we are sure was known before that time, and accordingly it would seem that the patent is limited to the actual arrangement shown in the illustration. The scheme is also claimed for a high frequency amplifier, the arrangements shown in the illustration being, of course, for a detector valve.

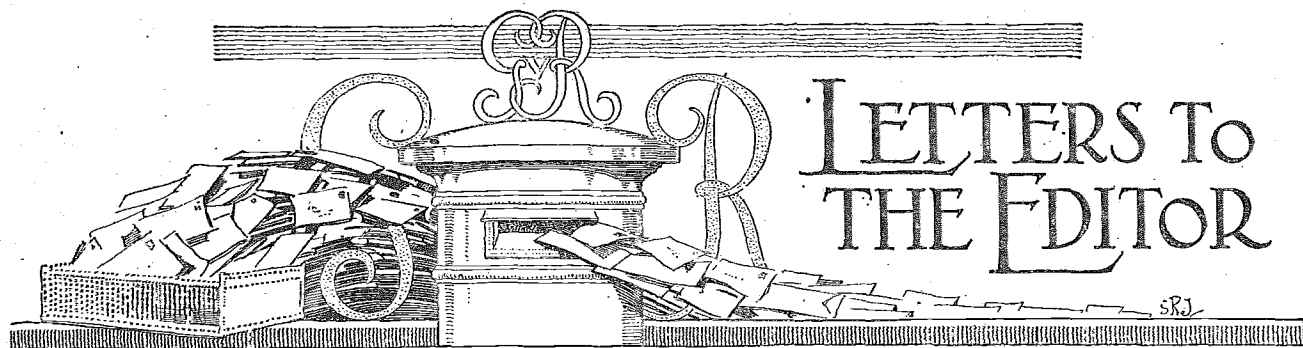

# LETTERS TO THE EDITOR

The Editor does not hold himself responsible for the opinions of his correspondents.

Correspondence should be addressed to the Editor, "The Wireless World," 139-140, Fleet Street, E.C.4, and must be accompanied by the writer's name and address.

## INTERFERENCE WITH OSLO.

Sir,—I was very interested to learn, per "Current Topics" of *Wireless World* of May 13th, that Oslo is heard very strongly in the Glasgow district.

Ever since this station commenced working on 380 metres—until two or three weeks ago—I also regularly received its transmissions at great strength.

Unfortunately, since two or three weeks ago another Continental station broadcasting on a wavelength just below Oslo's has greatly spoilt the transmission. The newcomer apparently is the station that was previously working on about 388 to 390 metres, and even then made a fearful noise often at great strength.

Who is this jammer of Oslo? Is it Radio-Lyons?  
Sheffield.

A. R. BURTON.

## H.T. BATTERY CONNECTIONS.

Sir,—With regard to the suggestion by "R.E.A." in the "Readers' Ideas" section of *The Wireless World* for May 20th, I have been using three 36-volt units in the same way and consider it the only really economical method, in spite of the slightly higher cost of the smaller units. My valves are each supplied with a multiple of 36 volts, as follows:—

H.F. Mullard D.3 H.F., 72 volts.

Detector Cossor W.1, 36 volts.

L.F. (first) Marconi D.E.R., 72 volts.

L.F. (second) Marconi D.E.6, 108 volts.

I cannot agree, however, with your contributor when he advocates changing over the connections to secure even discharge of all the units. In my own case this would mean that all three units would require simultaneous replacement, causing an inconveniently heavy discharge of my slender purse, especially as I am using large capacity batteries. I shall find it much better, as well as less trouble, to replace one at a time, having had similar experience with motor cycle tyres.

Incidentally, I do not see how accumulator H.T. can be satisfactorily used otherwise than by this method, since an unevenly discharged multiple-cell accumulator demands more careful treatment than it is likely to get at many charging stations, besides being uneconomical for the same reason as that applying to a dry cell battery.

ROBERT A. IRVING.

Carlisle.

## RECEPTION ON 20 METRES.

Sir,—It may be interesting to your readers to hear of some experiences on the wavelengths around 20 metres.

On Sunday, May 10th, A2CM was heard at fair strength working G2OD. On the following Sunday A2CM was heard rather louder, the time on each occasion being between 0600 and 0800 BST. On the morning of May 19th, M1AA was heard sending CQ on 22 metres, and later was badly jammed by G2OD, both stations being about the same strength.

The next morning, May 20th, A2ME was heard at 0700 and 0720 BST about R4; on May 22nd MIB was heard sending CQ, and test on 20 metres at 0640 and again at 0657, calling NZ. Later A2ME was heard, and he transmitted for about 15 minutes, giving his address as 97, Clarence Street, Sydney.

It will be noticed in the May 20th issue of *The Wireless World* Mr. J. Gordon Ritchie suggests that the 20-metre signals might only have to leave the transmitting station in daylight, but on studying the above reception times it will be seen that the Mexican signals actually left the transmitter about midnight, and must have travelled the first half of the distance in darkness. This contradicts the theory of signals starting in daylight to cover great distances.

The circuit used is one described in *The Wireless World* some months ago, using regenerative detector and one LF. The valves used are Marconi DER for detection, and DE6 for amplifying. The detector is of the four-pin type.

The aerial coil has 3 turns, the secondary 2, and the reaction 4, all of 4in. diameter, and supported only by cotton thread.  
Chiswick, W.4. H. AND L. WILKINS (G2BAO).

## THE WEST LONDON WIRELESS AND EXPERIMENTAL ASSOCIATION.

Sir,—I should like it to be known that this Association has not terminated. This session, the meetings have been held regularly on the first and third Thursdays of each month, when members have held discussions respecting their various achievements, especially the reception of 20-metre wave Morse signals from amateurs in New Zealand and Australia during the hours of daylight. All the meetings have been informal, in accordance with the wish of the members present at our last annual general meeting.

I shall be pleased to hear from any gentleman who is desirous of joining the Association.

HORACE W. COTTON, Hon. Sec.

Hayes, Middlesex.

## CALIBRATIONS ON HARMONICS.

Sir,—The new transmitting permits issued by the G.P.O. forbid the use of interrupted continuous wave. This is all to the good. Meanwhile GGB (Aldershot) has changed from its wobbly CW to ICW and has developed a very complete series of harmonics. Whenever he is working it is possible, over a large area, to hear his 10th to 15th or even higher harmonics. These are useful for calibrating receiving instruments with a range between 50 and 200 metres, since he is fairly accurately tuned to 1900 metres. They may have other uses, but for the moment I cannot think of any.

ERNEST H. ROBINSON (5YM).

Pirbright, Surrey.



# Readers' Problems

Readers Desiring to Consult "The Wireless World" Information Dept. should make use of the Coupon to be found in the Advertisement Pages.

### Obtaining High Quality Without the Use of Power Valves.

It not infrequently happens that readers are desirous of constructing a set capable of giving a large volume of sound coupled with high quality reproduction from the loud-speaker, but they do not care to go to the expense of purchasing a power valve for the final stage of the amplifier, since the price of a power valve is still in the neighbourhood of the price of two valves of the ordinary type. The use of an ordinary "R" type valve in the second stage of an L.F. amplifier is almost certain to produce distortion, owing to the relatively small amount of "straight line" portion of characteristic curve available. The use of a power valve of course removes this difficulty, but there is another method of overcoming this difficulty without utilising an expensive power valve, which is not as often used as it might be. This is by using two ordinary type dull or bright emitter valves in the final stage, connected in the method known under the name of "push-pull."

A suitable circuit is given in fig. 1, from which it will be seen that two special transformers are needed, one an intervalve transformer with a central secondary tap, and the other an output transformer of one to one ratio with a centrally tapped primary. No additional apparatus is necessary, and since these

transformers are now obtainable from reputable firms at a price not exceeding that of an ordinary intervalve transformer, the circuit is well worth while adopting. Telephones or loud-speakers of the ordinary conventional type and resistance are used, of course, whilst the circuit is equally suitable for bright or dull emitters. Although not shown in the circuit, switching may be incorporated in a very simple manner, in order to cut out the last stage when not desired, and of course an amplifier of this type is suitable for incorporating in or adding as an additional unit to any type of receiving set.

o o o o

### Connecting Valve Filaments in Series.

A CORRESPONDENT who has been using a six-valve set of the super-heterodyne type recently connected the filament circuits of all six valves in series in order that he might use six one-volt "peanut" valves in conjunction with a six-volt accumulator in order to effect an economy in filament current.

He finds that the receiver functions quite satisfactorily in this manner when receiving stations within a reasonable range, but that he is not able to obtain the extreme ranges which he formerly obtained, owing to the fact that he is no longer able to secure the delicate control over the filament emission of the inter-

mediate amplifying valves, by reason of the loss of separate filament current control for these valves. He has tried the effect of fitting a master rheostat, but finds that no useful effect is obtained, since an alteration in the filament temperature of the intermediate valves means an alteration in the temperature of the oscillator and detector valves.

When several valves are connected in series in the manner described, filament temperature control may be secured by shunting a portion of the filament current through a resistance connected across the filament, the actual amount of current diverted from the filament depending upon the setting of this adjustable resistance. In the particular case mentioned, a variable resistance should be connected in shunt with the filaments of all three intermediate valves.

o o o o

### Constructing an Efficient 2 H.F. Set.

IN receivers of the type having two high frequency stages, it is usually a matter of very great difficulty to successfully stabilise the H.F. valves, they being prone to oscillate continuously, even though no reaction is used in the set, owing to the energy fed back through the capacity between the actual valve electrodes and in the capacity existent in the valve holder and in the associated wiring. Various expedients are used to counteract this tendency to oscillate, one of the most frequently used being potentiometer control of the grids of the H.F. valves, stabilisation being effected by permitting the passage of a small amount of grid current to flow.

Another method is to reverse the reaction coil, thus applying negative reaction; other methods being to bring damping plates into the vicinity of the H.F. transformer or tuned anode coil windings as the case may be, or even shunting the windings of these components with a resistance.

All the foregoing methods are fundamentally unsound, inasmuch as they depend for their action on introducing losses into the circuit; it being necessary that these losses be made sufficiently serious to cause a cessation of oscillation. Obviously the correct method is to attack the trouble at its source and remove the cause of the instability, namely, the stray capacity we have mentioned.

One of the most successful methods of

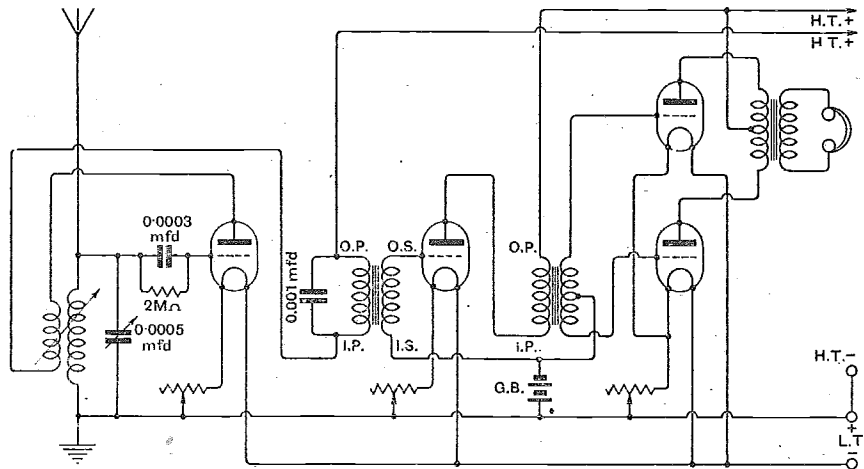

Fig. 1.—A receiver with valve detector, one stage of ordinary low-frequency amplification followed by a "push-pull" amplifier.

doing this is undoubtedly the neutrodyne system, whereby a small balancing capacity is used to counteract the effect of the capacity existing between the valve electrodes and their associated wiring. Whilst this method is productive of excellent results, it suffers from the disadvantage of confining a receiver using it to a limited band of wavelengths, it not being feasible to make use of the plug-in type of inductances and transformers to cover all wavelengths; a fact which is a serious drawback in the eyes of the average set user in this country. It is possible, of course, to construct two or three sets of neutrodyne transformers for various bands of wavelengths, but this by no means gets over the difficulty, since the set will require re-neutralising for every change of transformers, thus rendering a quick change of wavelength impossible.

A further method of using two H.F. stages efficiently, which has been greatly neglected by set constructors, is to design an instrument capable of responding to any wavelength by means of interchangeable inductances and transformers, in which the most meticulous care has been taken to eliminate all stray capacity effects. Many readers attempt to do this by employing anti-capacity valve holders, carefully spacing the wiring, making grid and plate leads as short as possible, etc., but meet with no success because they do not tackle that portion of the circuit in which probably the bulk of the capacity exists, namely, the valve. In the ordinary four-pin type of valve the capacity in the "pinch" of the valve, in which are embedded the filament, plate and grid leads in very close proximity, is fairly high, and it is of little use to eliminate capacity in the associated wiring if valve capacity is permitted to remain. It is, however, possible to obtain valves of the anti-capacity type, in which the grid and plate leads are brought out at opposite ends of the valve, and provided valves of this type are used, and great care taken to eliminate stray capacity in the wiring, it is possible to construct a 2 H.F. set which is really stable. No reaction will need to be included in the set, since it will be found that oscillation can be produced when the potentiometer slider is at the extreme negative end, whilst quite a small movement towards the positive end will cause a cessation of oscillation, thus giving a very delicate control over regeneration.

o o o o

**An Easily Tuned Three-valve Set.**

MANY readers from time to time indicate their desire to construct receivers capable of responding to the B.B.C. band of wavelengths and to the wavelengths of most of the Continental stations, without resorting to the use of plug-in coils, but they are confronted with the high price of the components necessary to achieve this object, and wish to construct the aerial and anode inductances themselves. This can readily be done, and, furthermore, these inductances can be constructed so that variable condensers are superfluous and the operation of the instrument is reduced to the

**BOOKS FOR THE WIRELESS STUDENT**

*Issued in conjunction with "The Wireless World."*

"THE PERRY AUTO-TIME MORSE SYSTEM" by F. W. PERRY. Price 6d. net. By Post, 7d.

"MAGNETISM AND ELECTRICITY FOR HOME STUDY" by H. E. PENROSE. Price 6/- net. By Post, 6/6.

"THE ELEMENTARY PRINCIPLES OF WIRELESS TELEGRAPHY" by R. D. BANGAY. Price per part, 4/- net. By Post, 4/5. In one volume 7/6 net. By Post, 8/-.

"THE OSCILLATION VALVE—THE ELEMENTARY PRINCIPLES OF ITS APPLICATION TO WIRELESS TELEGRAPHY" by R. D. BANGAY. Price 6/- net. By Post, 6/3.

"ELECTRONS, ELECTRIC WAVES AND WIRELESS TELEPHONY" by J. A. FLEMING, M.A. Price 7/6 net. By Post, 8/-.

Obtainable by post (remittance with order) from **ILIFFE & SONS LIMITED** Dorset House, Tudor St., London, E.C.4 or of Booksellers and Bookstalls

utmost simplicity, even though an H.F. valve is used. The inductances, fig. 2, should be so arranged that one switch arm is used to vary the number of turns in use by one turn at a time, the remaining switch arm being used for coarse tuning. For instance, in order to cover the B.B.C. band of wavelengths, the aerial inductance could consist of 56 turns of No. 22 D.C.C. wound on a former 3 inches in diameter, a tapping being taken from every seventh turn up to a total of seven, these seven tappings being taken to one set of studs, the remaining seven turns being tapped at every turn and taken to the remaining set of studs. In this manner any number of turns between 1 and 56 could be brought into the aerial circuit, thus giving a very fine adjustment. The anode inductance could be similarly constructed, with the exception that a larger number of turns would be needed, owing to the fact that the inductance and capacity of the aerial system would not be added to this coil as in the case of the aerial coil. By the provision of a small variable condenser con-

nected between the anode of the detector valve and the aerial terminal, regenerative effects can be obtained and oscillation produced if desired.

o o o o

**An H.F. Transformer for the B.B.C. Wavelengths.**

A READER who is constructing a four-valve receiver for the broadcast band of wavelengths and is intent on constructing all the components himself is in difficulties concerning the design of the H.F. transformer. This instrument is to be permanently incorporated into the set, and is not to be of the "plug-in" type. It is to be tuned by a .00025 mfd. variable condenser connected across the primary winding.

The primary of the instrument may be solenoid wound on to an ebonite former 2½ inches in diameter, and can consist of 75 turns of No. 22 D.S.C. This can be covered by a layer of empire cloth, then the secondary consisting of an equal number of turns of similar gauge wire can be wound over it. Many readers prefer to tune the secondary winding and to make the primary with a less number of turns in order to increase selectivity. If this is done it is well worth the slight extra trouble and expense to include a neutralising condenser tapped between the grid of the H.F. valve and a suitable point on the secondary winding.

o o o o

**Experimenting with a Two-Electrode Valve.**

A READER wishing to experiment with a two-electrode valve as a rectifier desires to know if there is any method whereby an ordinary triode valve may be used for this purpose.

This is quite possible: all that need be done being to join the grid and plate legs of the valve. The combined grid and anode is then treated as the anode of the two-element valve, the other element being, of course, the filament.

With the grid and plate connected in this manner the impedance of the valve will be less than that when the valve is used in the ordinary way. The impedance will, of course, depend on the construction of the valve and the value of the plate voltage employed.

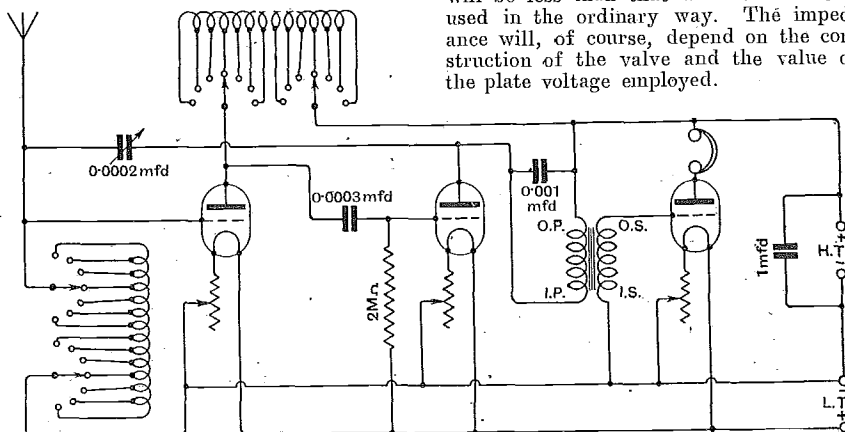

Fig. 2.—An easily tuned three-valve receiver

# The Wireless World

## AND RADIO REVIEW

No. 306.

WEDNESDAY, JUNE 24TH, 1925.

VOL. XVI. No. 20.

Assistant Editor:  
F. H. HAYNES.

Editor:  
HUGH S. POCOCK.

Assistant Editor:  
W. JAMES.

Editorial Offices: 139-40, FLEET STREET, LONDON, E.C.4

Telephone: City 4011 (3 lines).

Advertising and Publishing Offices: DORSET HOUSE, TUDOR STREET, LONDON, E.C.4

Telephone: City 2847 (13 lines).

Telegrams: "Ethaworld, Fleet, London."

COVENTRY: Hertford Street.

BIRMINGHAM: Guildhall Buildings, Navigation Street.

MANCHESTER: 199, Deansgate.

Telegrams: "Cryolst Coventry."  
Telephone: 10 Coventry.

Telegrams: "Autopress, Birmingham."  
Telephone: 2970 and 2971 Midland.

Telegrams: "Hiffe, Manchester."  
Telephone: 8970 and 8971 City.

Subscription Rates: Home, £1 1s. 8d.; Canada, £1 1s. 8d.; other countries abroad, £1 3s. 10d. per annum.

As many of the circuits and apparatus described in these pages are covered by patents, readers are advised, before making use of them, to satisfy themselves that they would not be infringing patents.

### THE B.B.C. AND DISTANT RECEPTION.

ONCE again the question has been raised of whether the popularity of the B.B.C. might not be considerably enhanced if arrangements were made whereby each broadcasting station should, in turn, close down for some period to enable listeners in the vicinity to attempt to receive distant transmissions.

A correspondent in a recent issue of the *Radio Times* has suggested that the B.B.C. should allow all stations to close down for one day each month, *i.e.*, on a different day of the week. Valve users would then be relieved of interference from the local station and be able to test their sets for distance. The interests of crystal set users would not be seriously interfered with, for it is pointed out that, with the local stations quiet, they would stand a fair chance of hearing other stations, whilst Chelmsford would be audible to most of them on the longer wave.

#### Public Interest in Distant Stations.

The B.B.C. should not ignore the fact that there are thousands of listeners who are interested in hearing stations other than their local one, and this enjoyment is practically denied them at present, more especially now that the programme of the B.B.C. stations frequently extends until after most of the Continental stations have closed down. Those who have a Super-heterodyne or other type of ultra-selective receiver are not, of course, so seriously concerned with the "swamping" effect of their local station, but these fortunate

individuals are distinctly a minority amongst the wireless listeners to-day.

#### A Case for Action by the B.B.C.

We would urge the B.B.C. to consider this question seriously and take early steps to provide some period of quiet when each area is free from the transmission of the local station. We know that the policy of the Broadcasting Company is to encourage listeners to concentrate on their local stations only and to ignore the attractions of distant reception, but if, as Capt. Eckersley assures us, distant stations are not worth listening to because of interference and loss of quality, then the surest way which he can adopt in order to prove it, is to enable listeners to try for themselves. If, after such an experiment has been carried out, it is found to be unpopular and the majority clamour for the resumption of their local transmissions on those evenings, then it will be a simple matter to return to the old order of things; but if, on the other hand, the experiment is received with enthusiasm and listeners are prepared to overlook some loss in quality in the interest of picking up

foreign stations and distant stations of the B.B.C., then the company will have the satisfaction of knowing that it has taken one more step in the direction of satisfying the wishes of its listeners. After all, the governing concern of the management of the B.B.C. should be to give the utmost enjoyment to the listener, and it is for the listener to decide if the reception of distant stations provides an attraction or not.

### CONTENTS.

	PAGE
EDITORIAL VIEWS ... ..	629
THE QUARTZ OSCILLATOR ... ..	630
By Prof. E. Mallet and V. J. Terry.	
FIRST RADIO EXHIBITION IN HOLLAND	637
GENERAL PURPOSE RECEIVER ... ..	639
By N. P. Vincer-Minter.	
CURRENT TOPICS ... ..	645
READERS NOVELTIES ... ..	647
THE WORK OF A WIRELESS ENGINEER	649
By Dr. W. H. Eccles, F.R.S.	
VALVES WE HAVE TESTED ... ..	652
BROADCAST BREVITIES ... ..	653
AERIALS AND LIGHTNING ... ..	655
By John Citizen	
NEW APPARATUS ... ..	657
LETTERS TO THE EDITOR ... ..	658

# THE QUARTZ OSCILLATOR.

## A New Wavelength Standard.

By Prof. E. MALLET, M.Sc., M.I.E.E., and V. J. TERRY, B.Sc., A.C.G.I.

IT is well known that if an oscillatory circuit is coupled with a source of alternating current, such as a valve oscillator, the frequency of which can be varied, then when the frequency of the source is the same as the natural frequency of the oscillatory circuit, large currents will flow in the latter and they will produce by their reaction a marked electrical effect on the source. In fact, in the case mentioned, the valve oscillator may actually stop oscillating. This can be detected by any suitable means, such as a milliammeter in the grid or plate circuit, or the production of a click in a pair of telephone receivers, and the arrangement thus constitutes a frequency measuring device. For if the natural frequency of the oscillatory circuit is known the valve oscillator can by these means be set to generate oscillations of approximately that frequency.

Such an arrangement, however, has its drawbacks. The indications are not very sharp, and the oscillatory circuit will not remain quite constant, perhaps, from day to day.

A similar device can be used for low frequencies, using a tuned reed or tuning fork as the "oscillatory circuit." A coil wound round a bundle of iron wires acts as an electro-magnet to actuate the fork, and when the current through the coil has the frequency corresponding to that of the fork, the reaction of the latter on the coil is a maximum, and the effective impedance of the coil is altered very considerably. Settings of low frequency oscillators obtained in this way are very precise, and can readily be made to one part in 50,000. The shorter the fork, the higher the frequency, but a fork for wireless frequencies is quite impracticable—at least, it was so until its equivalent was produced. Its equivalent, that is, from the point of view that mechanical vibrations and mechanical resonance are used to influence an electrical circuit. We refer to the quartz crystal.

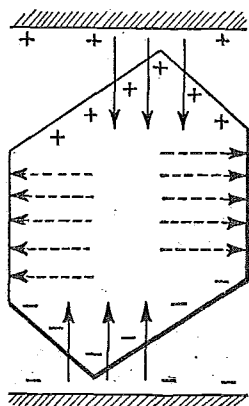

Fig. 1.—Explaining the action of the crystal.

B 2

### Piezo-electric Effect and Resonating Quartz Crystals.

The quartz crystal, which has attracted considerable interest of late as a frequency standard, and which we owe to Professor W. G. Cady, of the Wesleyan University, Connecticut, depends for its action on what is known as the piezo-electric effect.

Though many crystals exhibit this property, none is so well suited for use as a frequency standard as natural quartz, with its great mechanical strength and freedom from deterioration.

A slice or section from a quartz crystal is taken at right angles to its length (along the optical axis) to obtain an irregular hexagonal plate, and if this is placed between two electrodes, between which is established a potential difference, the crystal becomes shortened (absorbing from the electrodes part of their charge), or lengthened in the direction of the full line arrows in Fig. 1.

Just as a piece of indiarubber, when pressed in one direction, squeezes out all round, so the quartz crystal, when placed in the electric field between the two electrodes, if shortened in the direction of the full line arrows, is lengthened in the direction of the dotted arrows. When we reverse the sign of the potential difference between the electrodes all the effects are reversed too.

The piezo-electric phenomena are "reversible"; that is to say that, as an electric field alters the size of the crystal, so an alteration in the size of the crystal produces an electric field in the crystal. Squeezed in the

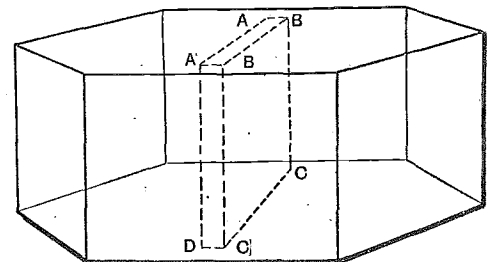

Fig. 2.—Method of cutting resonator plate from a natural quartz crystal.

direction of the full line arrows, or pulled in the direction of the dotted ones, the faces marked with the plus and minus signs acquire charges of those signs. In short, an electric stress produces a mechanical strain, and *vice versa*.

It should, of course, be understood that these electric charges are very small, and the changes of size microscopic. This effect was discovered by the Curie brothers.

From our slice of the natural crystal, which is somewhat inconvenient in shape, a little rectangular bar is cut, as in Fig. 2, length BB, thickness AB and width BC. The faces BCC and AADD will be recognised as those facing the electrodes, which may either be of tinfoil stuck on to the crystal or of sheet metal about 0.2 mm. or less away from the faces thereof.

The photograph (Fig. 5) shows one such quartz crystal and a box for it, whose sides of brass form the electrodes. Another is shown within its box.

Any bar of elastic material is capable of longitudinal vibration, so that if a bar of iron resting on a wooden

**The Quartz Oscillator.—**

bench squarely on the end is hammered, it emits besides a large amount of clanging noise a perfectly definite musical note, and the same note may be obtained, though of a different and more unpleasant quality, if the bar is held firmly at its centre between clamps of wood in a

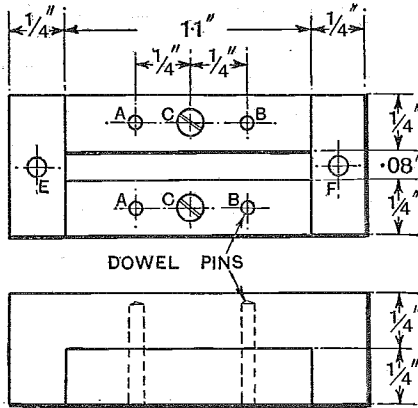

Fig. 3.—Details of the mounting for a crystal resonator.

vice, and one's hand (previously dusted with resin) is drawn longitudinally over it.

In these vibrations the bar is extended slightly and overshoots the normal position when it returns, becoming too short, and then, as it lengthens again, it overshoots the mark once more, and so on. The time which elapses after passing through the normal length before it attains that dimension again is fixed, being equal to half the "periodic time." It depends upon the material of the bar, and is inversely proportional to its length.

The density and modulus of elasticity of a quartz crystal are such that a piece of crystal 2.7 mm. long has a periodic time of  $10^6$  sec., or a natural frequency of one million, which corresponds to a wavelength of 300 metres. The wavelength is approximately equal to  $1,100 \times$  length in cms.

A quartz crystal between suitable electrodes, to which is applied an alternating voltage of its "natural fre-

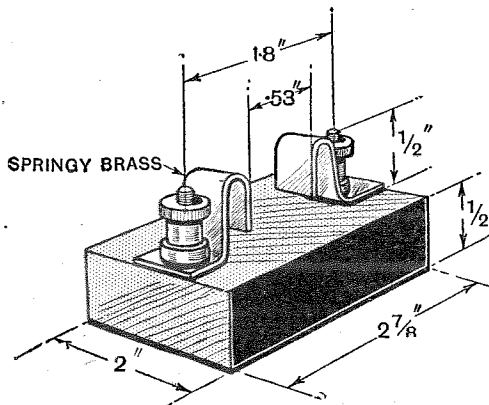

Fig. 4.—The clip used to hold the interchangeable crystal box.

quency," is in resonance, and lengthens and shortens (or vibrates) to a very much greater degree than it would with any other frequency. The charges it absorbs under these conditions are correspondingly large, or, in other

words, it passes a much larger current, and has a far greater reaction effect on the source supplying the voltage.

**Mounting Crystals.**

We will now give practical details for mounting such a crystal resonator.

The crystals themselves may be obtained to order from Messrs. Adam Hilger, at a cost of less than £1 each.

The dimensions given in Fig. 3 are suitable for a crystal 2.5 cm. long (2,700 m. approx), 0.5 cm. wide and 0.15 cm. thick. The total air gap is about 0.5 mm., and may be much reduced if desired.

To start, procure a piece of 1/4 in. square brass and cut off two pieces 1.1 in. long (which allows about 2 mm. end clearance), and drill 3 holes on the centre line of each, spaced 1/4 in. apart: the outer pair about 0.075 in. diameter, the other 8 BA clearance (0.09 in.) and countersunk. Next take a piece of ebonite 1/2 in. thick  $\times$  0.6 in.  $\times$  1.6 in., and cut a groove 1.1 in. wide and 1/4 in. deep across it. (This is done preferably with a milling or shaping machine,

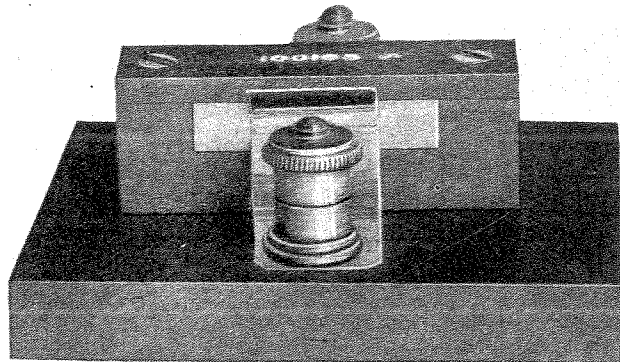

Fig. 5.—A mounted quartz crystal.

but if they are not available make a saw cut down each side and file out the middle portion.) Drill and tap the centre hole for one electrode and screw it on. Then, using the brass as a jig, drill through the ebonite holes A and B with the same drill as was used before. This drill should be chosen about 0.001 in. smaller than a convenient sized piece of brass wire, which is emery-papered down to size and forced in through brass and ebonite. Next take a piece of metal 0.08 in. thick. Place it between the electrodes (where the crystal is to be), press the second electrode up against it, and drill and tap its centre hole and proceed as before with the other two holes and dowel pins. This device ensures a uniform gap if the metal spacer is truly flat and of constant thickness.

There now remain the other pair of holes, E and F, to be tapped 8 BA and the lid (3/8 in. thick) fitted with countersunk screws. At this stage the box should be rubbed down on a piece of emery paper resting on a flat surface, until the brass and ebonite

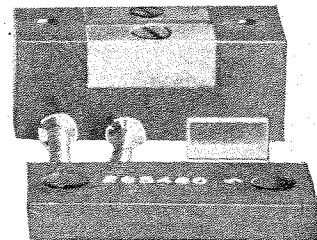

Fig. 5a.—Another view of the crystal, the top being removed.

**The Quartz Oscillator.—**

of the sides is perfectly smooth and level. In drilling and tapping ebonite, oil is necessary to prevent it "burning." When, therefore, the box is finished, each part should be marked to facilitate reassembling, and the whole taken to pieces and carefully cleaned.

The next sketch (Fig. 4) shows the clip to hold the interchangeable crystal boxes. The base is of 1/2 in. ebonite recessed to take the nuts of the terminals. The brass clips should be of spring brass about 0.015 in. thick, which is sufficient to give a good firm contact without fear of deforming the crystal box. If the intention of the holder is to use short-wave standards, which (for reasons

H. F. GENERATOR

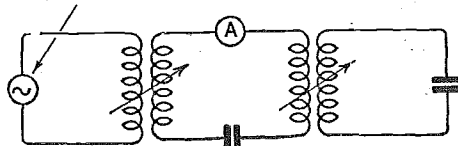

Fig. 6.—A circuit having a resonance curve such as that of Fig. 7.

which will appear later) is not necessary, then the brass clips should be reduced to about the length of the shortest crystal.

**Wavelength Standard: Various Methods of Use with Curves.**

Everyone is familiar with the form of resonance curve shown in Fig. 7, obtained from a circuit of the type shown in Fig. 6, when the frequency of the high-frequency generator is varied and the two circuits are tuned. We obtain a similar result when the two circuits are coupled by a common condenser (see Fig. 8).

Now if, instead of using the second electrical resonant circuit in Fig. 8, we place a quartz resonator across the condenser C in place of L<sub>2</sub> and C<sub>2</sub>, as shown in Fig. 9, we obtain an exactly similar curve, except that the centre

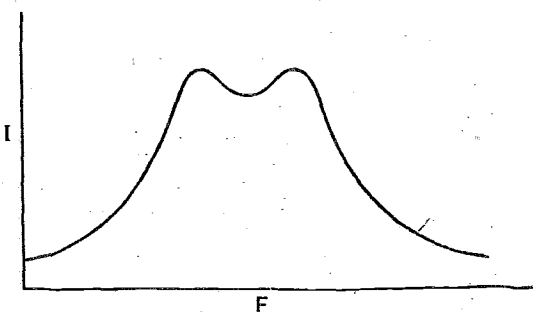

Fig. 7.—Resonance curve for a coupled circuit, such as that of Fig. 6.

of the resonance curve dips far more rapidly. If the electrical circuit is tuned exactly to the natural frequency of the crystal, the centre of this dip in the curve or "crevasse," as Prof. Cady called it, indicates the natural frequency of the crystal.

Even if the electrical circuit is not tuned to this frequency, the centre of the crevasse is still very nearly at the natural frequency of the crystal (nearly enough for all ordinary purposes).

A copy (Fig. 10) of such a resonance curve obtained by means of a recording apparatus developed by the

authors and Mr. E. H. Harding, B.Sc., A.C.G.I., is shown to give an idea of the sharpness of the "crevasse." The actual details are given in Fig. 11.

The current from the high-frequency generator is of constant magnitude and variable frequency, and it will be noticed that, instead of measuring the current in the

H. F. GENERATOR

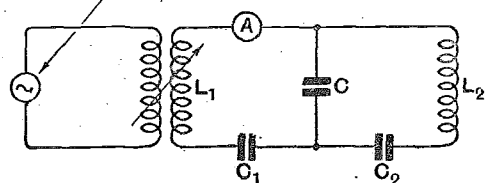

Fig. 8.—A capacitatively coupled circuit.

resonant circuit, we measure the voltage across the coil, and, since  $V = 2\pi fLi$ , this is a measure of the current  $i$ . The wavelength at the centre of the crevasse is 1,130 metres ( $F = 265,480 \sim$ ), and the marks at each side represent frequencies 0.5 per cent. above and below this, i.e., 204,153 and 266,807 cycles per second respectively.

In Fig. 10, curve (1) is the simple resonance curve without the crystal, (2) the curve obtained with the crystal.

It should be noticed that the stray capacity of the crystal box has altered the tuning of the circuit slightly.

It will be noticed, too, that the circuit chosen was un-

H. F. GENERATOR

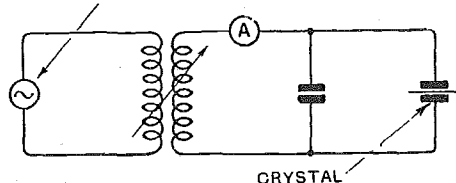

Fig. 9.—A crystal resonator connected to the circuit of Fig. 8 in place of C<sub>2</sub>L<sub>2</sub>.

usually proportioned in having a very large capacity and small inductance. Had the inductance been larger, the reduction of amplitude at the centre of the crevasse would have been still greater.

The method just described is that favoured by the originator, Prof. W. G. Cady, but there are other methods of using these standards.

For the simplest of these we have an oscillator, the output from which is passed through an amplifying valve with a large characteristic resistance (such as an R valve) to a high impedance, Z, about 6,000  $\omega$ . The crystal is in parallel with Z (see Fig. 12). For the higher frequencies, Z may be a very high inductance with a shunt

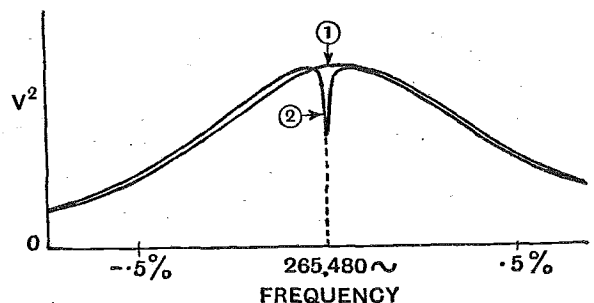

Fig. 10.—Resonance curve obtained from the circuit of Fig. 9.

**The Quartz Oscillator.—**

capacity, so that the natural period of the circuit is well below that of the crystal, and for lower frequencies the coil should have a natural frequency well above that used; in fact, any impedance that is far from resonance may be employed. When the frequency of the oscillator is

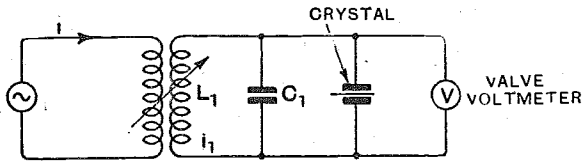

Fig. 11.—Circuit used to obtain the resonance curve.

varied through the resonant frequency of the crystal, the voltage varies, as shown in Fig. 13. The resonant frequency is exceedingly near to the intersection of the dotted and full lines. This method defines the frequency more accurately than any other using the ordinary crystal resonator, since the point desired is defined by two lines intersecting nearly at right angles, and has the additional advantage that there is no need to tune another circuit to the same frequency, which is not easy unless the frequencies are approximately known beforehand. Even with this second method, the resonance is so sharp that unless the oscillator frequency is varied very gradually and the galvanometer of the valve voltmeter very respons-

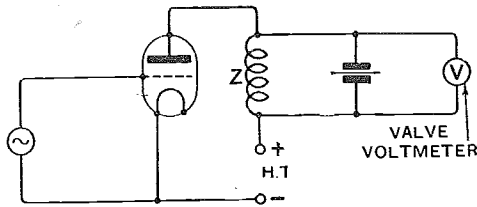

Fig. 12.—Another method in which a valve is used.

ive, one is apt to miss the voltage changes. There is, however, a very interesting way of overcoming this difficulty. A pair of phones is placed in series with the anode battery of the valve voltmeter, and the oscillator condenser varied very rapidly. As the crystal frequency is passed, the crystal vibrates and remains vibrating at its natural frequency for a small fraction of a second afterwards, owing to its low decrement, and in doing so produces on its electrodes an alternating voltage of constant frequency. Meanwhile, the oscillator frequency changes sufficiently to produce a beat note, which rises in pitch until it dies away as the oscillator frequency changes. Once the crystal's wavelength has been located in this

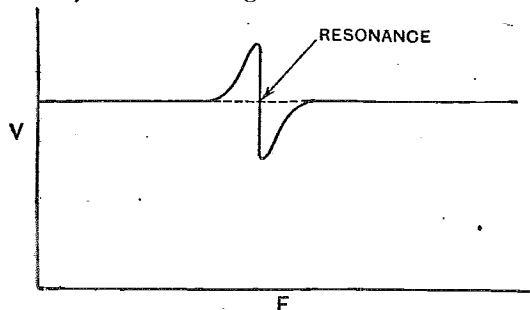

Fig. 13.—The change in voltage across the circuit of Fig. 12 when the frequency of the oscillator is varied.

way, there is very little difficulty in finding its value accurately with the voltmeter.

There is another method simpler to use, but not giving quite the same precision. The crystal is placed across the resonating circuit of a valve oscillator, as shown in Fig. 14, preferably of the tuned grid type, and the reaction coil moved away until the oscillator is operating feebly. When the condenser is varied and the resonant circuit is tuned in to the crystal frequency, the damping of the

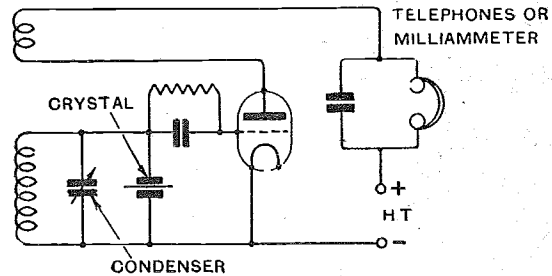

Fig. 14.—Another method in which the crystal is placed across the grid circuit of a valve oscillator.

circuit is vastly increased, the oscillator stops, and a click is heard in the phones. Moving the condenser either way causes the oscillator to start up, when a second click is heard. The natural frequency of the crystal is half way between the two frequencies at which clicks occur. The clicks become closer and closer as the coupling of the reaction coil is increased, until they disappear.

Suppose, in the above method, we were to couple the oscillator coils much tighter, so that it does not cease to function, and vary the tuning through a range of frequency, including that of the crystal, then the variation of condenser reading and frequency will be as below shown in Fig. 15. Over a small range of capacity the frequency hardly changes at all, and over this range the wavelength corresponds very nearly to the natural fre-

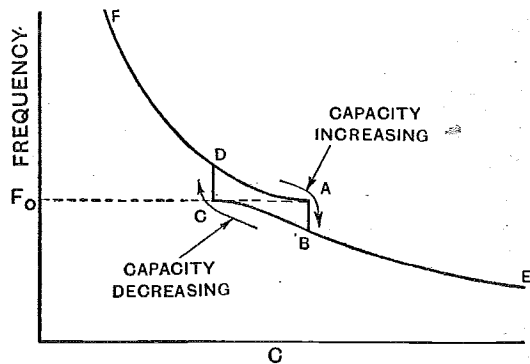

Fig. 15.—The variation of frequency with capacity.

quency of the crystal. Strangely enough, the exact value of the latter is not obtainable, for suppose we start with the condenser at its smallest value and increase the capacity, then the frequency descends the curve by the path FDA, and from A drops suddenly to B and continues on to E. Should we then reduce the capacity, it returns by the path EBC, and from C rises suddenly to D. The exact frequency of the crystal is midway between the points C and A, but the range of frequency from C to A is very small indeed.

**The Quartz Oscillator.—**

To use an oscillator in this way, first locate the frequency of the resonator by the method mentioned just previously, set another oscillator to produce with it an audible beat note, and then vary the tuning of the oscillator having the crystal in its resonant circuit very slowly. As we approach the D to A part of the curve, the note varies very slowly and then gives a sudden alteration of pitch as the frequency falls from A to B. The same thing then takes place if we tune each along the BCD part of the curve.

**The Crystal Valve Oscillator: Circuits and Practical Details.**

There are still two other methods of employing the quartz crystal, in both of which a valve oscillator is con-

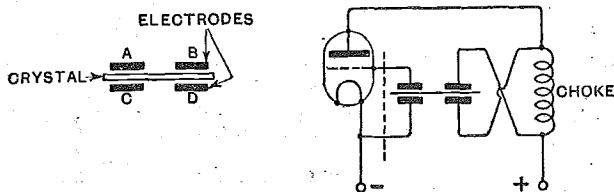

Fig. 16.—Controlling a valve oscillator with a special arrangement of crystals.

trolled solely by means of the crystal. The first, due to W. G. Cady, employs a special box for the crystal, using two pairs of electrodes (see Fig. 17), and is connected up as in Fig. 16.

Cady himself used ordinary valves and interposed two resistance-coupled amplifying valves in the position shown by the dotted line, but the authors, by employing low-capacity valves (Marconi V.24 and Q.X. types, etc.) and very small air gaps between crystal and electrodes, have been able to dispense with these.

Connected in the manner shown at the left-hand side of Fig. 17, the set oscillates on the second harmonic of the crystal. Placing on the primary a potential of the direction indicated, the left-hand half of the crystal elongates, absorbing some of the charge from the electrodes, and compresses the other half, which then, of course, gives out charges of the like sign to those absorbed at the other pair of electrodes. This takes place at twice the fundamental frequency of the crystal, when the charges given to the grid of the valve (from the secondary

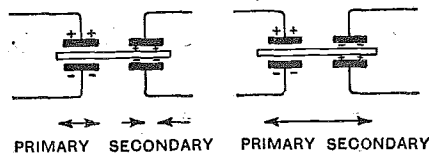

Fig. 17.—Arrangement of the crystals for the method of Fig. 16.

side) are sufficiently great to cause the valve to work as an oscillator.

If we reverse the connections to the choke coil, the oscillator operates (if the choke is large enough) at the fundamental frequency of the crystal. In this case the crystal expands as a whole and absorbs charges not only from the primary, but also the secondary electrodes, thereby leaving the latter charged in the opposite direction. (Taking a positive charge from a body is equi-

valent to giving it a negative one). Oscillators of this type are extremely constant to about 1 part in 50,000 under the most changeable circumstances. The choke coil

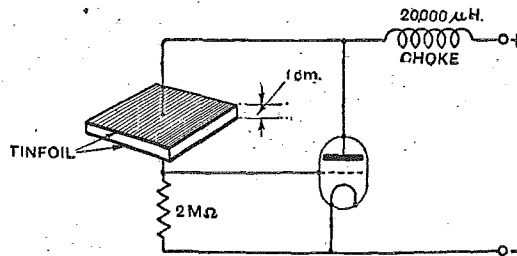

Fig. 18.—An alternative method of controlling a valve oscillator.

serves no other function than to permit the passage of the direct current to the anode.

G. W. Pierce has devised a second method of making the crystal oscillate (Fig. 18). He employs a large slab of quartz and sticks sheets of tin foil on opposite faces. In his method he employs the natural vibrations of the crystal in the direction of the thickness, and uses an ordinary valve.

Returning to the four electrode type of oscillator as being the simplest for the amateur to construct and operate, full details are given below of one having a frequency in its second harmonic mode of vibration of 220,000 cycles per second. The fundamental frequency is about half this. The crystal is 2.5 cms. long, 0.5 cm. wide, and 0.15 cm. thick (0.06in); the valve, a D.E.V.

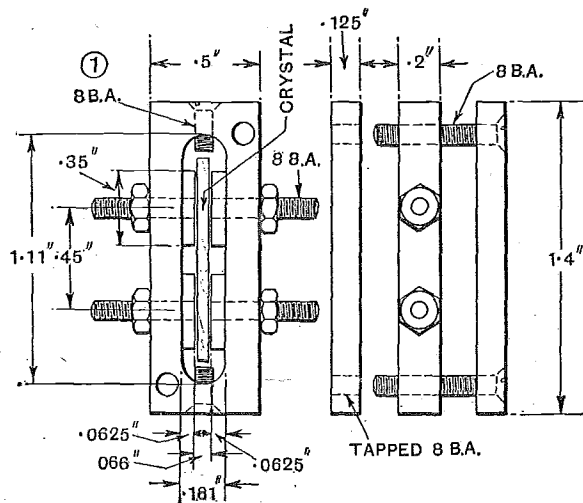

Fig. 19.—Details of the crystal box.

(Marconi); H.T. voltage, 36 volts; and the choke coil, 2,000 μH. Since a high resistance in the latter is not detrimental, any ordinary plug-in coil of the correct inductance may be used, such as the No. 200 Igranic. The filament of the valve normally running at 3 volts may be turned down to about 2 before the valve ceases to oscillate (it is usually necessary to tap the crystal box to start oscillations). The dimensions of the box are given in Fig. 19.

In constructing this, the first item is to obtain the sheet brass for the electrodes, as it is seldom exactly of the nominal thickness, and, of course, this determines the



**The Quartz Oscillator.—**

width of the slot. The electrodes are 0.35in. x 0.3in., with a centre hole tapped 8 BA, but it is better to make them about 0.23in. wide and rub down the projections flush with the ebonite after they are fitted. The slot is made by drilling at each end a hole whose diameter is equal to the width of the slot, and a chain of smaller holes down the centre. The intermediate parts are then filed out with a "rat-tail" file and finished off by a small "flat" or "ward" file. The sides of the slot

be described, one employing an ordinary quartz crystal resonator, the other an oscillator. In both cases the methods will be described with the refinements necessary for considerable accuracy, such as would be justified in calibrating, say, a heterodyne wavemeter, fitted into a screened case, and always used with the same phones, coupling coil, valve, H.T. voltage, and filament voltage. Alterations in these things make relatively large difference to the instrument calibration.

Case (1).—Suppose we have a crystal resonator of 1,000

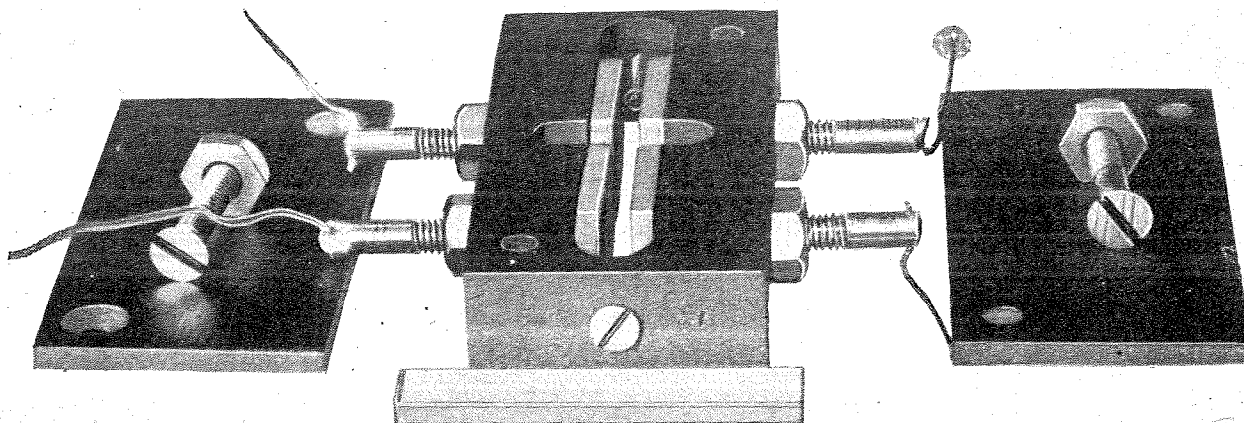

View of the crystal box with the covers removed.

when finished should be perfectly flat and parallel to each other, and the air-gap, when finished, accurate to about 0.002in. The top and bottom (fixed by two screws) are alike save that the holes in the former are tapped 8 BA and those in the bottom are countersunk.

The screws are adjusted in length by filing their ends or countersinking their heads until the end clearance is reduced to about 0.005in. as the amplitude of oscillations when the oscillator is in use is rather sensitive to endwise movement of the crystal. The connections are soldered to the projecting screwed rods, and that going

metres wavelength, and it is desired to calibrate a heterodyne wavemeter with range from 600 to 100 metres. For really accurate work it is very desirable to have a milliammeter in the anode circuit of the wavemeter, as the combination of ear and telephone is very insensitive for low notes, and if the wavemeter and another oscillator are placed very close together to increase the volume of the beat note in the phones, the two oscillators are liable to synchronise. That is, when the frequencies are very nearly equal, the oscillators sink their differences and run together as one.

First tune the oscillator and also the circuit  $L_1C_1$  (Fig. 20) to the frequency of the crystal. To get a sharp crevasse in the resonance curve of the latter,  $L_1$  should be about  $40 \mu H$ , and  $C_1$  about  $0.01 \mu F$ .  $L_3$  should be as large as  $L$  and coupled as tightly to it as possible. If, besides this, the oscillator valve has a large value of voltage magnification and about 100-200 volts H.T., we may fairly assume that all the harmonics up to about the tenth will be strongly marked. We now tune  $C$  until the valve voltmeter indicates that the oscillator is exactly at the natural frequency of the crystal, and then tune in the

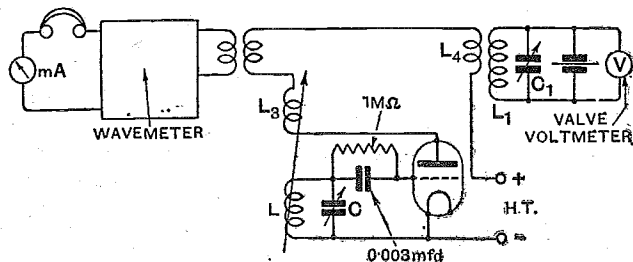

Fig. 20.—Arrangement of apparatus for calibrating a wavemeter.

to the grid should be kept as short as possible (not more than 10 cms.).

**The Calibration of a Wavemeter from a Single Crystal.**

This article would not be complete without a brief description of the method of calibrating a wavemeter with one of the quartz crystal standards, assuming the natural frequency of the latter to be known. Two methods will

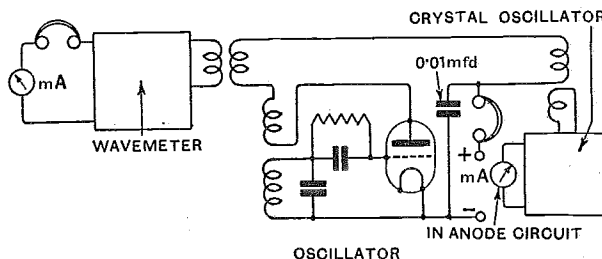

Fig. 21.—A second method of calibrating a wavemeter.

**The Quartz Oscillator.—**

wavemeter successively to the following harmonics of the oscillator.

2nd	500	metres	7th	128.57	metres
3rd	333.3	"	8th	125.0	"
4th	250	"	9th	111.1	"
5th	200	"	10th	100	"
6th	166.6	"			

It will be seen that the various points of calibration are very much closer at the higher frequencies. Therefore change  $L$  and  $L_3$  and tune to get the 3rd harmonic of the oscillator at the natural frequency of the crystal, the only difference in the remainder of the circuit being that  $L_4$  and  $L_1$  will require to be coupled much closer. We may now obtain the following frequencies:—

5th harmonic of oscillator	600	metres
6th	500	"
7th	428.57	"
8th	375	"
9th	333.3	"
10th	300	"

By tuning the oscillator so that other harmonics have the frequency of the crystal, we can obtain other intermediate frequencies.

Case (2).—Suppose we have to calibrate the same wavemeter as before and are provided with a crystal oscillator. The coupling coil of the crystal oscillator may be its choke coil. The method is exactly as before, except that the harmonics of the oscillator are set to the frequency of the crystal oscillator first by the beat note in the telephones, and more accurately by the beats indicated on the millimeter of the crystal oscillator.

A much wider range of frequencies is obtainable, as there are beats produced by the combinations of the harmonics of both oscillators (the crystal oscillator has generally the second and third fairly well marked).

As before, one set of frequencies is obtained by tuning the oscillator so that the third harmonic corresponds to 1,000 m. (the frequency of the crystal oscillator).

Then, by tuning the 5th harmonic of oscillator to the 2nd harmonic of crystal oscillator, *i.e.*, setting the oscillator to 2,500 metres wavelength, a second set is obtained:

6th harmonic of oscillator	416.6	metres
7th	357.13	"
8th	312.5	"
9th	277.7	"
10th	250	"

Similarly tuning the 10th harmonic of oscillator to the 3rd of crystal oscillator, the oscillator is set to 3333.3 metres wavelength, and its harmonics are

6th harmonic	555.5	metres
7th	474.74	"
8th	416.6	"
9th	370.37	"
10th	333.3	"

In similar groupings there are almost infinite variations; indeed, they are apt to be confusing unless one gets a few of the simpler and louder combinations first as a guide.

o o o o

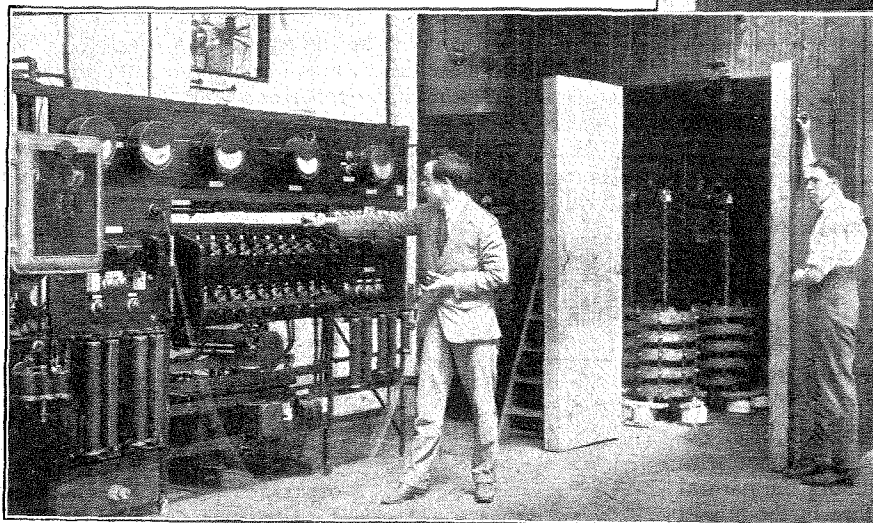
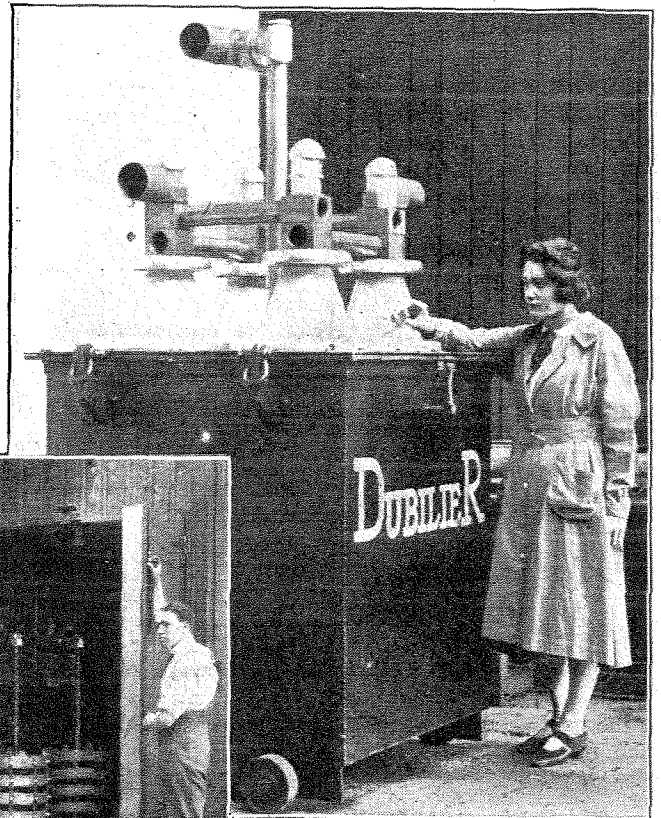
**WORLD'S LARGEST CONDENSER.**

The largest condenser yet constructed, built by the Dubilier Condenser Co. for the British Post Office. It is seen under test passing a current of 820 amperes at a moderately high radio frequency and at a potential of 32,000 volts. A low-frequency pressure test at 68,000 volts is also applied.

# FIRST RADIO EXHIBITION in HOLLAND



## Features of Interest at The Hague Show.

A WIRELESS Exhibition has just been held at Scheveningen, near The Hague, Holland. The exhibition is of special interest partly on account of the fact that it is the first public wireless exhibition to be held in Holland, in spite of the fact that, except for the early transmissions from the Eiffel Tower, the Dutch station PCGG, at The Hague, was the pioneer broadcasting station in Europe; in fact, it may be said that Holland set an example to the rest of Europe in the matter of broadcasting, although, unfortunately, that country has neglected to develop the service, and has allowed other European nations to profit by its early example.

The first regular European broadcast concerts were transmitted by the Dutch station at The Hague, PCGG, under the direction of Mr. Izerda, the first transmission being made in November, 1919. Those who were listeners in those early days will well remember these Sunday afternoon concerts from The Hague. Unfortunately, no machinery existed at that time to cover

the cost of this broadcasting enterprise, and public subscription was resorted to in order to maintain the station. It may be remembered that a fund was opened by the *Wireless World* to assist in financing the concerts, and that later the enterprise was subsidised by *The Daily Mail*. About that time, Writtle, 2MT, started up in England,

and later the British Broadcasting Company commenced operations.

The period of the Dutch exhibition was from May 29th to June 7th, and was held at the Kurhaus, at Scheveningen. There were in all thirty-six stands devoted to radio exhibits, and the principal display was undoubtedly that of the Philips Co., the Dutch valve manufacturers. A number of British firms showed apparatus, whilst there were representative products also of French, German, and American origin, and a comparatively small number of sets and parts manufactured in Holland. Up to the present, the wireless industry in Holland has not assumed important dimensions. This is, no doubt, because there is no national broadcasting



Fig. 1.—The motor car station with sausage aerial on the sea front.

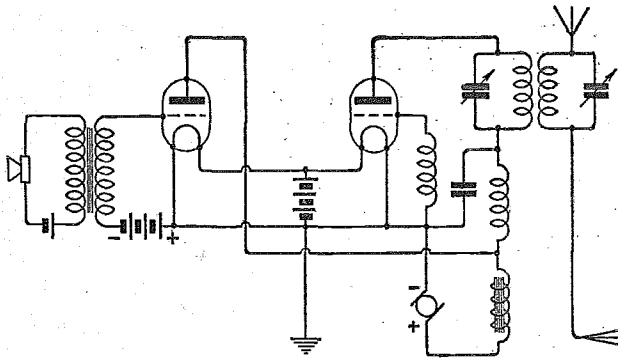

Fig. 2.—The circuit of the transmitters used in the motor car experiments.

yet in existence, and the only transmissions taking place in the country are those from the wireless station at Hilversum, which is financed only by public contributions.

The Western Electric Co. was responsible for arranging for the loud-speaker reproduction of broadcast concerts received and for relaying orchestral and band music from the Kurhaus to audiences outside the buildings, loud-speakers being arranged as shown in the photograph (Fig. 3).

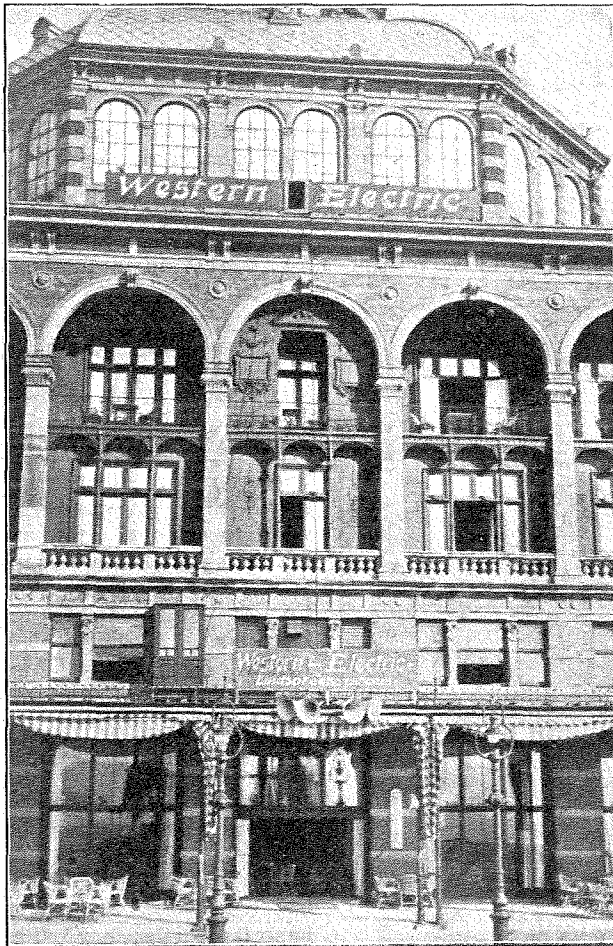

Fig. 3.—The front of the Kurhaus, showing the arrangement of the loud-speakers.

Of very special interest to the amateur, particularly to a visitor from abroad, was a display of amateur-built apparatus to which the space of one of the stands was devoted. The most striking piece of apparatus shown here was a receiver built on the lines of the Radiola Super-Heterodyne of America. This receiver was exhibited by Mr. H. J. J. Esmeyer, and although one was

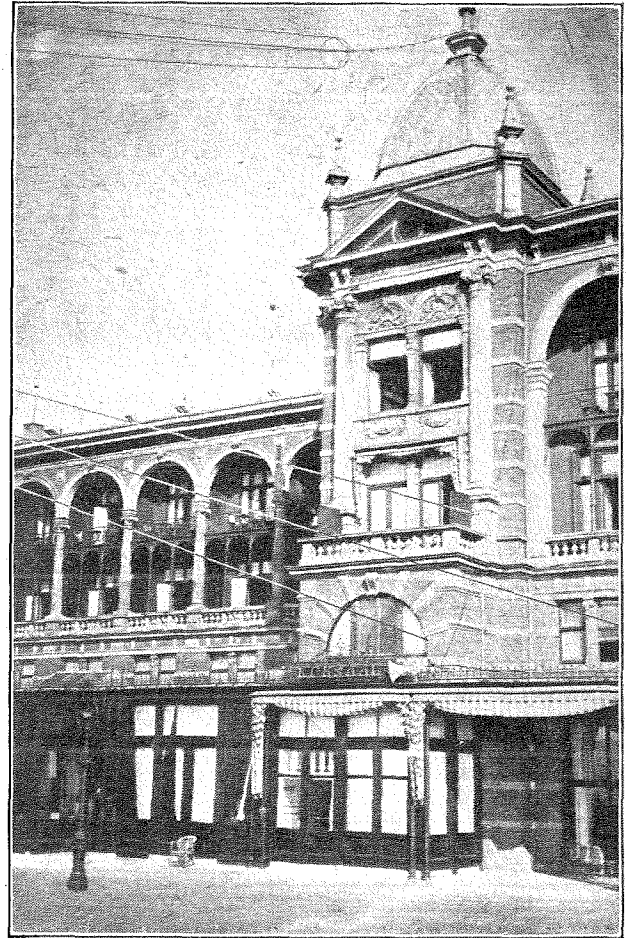

Fig. 4.—The sausage aerial and counterpoise wires of the fixed station.

not able to test the performance of the receiver, the design and workmanship were admirable.

By way of providing something out of the ordinary as an attraction for the exhibition, Mr. G. J. Eschauzier, a member of the Technical Committee of the exhibition, arranged for demonstrations of telephony communication on short waves. A motor car (Fig. 1) was equipped with a transmitter and receiver, and this car travelled round Schieveningen, maintaining communication with a fixed transmitter and receiver installed in the band-stand of the Kurhaus. For transmission a choke coupled circuit was employed, arranged as shown in Fig. 2. The wavelengths used were approximately 110 metres for the fixed stations and 70 metres for the motor car station. Fig. 4 shows the aerial and counterpoise slung between the band-stand and the Kurhaus.

# General Purpose Receiver.

Introducing Some  
Novel Features.

A Receiver Designed for  
Obtaining Maximum Efficiency  
with Three Valves.

By N. P. VINCER-MINTER.

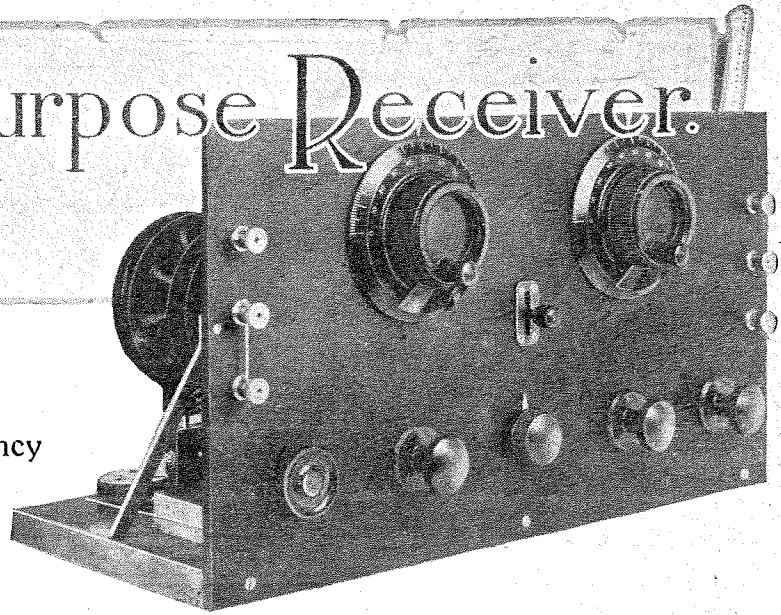

IN these days, when the desire for long-distance reception free from local interference is ever on the increase, multi-valve receivers of the supersonic, heterodyne and neutrodyne type are coming more and more into popular favour. As time goes on, and the number of stations in existence increases still further, the use of a highly sensitive and selective receiver embodying one or both of the aforementioned principles will become an absolute *sine qua non* to the man who desires to wander farther afield than his local station. Both of these types of receivers combine extreme sensitivity and selectivity, whilst at the same time, if properly designed and constructed, they are a delight to handle. The aforementioned "if" is, however, a very big one, and many people who have rushed into the purchase of expensive sets of parts of foreign manufacture find now that they have much food for thought not of a very pleasant character.

A source of expense which is greatly overlooked by many of those who are at present swelling the imports of this country is the supply of H.T., which in the case of one greatly "boomed" six-valve receiver rises to no fewer than thirty or forty milliamperes, a rate which would make even a "super" H.T. battery wilt if continued over a prolonged period. The second disadvantage of receivers of this type lies in the fact that it is quite impossible for the average man, at the moment of writing, to purchase a set of commercially made parts and a blueprint with any certain hope that he will attain the success he desires.

### Combining Efficiency and Economy.

To the man whose desire is to build an economical set capable of picking up any of the main B.B.C. and Continental stations at good telephone strength, and one or two of the nearer ones on the loud-speaker, there is no better circuit which can be recommended to him than a straight three-valve circuit embodying one high-frequency and one low-frequency valve with magnetic reaction carried from the plate circuit of the detector valve to the aerial circuit.

Of course, there are many people already possessing sets of this description who may read the foregoing statement with a somewhat cynical smile, since they probably do not get anything like the results mentioned, which they certainly should get. However, when one has had some experience in inspecting a large number of home-constructed sets it is a source of great wonderment that anything is received at all on some of them.

When building a valve set it is necessary to observe closely four hard and fast rules, which are: (1) use good quality components only; (2) preferably avoid switches in high-frequency circuits, not excluding those of the so-called anti-capacity type; (3) avoid the use of loosely hanging insulated wires for connecting up the components of the receiver; (4) carefully dispose all components and wiring so that all wiring preceding the detector valve is as short and widely separated as possible, particular attention being

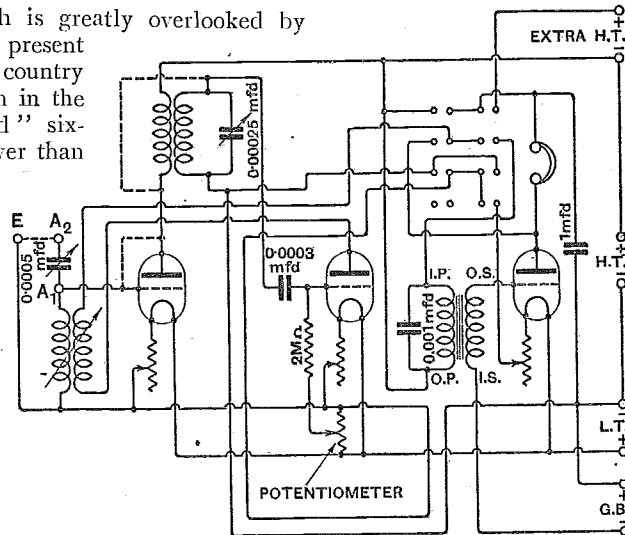

Fig. 1.—Theoretical connections of set.

**General Purpose Receiver.—**

paid in this respect to the wiring immediately associated with valves which are actually concerned with the reception of signals.

**Importance of Avoiding Switching.**

To sum up on these points, the writer would like to emphasise the necessity for avoiding any type of switching in H.F. circuits at all costs, since this appears to be the principal pit into which amateurs are prone to fall. Do *not* attempt the performance of any switching gymnastics, the purpose of which is to enable the receiver to be converted from a straight three-valve circuit to a neutrodyne or a supersonic "reflexodyne" by means of an imposing array of switches. When purchasing a motor cycle one would not demand a machine which was capable of being converted from a two-stroke to a four-stroke by means of a complicated set of levers, and yet the ideas of many people with regard to wireless receiving sets are in reality no less absurd—far less so, in fact, than in many cases which have come within the writer's venue. As the chief engineer of the B.B.C. is wont to say relative to another matter: "Please don't do it."

An attempt has been made by the writer to design a straight and simply operated three-valve set which really is capable of distant reception on the broadcasting band of wavelengths and above, whilst special attention has been paid in the receiver to the question of selectivity, a system of H.F. coupling being used in the instrument for this purpose, which, while it is at least as old as the ubiquitous tuned anode, has been greatly neglected by the amateur.

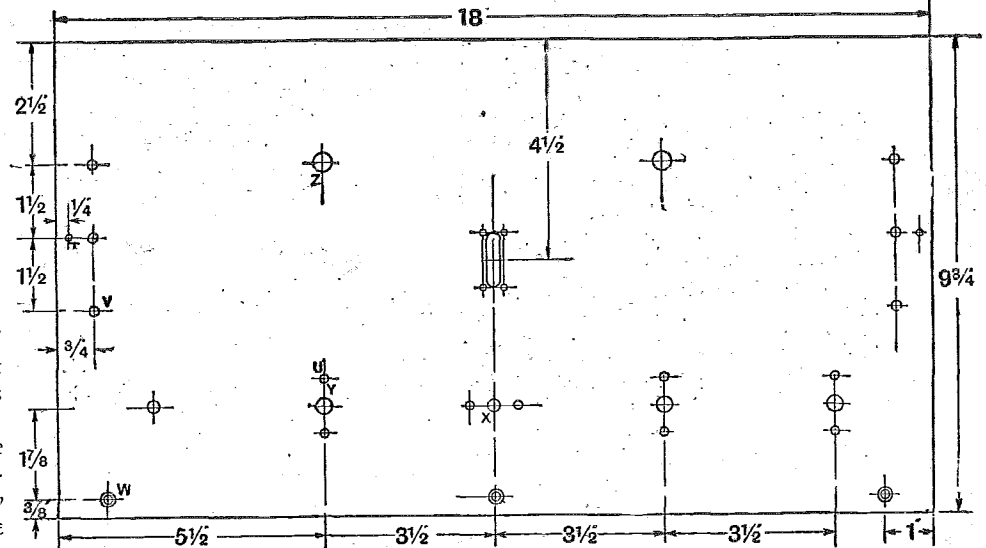

Fig. 2.—Dimensional drawings of front panel. Drilling sizes: T, 1/8in. clearance for 6 BA; U, 5/32in. clearance for 4 BA; V, 3/16in. clearance for 2 BA; W, 3/16in. and countersunk for No. 4 wood screw; X, 5/16in.; Y, 3/8in.; Z, 7/16in.

The writer experimented considerably with commercially made coils of the type shown in the photographs, and obtained excellent results. It is essential that the two coils be very closely and permanently coupled, otherwise serious loss of signal strength will result. The great advantage of this particular type of coil in this respect is that the size is uniform for any value of inductance. Thus, the two single coil holders can be permanently mounted side by side on the baseboard with the assurance that on any wavelength the coil casings will be in actual contact. With many types of coils it is not possible to do this. In addition to this consideration, the writer has no fault to find with the H.F. efficiency displayed by these components.

It cannot be too strongly emphasised that for best results from the point of view of easy distance getting, the reaction coil should be kept as small as is practically possible.

**Choosing the Components.**

Before proceeding to the actual constructional details of the receiver, it would be well to say a few words concerning the choice of components. Needless to say, these should all be of the highest possible quality. Particular attention should be paid to the choice of variable condensers. It is advised by the writer that these should be of the low loss type. Since British-made low loss condensers may now be obtained at a price not exceeding that of an ordinary variable condenser, this point need present no difficulty. With regard to the actual condensers used, it was found that they

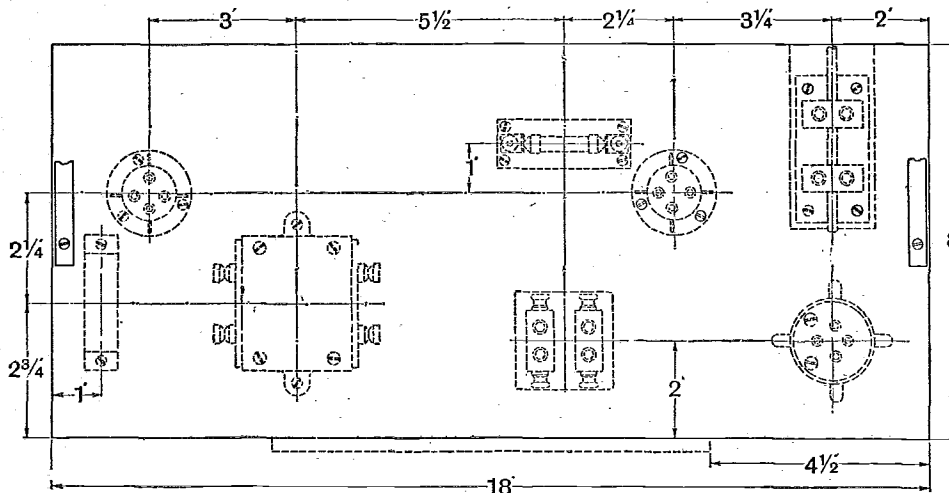

Fig. 3.—Dimensional layout of components on baseboard.

**General Purpose Receiver.—**

were fully equal in efficiency to American condensers selling at a much higher price. It is strongly urged that, if the reader wishes to construct a receiver in which efficiency is the primary consideration, a variable condenser of 0.00025 mfd. be used to tune the secondary of the H.F. transformer.

It is strongly recommended, also, that the plain type of condenser without the vernier plate be obtained, fine tuning being effected by the use of slow-motion dials, enabling a fine movement to be imparted to the main bank of plates when necessary. Any make of L.F. transformer will, of course, function in this circuit.

The writer was agreeably surprised at the excellent tone produced by the actual instrument used in this set, the lower musical frequencies being reproduced in a manner which is not usually associated with transformer coupling of the ordinary type. The type of switch for controlling the L.F. stage should be noted, since it is necessary to employ a type having a central zero position, so that when it is in the central position all batteries are disconnected.

**Necessity for Carefully Spacing Components.**

With regard to the actual constructional work, this should present no great difficulty. Having first obtained the necessary components, the panel and the small ebonite strip should be carefully squared up and rubbed down in the usual manner. The next operation is to carefully mark and drill the panel, and then all components can be immediately mounted upon panel and baseboard. The disposition of these is easily followed by carefully studying Figs. 2 and 3. It should be noted that it is necessary to mount the coil holder on a wood block one inch in height, in order to bring the shaft of the coil holder in line with the hole drilled in the panel. Wiring should be very carefully carried out with No. 16 bare tinned copper wire, and it should be rigid and well spaced, the actual disposition of wiring indicated in the photographs being followed as closely as possible. It is advisable to dispose of as much of the wiring as is possible before attaching the panel to the baseboard. Special care should

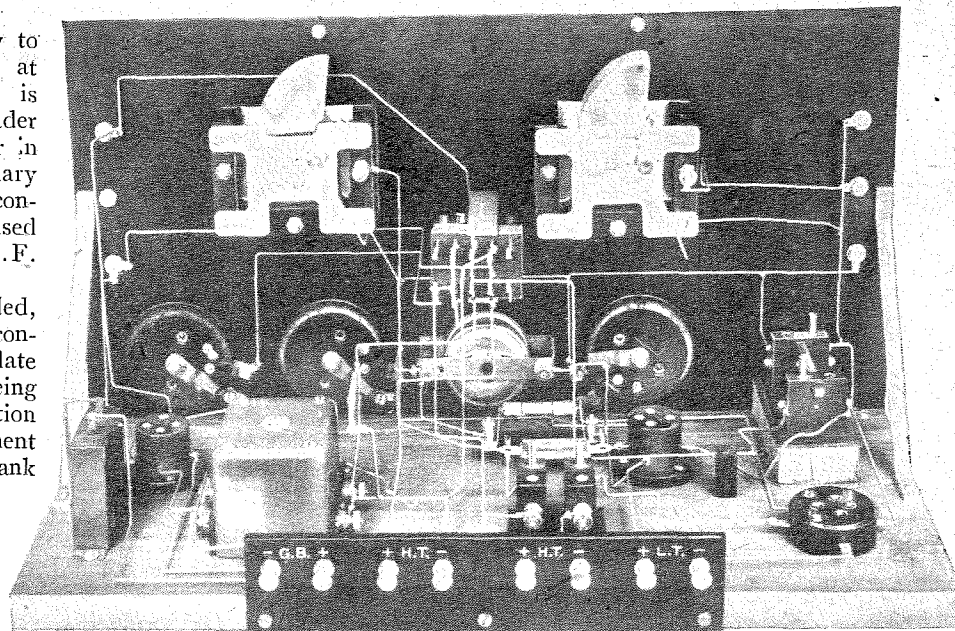

The general disposition of the wiring is plainly visible. Note the method of mounting the coil holder.

be devoted to the wiring of the switch, which is somewhat complicated. It will be noticed that two aerial terminals are used and arrangements made for obtaining series or parallel tuning without resort to switching. For parallel tuning the aerial is connected to the top terminal (A<sub>2</sub>), the lower two being joined by a piece of wire. When series tuning is desired it is only necessary to remove the piece of wire and connect the aerial to the second terminal down (A<sub>1</sub>). The earth connection is, of course, always made to the third terminal down.

Before commencing the actual testing of the receiver, it will be well to first make up the "gadget" illustrated in Fig. 7. Fig. 7 is practically self-explanatory, the component merely consisting of two pairs of fixed coil mountings, a small ebonite platform, and four valve sockets, its purpose being to permit of the use of an ordinary plug-in transformer when desired in place of the two coils previously described. It is *strongly* advised that in the initial experiments with this receiver such a component be used, and, indeed, many readers may prefer to use it permanently. There is no need to alter the connections of the variable condenser, since the effect of tuning the secondary will not be different from that observed when tuning the primary, as is more conventional. After having attained good results with this, the next step is to try basket or plug-in coils of *equal size*, and later the size of the primary coil can be reduced in order to increase selectivity. Do not forget that it is of vital importance that the coils be closely coupled. It must not be forgotten, also, that it will be necessary to experiment with the connections of the reaction coil in the usual manner.

**Testing and Operating the Receiver.**

This receiver was tested on a normal aerial and earth system, not especially noted for its efficiency, at a distance

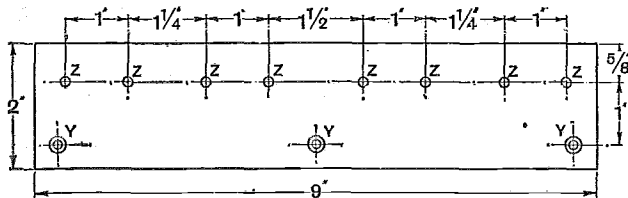

Fig. 4.—Dimensional drawing of terminal strip. Drilling sizes: Y, 1/8in., and countersunk for No. 4 wood screw; Z, 5/32in.

**General Purpose Receiver.—**

of approximately 50 miles N.E. of zLO. Using an "A" coil for aerial tuning, an "a" for reaction, and a Sullivan No. 1 H.F. transformer, zLO was received on the loud-speaker with excellent quality, and with quite sufficient strength for a fair-sized living room. Using the same coils, Bournemouth was received at excellent telephone strength, and later in the evening Madrid came in with very pleasing tone and volume without any "reaction forcing." Upon substituting two Gambrell "C" coils for the plug-in transformer, no difference was noticed in volume, but tuning on the 0.00025 condenser was noticeably sharper. Upon substituting a "B" coil in the primary there was no appreciable decrease in volume, but tuning became very much sharper, and the vernier dial was much appreciated. The use of an "A" coil for primary made the tuning excessively sharp, but very

considerably reduced signal strength. The use of such a coil, however, is of great use where reception of a distant station at not very great strength is desired when a comparatively near-by station is working. When larger coils were substituted it was found that Birmingham came in very well, whilst several other stations were received less satisfactorily, and with a great deal of "reaction forcing." Ordinary general purpose valves were used throughout, the potentiometer on the detector valve being kept over to the positive side, and the terminals for extra H.T. and for G.B. being "shorted." The writer then removed the general purpose valve from the H.F. valve socket and substituted a low-capacity valve of the V24 type, held in an adaptor. Immediately upon doing this a great increase in range and ease of tuning was noticeable, stations which had hitherto only been receivable with tight reaction coupling coming in very easily

with excellent volume and quality with a very small degree of reaction coupling. The set was also more stable when using this valve for H.F. The foregoing results with this type of valve were what one might be led to expect from laboratory measurements, since it is found on actual test that the greater proportion of the stray capacity associated with an ordinary valve contained in its holder exists not in the valve holder, but in the "pinch" of the valve. Many people might be led to believe that the use of a V24 valve in an adaptor and ordinary valve holder is futile by reason of the ordinary valve holder nullifying the benefits derived from the low-capacity valve, but in actual practice this is not so, and measurement shows that the capacity existent when a valve of this type is used in an ordinary holder is about four times less than when an ordinary type valve is used, whilst the mounting of the low-capacity valve in its special clips gives us very little added advantage over its use in an adaptor. The use of such a valve is therefore strongly recommended by the writer, not only in this set, but in any type of set employing an H.F. stage, and more especially in those sets employing two stages of H.F. without neutrodyning, and hitherto regarded as

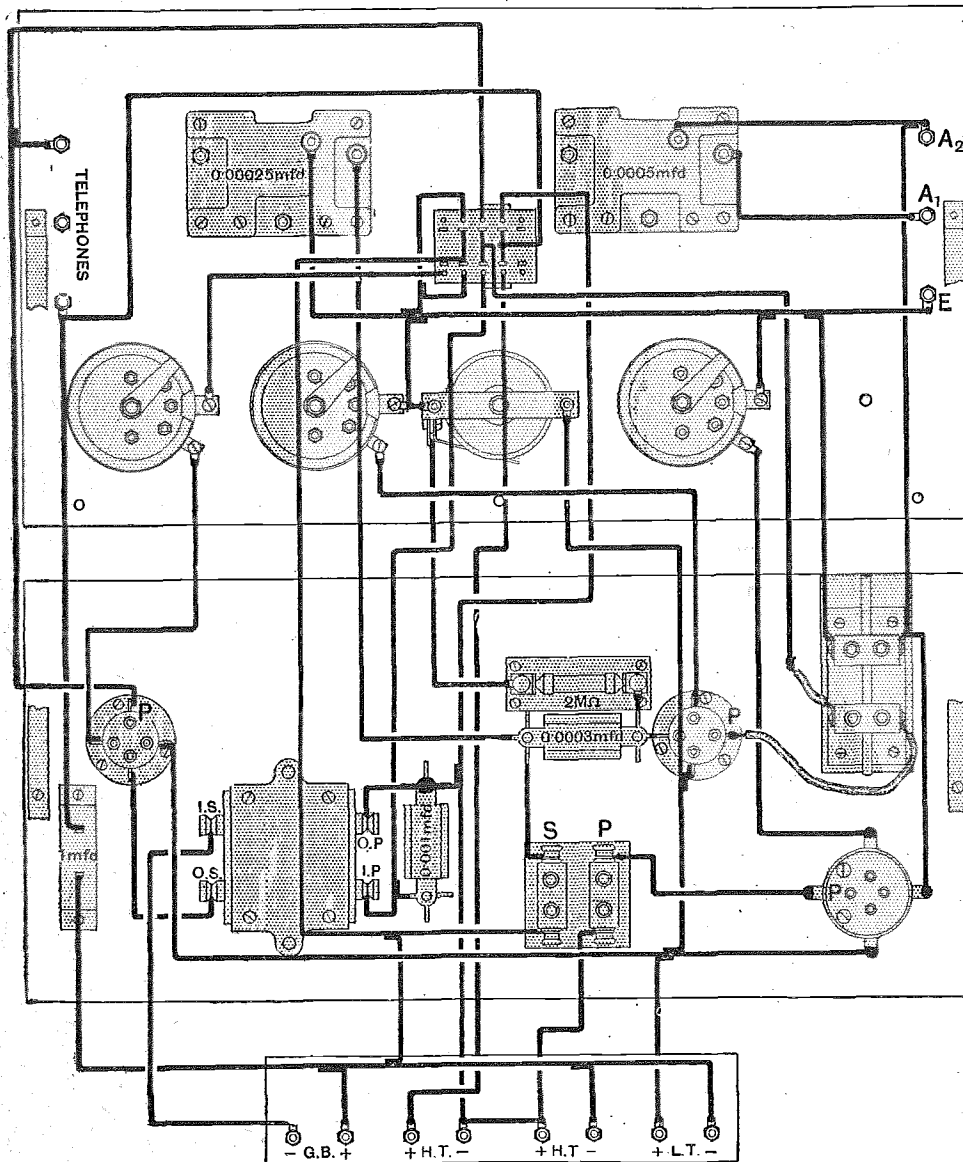

Fig. 5.—It will be seen from this practical wiring diagram that all H.F. wiring is as widely spaced as possible.



**General Purpose Receiver.—**

"untameable." Its use will make all the difference between "easy" distant reception and the reverse. At the same time the ordinary precautions with regard to the wiring must not be neglected, and the use of an anti-capacity type of valve holder in the H.F. stage is urged, whatever type of valve is used. The writer actually tried this type of valve for H.F. in a tuned anode receiver of very inefficient type which is normally very unstable, and a great improvement was at once noted, both in regard to range and ease of tuning.

**Eliminating Interference.**

In the area in which the set was tested, Morse interference from ships was very prevalent, and although the system of H.F. coupling employed did much to mitigate this evil, it was quite impossible to entirely eliminate it, nor would this be possible even with an ultra selective receiver of the superheterodyne type.

The receiver was later tested on an aerial situated ten miles from the London broadcasting station, and no trouble whatever was experienced in completely eliminating the local transmission and receiving several other British and Continental stations with excellent strength and quality. In the course of these later tests the reaction coil was temporarily short-circuited, and a valve with high amplification factor (actually the Marconi DE5B and DE3B) was inserted into the detector valve socket and excellent loud-speaker results obtained, the signals being considerably louder than when an ordinary type of valve was used. It is, however, noticeable that when this type of valve is used, it functions far better as a detector when the bottom end of the grid leak is connected to the negative end of the L.T. battery rather than to the positive side, and in this respect the potentiometer will be extremely useful, although this was not the main purpose for which the potentiometer was included. It is not recommended, however, that this valve be employed for long-distance reception, since reaction control will be found very erratic. When used as a detector valve the DE5B does not, of course, require any extra value of H.T., as is the case when used as an L.F. amplifier. With regard to the DE3B, which functions at 3 volts 0.06 amps, the writer used a temporary fixed filament resistance of 45 ohms in series with the filament of this valve.

To the reader who is seeking a better valve than the ordinary "R" type for a rectifier, the DE5 can confidently be recommended, since not only will it be found more sensitive for long-distance reception, but the quality

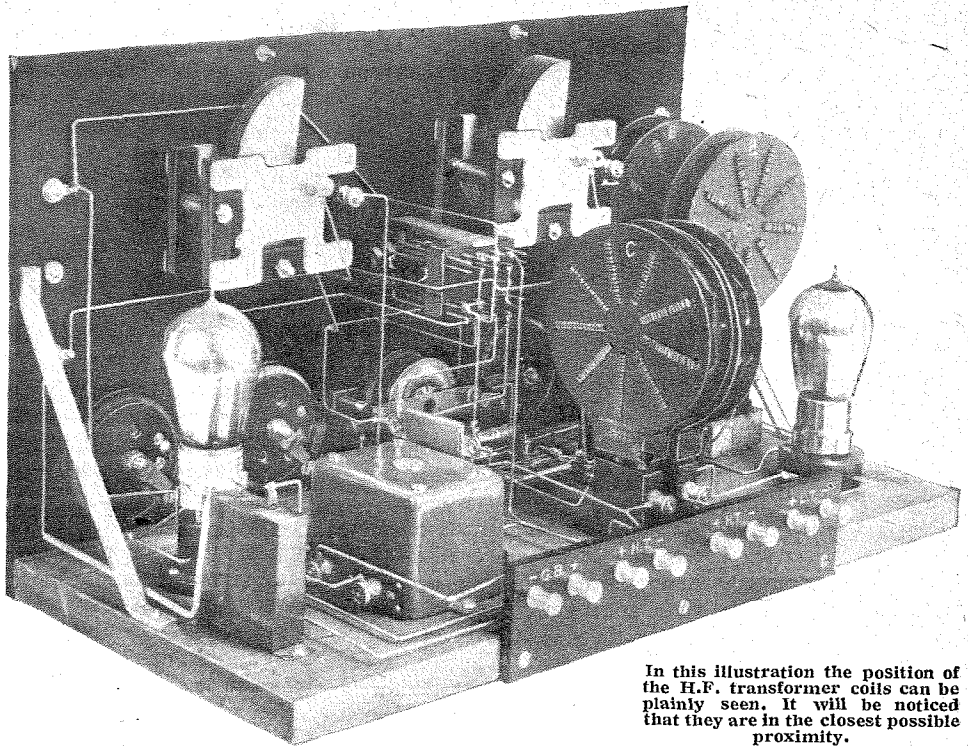

In this illustration the position of the H.F. transformer coils can be plainly seen. It will be noticed that they are in the closest possible proximity.

of loud-speaker reproduction will be improved, since the lower impedance of this valve is better suited to the impedance of the transformer primary which follows it. For best quality loud-speaker results it is recommended that a power valve of the DE5A type be used in the L.F. stage with the correct value of extra H.T. and grid bias.

**Method of Cutting out the H.F. Valve.**

For the local station, the use of the H.F. valve is rather a waste of filament current, and the absence of a switch in this portion of the circuit may be deplored by many. This point was, however, not forgotten by the writer, and a glance at the theoretical diagram in Fig. 1 will at once render the *modus operandi* for eliminating this valve apparent. Assuming that we remove our H.F. valve and the H.F. transformer coils from their respective sockets and make temporary flexible connections in accordance with the dotted lines on the theoretical diagram, it will be seen at once that we have a very efficient regenerative detector valve circuit without H.F., whilst at the same time no efficiency has been lost, such as would have been the case had a switch been incorporated in this portion of the receiver. The reason for not connecting the grid leak across the grid condenser will now become apparent. In order to avoid untidy flexible connections, it is recommended that the two small "gadgets" shown in Fig. 8 be made up. The illustrations are quite self-explanatory, the "gadgets" shown consisting merely of bridging pieces designed for uniting the grid and plate sockets of the detector valve, and the two "pins" of the two single-coil holders of the H.F. transformer respectively, in accordance with the theoretical diagram in Fig. 1. Actually the writer tuned in several stations at quite good strength without the H.F. valve, whilst

**General Purpose Receiver.—**

by short-circuiting the reaction coil and using a DE5B valve in the manner already described the local station came in at excellent loud-speaker strength.

**Reception Below 100 Metres.**

It was intended by the writer when originally designing this receiver that the set should be capable of receiving the KDKA 68-metre transmissions with reasonable efficiency under normal conditions, and it was actu-

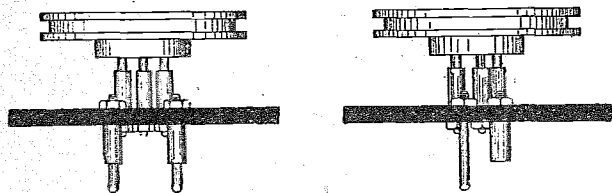

Fig. 6.—By constructing this small "gadget" an ordinary H.F. transformer may be used.

ally for this purpose that the potentiometer was included. The set was first tried with the H.F. valve eliminated in the manner already described, and using ordinary valves. After a little time spent in "searching," a carrier wave was picked up in the neighbourhood of 68 metres, and finally resolved into speech. The words of the announcer were distinguishable, and the station was definitely identified, but reception was by no means strong. The detector valve was then removed from its socket, and a "QX" type valve held in an adaptor was inserted, the  $2\text{ M}\Omega$  grid leak being substituted by one of  $5\text{ M}\Omega$  value, and the potentiometer then came into its own. Within a few moments KDKA was picked up without any difficulty, and with a volume that was in marked contrast to the results obtained with the ordinary type of valve. Gambrell  $a_2$  coils were used throughout for aerial tuning and reaction, and proved excellent for this purpose.

Later, the set was tried for reception of American broadcasting stations on the ordinary wavelengths, using the H.F. stage and with ordinary valves throughout. Fair results were obtained after midnight on WGY. The V24 was then tried in the H.F. stage, and results were improved beyond all recognition. Very little improvement was noticed, however, by using the "QX" valve as a detector on this wavelength.

Needless to state, during the tests of this receiver Chelmsford, Radio Paris, and other long-wave stations were received at excellent strength. Many readers living

in close proximity to a main broadcasting station will naturally enquire whether the receiver will enable the local station to be eliminated and others received. The answer is, unfortunately, in the negative, although the writer in subsequent tests found that it was possible to completely eliminate the local station at a considerably closer range than was possible with the ordinary type of tuned anode receiver, whilst the same instability was not present as is the case when using a loosely coupled aerial circuit. Let it be said definitely that the only solution for people living close to a main station is the supersonic heterodyne receiver.

The question may be raised by many regarding the non-inclusion of a second stage of L.F., but, in the writer's experience, this is undesirable in a general-purpose receiver, since he has found that one stage of transformer-coupled L.F. amplification will give as much loud-speaker volume as is obtainable without distortion under ordinary conditions, unless the use of special power valves with very high H.T. values is resorted to. It is no exaggeration to state that the cause of 90 per cent. of the repugnance evinced for the loud-speaker by musically inclined people lies at the door of the conventional two L.F. set, where either general-purpose valves or small-power valves with an insufficient value of high-tension voltage and grid bias are used, and if exceptional volume is desired the writer always recommends the construction of a specially designed power amplifier with its own separate H.T.

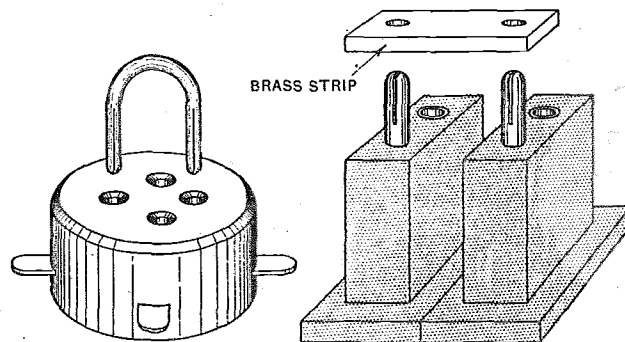

Fig. 7.—Simple method of eliminating the H.F. valve without switching.

supply and using valves capable of dealing with large power without overloading. Provided that this is done, a two-stage power amplifier can be used after this receiver without causing distortion or low-frequency "howling."

**LIST OF COMPONENTS.**

- 1 Ebonite panel, 18in.  $\times$  9 $\frac{1}{2}$ in.  $\times$   $\frac{1}{4}$ in.
- 1 Ebonite strip, 9in.  $\times$  2in.  $\times$   $\frac{1}{4}$ in.
- 1 Baseboard, 18in.  $\times$  8in.  $\times$  1in.
- 2 Brass brackets (Young Bros., Old Street, E.C.).
- 1 Vernier two-way coil holder (Smith Bros., Charing Cross Road, W.C.).
- 1 0-0005 mfd. low loss square law condenser (Ormonde).
- 1 0-00025 mfd. low loss square law condenser (Ormonde).
- 4 Rheostats (Burndept).
- 1 300 ohm Potentiometer (Igranic).
- 1 First stage L.F. transformer (Gambrell Bros., 76, Victoria Street, S.W.1).
- 1 Board mounting anti-capacity valve holder (H.T.C. Electrical Co., Boundaries Road, Balham, London, S.W.).

- 2 Ordinary valve holders for board mounting (Burndept).
- 1 0-0003 mfd. fixed condenser (Therla Electrical Research Laboratories, London).
- 1 0-001 mfd. fixed condenser (Therla Electrical Research Laboratories, London).
- 1 1 mfd. fixed condenser (T.C.C.)
- 1 2 M $\Omega$  grid leak (Dubilier).
- 1 Grid leak holder (Wainwright Manufacturing Co., Ltd., 531, Forest Road, Walthamstow, E.17).
- 2 Single coil holders (Fleet Radio Stores, 143 Fleet Street, E.C.).
- 6 Large nickel terminals (Horne Bros., 32, Gracechurch Street, E.C.).
- 8 Brass terminals.

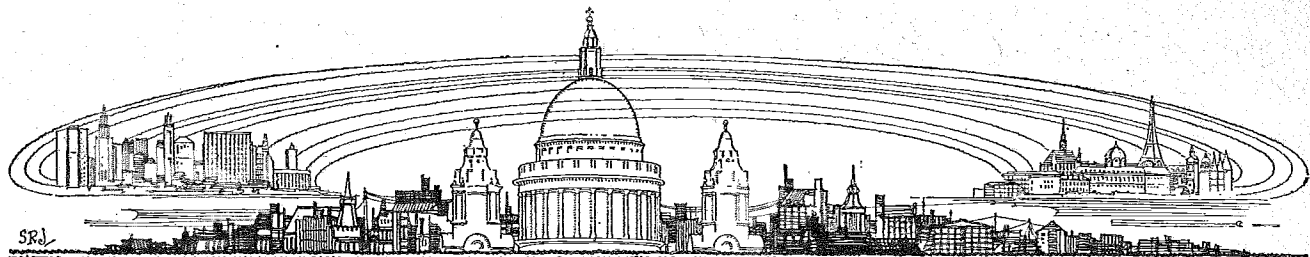

# CURRENT TOPICS

## Events of the Week in Brief Review.

### NEXT YEAR'S ESPERANTO CONGRESS.

The Eighteenth Universal Esperanto Congress is to be held in Edinburgh at the beginning of August, 1926.

o o o o

### WEATHER FORECASTS FOR FARMERS.

The Minister of Agriculture states that it is hoped to broadcast a special weather bulletin for farmers about 10 a.m. each day, commencing as early as possible in July.

o o o o

### NRRL STILL ACTIVE.

NRRL, the experimental short-wave station attached to the U.S. Pacific Fleet, and operated by Mr. F. H. Schnell, is still active. On June 4th, at 2.15 a.m., Mr. F. J. Taylor, of Birmingham, picked up Mr. Schnell's signals to NKF on 40 metres. Atmospherics were very troublesome.

o o o o

### FINLAND AND CHINA.

Lieut. E. V. R. Lind (Finnish 2NN), of Helsinki, reports that he is able to establish communication every evening at 9 p.m. (G.M.T.) with HVA, Hanoi, China. Working first took place on 50 metres, but Lieut. Lind states that better results are obtained on 70 metres.

o o o o

### RECEPTION ON AN OSCILLATING CRYSTAL.

A list of calls, heard while experimenting with an oscillating crystal receiver, has been forwarded by Mr. J. Hum, of Muswell Hill, London. The stations are: 2AVB, 2JB, 2MK, 2JU, 5OX, 200, 5CT, 5HT, 6KJ, 6DX, and 5VQ. The most distant morse station (spark) picked up was GKR (Wick, N.B.).

o o o o

### WIRELESS IN GREECE.

The Greek National Assembly has rejected the proposed agreement with the Marconi Company concerning the establishment of wireless stations in Greece.

o o o o

### NAVAL WIRELESS REPORTS.

The Admiralty have decided that in future H.M. ships on passage are not to make daily wireless telegraph reports of their noon positions, unless specially ordered to do so. This special order, if considered necessary, will either be included in their sailing directions or communicated to them by wireless telegraph.

### GERMAN BROADCASTING ASSOCIATION.

Germany now possesses an Imperial Radio Association, which embraces the broadcasting societies in Hamburg, Leipzig, Frankfurt, Breslau, and Königsburg.

The objects of the new body are stated to be common control and technical co-ordination.

o o o o

### WIRELESS ON FRENCH LIGHTHOUSES.

According to a Paris message it is proposed to install wireless on lighthouses which are to be constructed at different points along the French coast. Wireless would be of exceptional use in the foggy weather which frequently assails the French coast.

o o o o

### KILLED WHILE ERECTING AERIAL.

A verdict of accidental death was returned at a Hammersmith inquest on John Stephen Old, aged 17, who fell through a skylight while assisting to erect a wireless aerial.

### ICHABOD.

The famous Marconi station at Clifden, Ireland, is to be dismantled. Before the war this station was one of the principal transmitters of the world, maintaining regular commercial communication with America.

o o o o

### INTERNATIONAL WIRELESS EXPOSITION.

An International Exposition of Wireless Telegraphy and Telephony is to be held in Geneva from September 23rd to October 4th. The Secretarial offices of the Exposition are at 6, Boulevard du Théâtre, Geneva.

o o o o

### TELEPHONY WITH AMERICA.

A pleasant discovery has been made by Mr. E. T. Manley (G2FU), of Wimbledon Park, London, who has received notification from an American amateur that his telephony was picked up at good strength on March 14th last. Mr. Manley had been carrying out Morse tests with U3BWT of Washington, D.C., on that date, and before closing down attempted telephony. Owing to atmospheric and general disturbance, however, no reply could be distinguished. U3BWT now writes: "Your fone was surely great; could understand everything you said O.K." Strangely enough, several British amateurs had reported 2FU's modulation as poor.

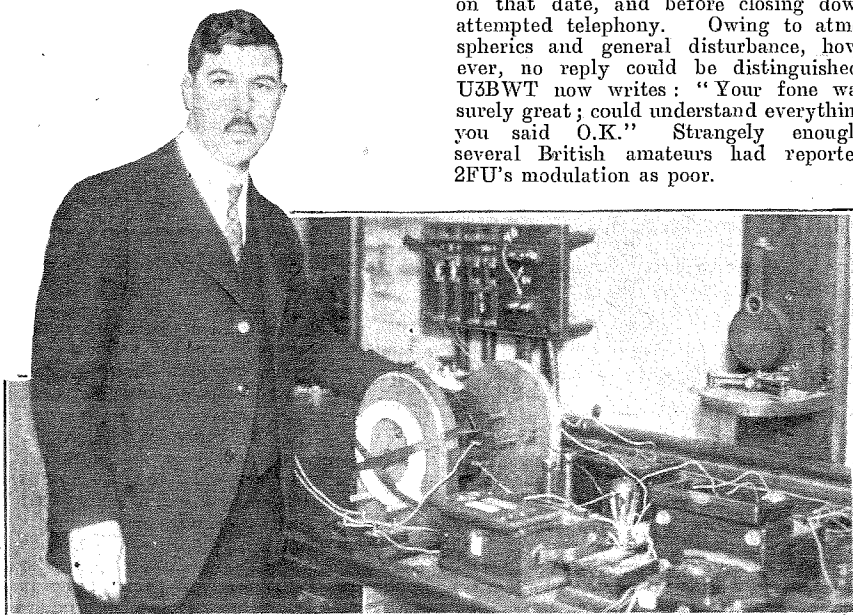

THE INVENTOR OF THE NEUTRODYNE. A recent portrait of Professor L. A. Hazeltine, taken in his laboratory, at the Stevens Institute of Technology, Hoboken, N.J. Professor Hazeltine is head of the Department of Electrical Engineering in the Institute.

**WIRELESS REGULATIONS FOR SHIPS.**

The Board of Trade, pending the passing of the Merchant Shipping (Equivalent Provisions) Bill, has agreed with the French Government a provisional arrangement for the reciprocal recognition of Wireless Telegraphy Regulations.

Under this arrangement British and French ships when visiting ports of the other country are obliged only to comply with the wireless requirements of the country to which they belong.

**MARINE WIRELESS RECORD.**

What is claimed to be a world's record for marine wireless telegraphy has been established by Amalgamated Wireless (Australasia), Ltd., by maintaining regular daily communication in Sydney with R.M.S. *Niagara* throughout the vessel's voyage to Vancouver.

The apparatus used by the company employs "beam" principles, but dispenses with reflectors.

**STUNT BROADCASTING IN AMERICA.**

The broadcasting "stunt" is being exploited to the fullest possible extent in America. The latest novelty for the delectation of listeners was the recent broadcast description, from an aeroplane, of the race between Gar Wood's speed boats and the Twentieth Century Limited from Albany to New York.

The descriptive speech was given by Captain H. M. McClelland on a D.H. aeroplane, using a General Electric 50-watt telephony transmitter working on 350 metres. During the first 40 miles the speech was picked up at Albany, then Poughkeepsie "took over," and finally the reception was carried out at Van Cortlandt Park. Each of these receiving stations was connected by wire to WGY and WJZ.

At times, when the aeroplane transmission became indistinct, the comments were repeated by announcers on the ground.

**A CORRECTION.**

In recent advertisements of the Dubilier Condenser Co., Ltd., the prices of the Vanicon variable condenser have been incorrectly quoted. The correct prices are: 0.0005 mfd. (with vernier), 22s. 6d.; 0.001 mfd. (with vernier), 27s. 6d.

**AUSTRALIAN OFFICIAL WIRELESS SERVICE.**

An official wireless news service to ships at sea has been inaugurated in Australia, transmission being made from Sydney, Darwin and Perth. Many mail-boat passengers have recently complained that the bulk of news messages are received from Germany.

**WGY ON SHORT WAVELENGTH.**

A reader reports the recent reception of an unknown station re-transmitting the programmes from WGY on a wavelength of 40 metres. Have any other readers picked up these transmissions?

**ILLICIT USE OF CALL SIGN.**

The call sign 2FQ is being used illicitly by another transmitter, according to its owner, Mr. W. W. Burnham, of Chislehurst, Kent. Information leading to the detection of the culprit is welcomed.

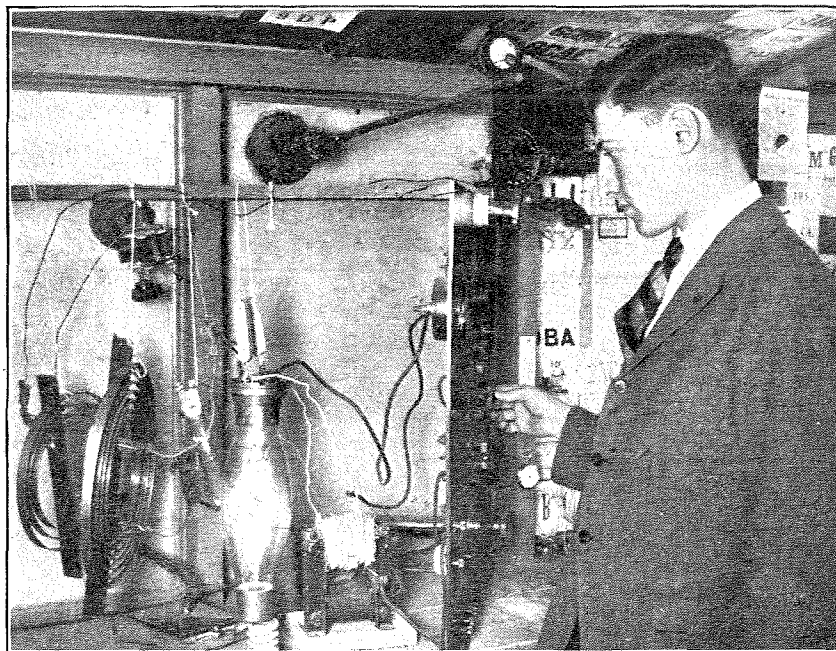

**A SUSPENDED TRANSMITTER.** In justice to our American friends we would point out that the transmitter illustrated above, owned by Mr. E. M. Glaser (U 2BRB), does not represent typical American short-wave practice. It will be seen that Mr. Glaser suspends practically all his apparatus on lengths of string.

**AIRCRAFT WIRELESS FOR ARCTIC EXPEDITION.**

Successful tests have been carried out with the Zenith transmitting apparatus installed on the three aeroplanes which are to accompany the McMillan Arctic Expedition. When the first experiments were made at the Great Lakes Naval Training Station, Illinois, an improvised aerial was used only two feet above the pilot's head. Amateurs in all directions reported good reception, and the apparatus is considered suitable for all the work that may be required of it.

An important feature of the sets, which operate on 37 metres, is the fact that they operate on dry cells only. This will permit aeroplanes to communicate while on the ground with the engine stopped.

**THE MARCONI "TYPE U" TRANSMITTER.**

The Marconi 500 watt Type U transmitter, which is described in a pamphlet just issued, is a self-contained unit mounted in a rigid open framework of angle iron. It is suitable for telephony or telegraphy and employs two valves of the T250 type.

For telephony one valve is used as an oscillator and the other as a modulator, while for C.W. telegraphy both valves are used as oscillators, the signalling switch being in the anode circuit.

Under normal conditions, with an aerial 70 feet high, the range for telephony is 150 miles, while for C.W. telegraphy it is 400 miles. The circuits of the oscillation generator are suitable for any wavelength between 300 and 4,000 metres.

No rectifying valves are required with

this transmitter, the high-tension supply at 3,000 volts being derived from a D.C. generator. The valve filaments are heated from a six-volt accumulator, which floats across the excitation winding of the generator.

**THE IMPERIAL WIRELESS COMMITTEE**

The first meeting of the Imperial Committee on Wireless Services, states the Postmaster-General, was held on June 23rd.

The following members have been nominated to the Committee:—

*Australia.*—Sir J. Cook, High Commissioner, and Mr. F. W. Mason Allard, Chairman of Amalgamated Wireless of Australasia, Ltd.

*Canada.*—Mr. Lucien Pacaud, Secretary to the High Commissioner, and Mr. H. W. Allen, Director of Marconi Wireless Telegraph Co. of Canada.

*India.*—Mr. J. G. P. Cameron, Indian Telegraph Department, and Mr. Nigel F. Paton, representing Indian Radio Telegraph Co.

*New Zealand.*—Sir J. Allen, High Commissioner, and Mr. J. Milward, late Manager in the Pacific of Pacific Cable Board.

*South Africa.*—Mr. J. S. Smit, High Commissioner, and Mr. H. E. Penrose, representing South African Wireless Telegraph Co. Col. E. A. Sturman, Postmaster-General of the Union of South Africa, will attend the Committee while he is in this country.

The Committee deals with questions such as hours of working, routing of messages, tariffs, and the classes of services to be operated by beam stations.

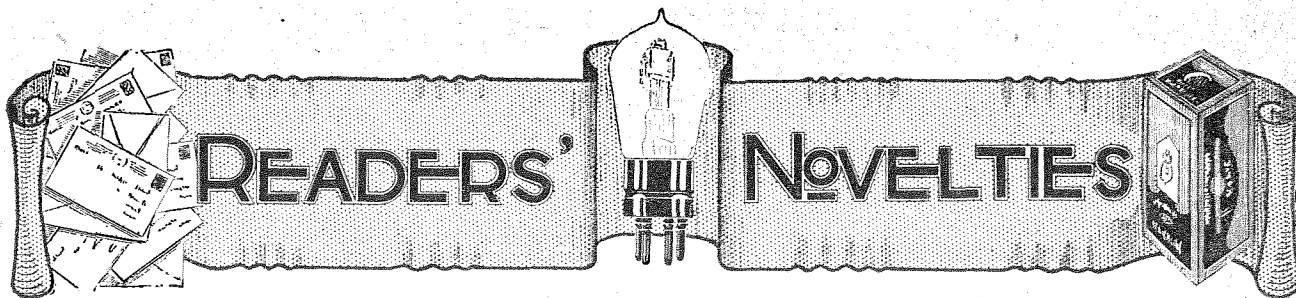

A Section Devoted to New Ideas and Practical Devices.

**CRYSTAL DETECTOR ADJUSTMENT.**

The pressure exerted by the catwhisker has a very marked influence on the performance of some varieties of synthetic galena, and it is generally found that those crystals which give the loudest signals require most adjustment before they can be induced to function properly.

The form of detector shown in the diagram is capable of giving a minute control over the movement of the catwhisker. Two short lengths of screwed rod are secured to the base board by lock-nuts. A piece of springy brass is fixed at one end to the rod A, the other end being drilled with a clearance hole to pass over C. The catwhisker, which is provided with a ball joint movement, is fitted to the brass spring at B. A suitable point on the crystal is chosen with the aid of the ball joint movement, and the final adjustment of the contact pressure is made with the knurled nut at C.

An extremely fine adjustment can be obtained by making the distance AB small compared with BC. The

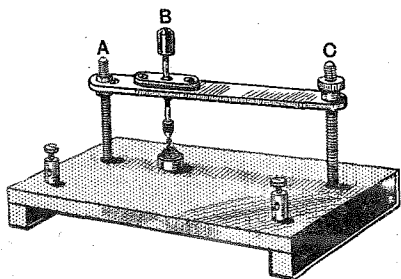

Catwhisker mounting giving fine adjustment of pressure.

brass spring should not be too thin, otherwise chattering may take place when the detector is subjected to external vibration. In connecting the detector in a receiving circuit, hand-capacity effects will be reduced if the catwhisker is connected to earth or a point of fixed potential.—W. J. S.

**SPRING CONTACT FOR SWITCHES AND CONDENSERS.**

The connection to the moving vanes of many cheap variable condensers is made through the spindle bearing itself. This contact is a

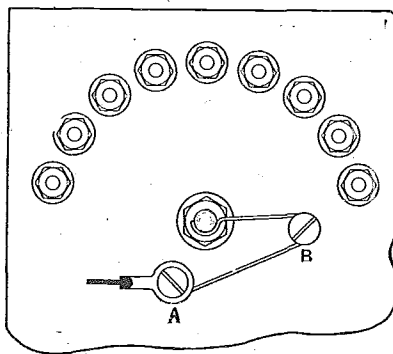

Switch or condenser spindle spring contact made from a safety pin.

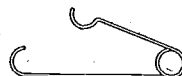

frequent cause of noise, particularly when the direction of rotation of the condenser has just been reversed. A very simple spring contact which will entirely eliminate this trouble can be constructed from an ordinary safety pin. The cap is removed and the wire bent to the form shown in the diagram. One end of the spring is then screwed to the insulating end plate of the condenser at A under a soldering lug or terminal. The coiled part of the spring is pivoted loosely to the end plate at B. A common connection should be taken from A to the original terminal on the bush; otherwise the small self-capacity of bush may prove a source of noise if the contact is intermittent.—L. S. B.

o o o o

**PROTECTION FROM LIGHTNING.**

When aeriels are erected in high, exposed places, special care must be

taken with the arrangements for earthing the aerial system during thunderstorms. In all cases the earthing switch must be placed outside the house, and in certain circumstances it may be advisable not to attach it directly to the wall of the house.

A switch box erected on a post at some distance from the house and operated by cords from the inside of the house affords the greatest protection from lightning. A hinged switch arm mounted vertically in the box is pulled into contact either with the lead-in to the set or to an efficient earth plate connection entering through insulators in the side of the box. The switch arm itself is connected to the aerial and is held in contact on either stud by the biasing weight. The gap between the switch contacts should be made as large as

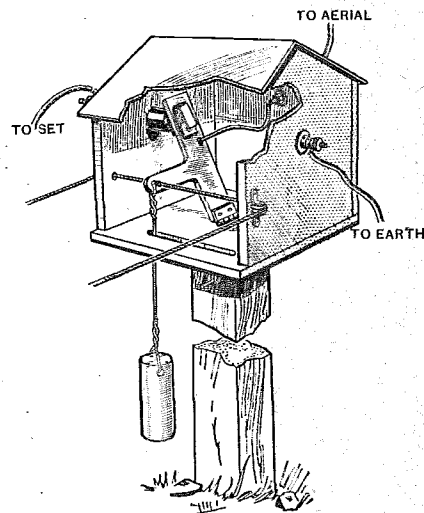

Lightning safety switch.

possible, and the success of the arrangement will depend upon the efficiency and directness of the earth connection.—E. E. W.

### AN ATTACHMENT FOR RADIAL SWITCHES.

A neat barrel switch can be quite easily fitted to the back of an ordinary radial switch in the following manner. A drum is cut from ebonite rod or tube and covered with a piece of brass tubing of equal length. The brass tube, even if a driving fit on the drum, should be secured with pegs or grub screws. If possible, a special spindle should be fitted to the switch of such a length that it will pass through the drum and take a lock nut at the end. The lock nut may be dispensed with, however, and the centre hole drilled and tapped if the existing spindle is not of sufficient length. The contact springs are carried on an ebonite bracket projecting at right angles from the main panel. With the contacts in position, the brass drum may be marked out and cut to give a variety of circuit changes. For instance, a series of three or four inductances each provided with tappings could be controlled by one radial switch giving progressively increasing wavelength ranges. The connections of the barrel switch would then be arranged to short circuit each inductance, as it

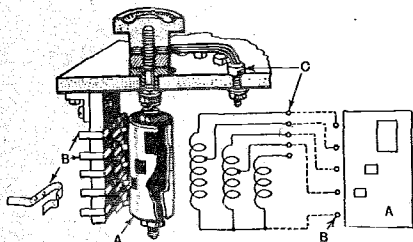

Dead-end switch for multi-coil tuners.

was superseded by the next in the series; and absorption effects due to the natural wavelength of the free coil would be eliminated. By using a series of coils in this way instead of one large coil, dead-end effects are considerably reduced.—F. A.

o o o o

### FILAMENT VOLTAGE CONTROL.

A single voltmeter may be used to control the filament voltage of each valve in a receiving set by means of the circuit arrangement shown in the diagram.

Small push switches, constructed from phosphor-bronze strip and mounted behind the panel, are fitted to each valve. The contacts should be of silver, if possible, though small

blobs of solder make good substitutes. The appearance of the finished receiver is considerably enhanced if a "flush" type voltmeter is fitted per-

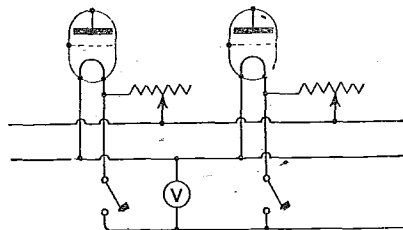
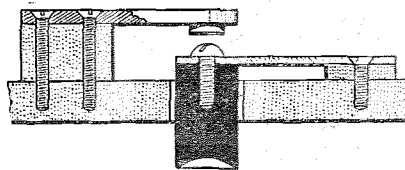

Filament voltmeter with push-button control.

manently behind the panel, but as an alternative two terminals could be used in order that the voltmeter may be connected externally.—R. T. W.

o o o o

### GRID LEAK CONNECTIONS.

In experimental work, connections are often soldered directly to the ends of grid leaks when supporting clips are not available. Unless low melting point solder is employed and considerable care is exercised in making the joint, the resistance of the leak is liable to change or even to break down completely. The risk of failure through overheating may be obviated by making the connections in the manner indicated in the diagram.



Temporary grid leak connections.

### VALVES FOR IDEAS.

Readers are invited to submit brief details, with rough sketches, where necessary, of devices of experimental interest for inclusion in this section. A receiving valve will be despatched to every reader whose idea is accepted for publication.

Letters should be addressed to the Editor, "Wireless World and Radio Review," 130, Fleet Street, London, E.C.4, and marked "Ideas."

The connecting wire, which should not be thinner than No. 20 S.W.G., is bent in the form of a loop and then bent at right angles so that a rubber band may be slipped over the ends of the wires to keep them in position. The contact obtained in this way is perfectly sound, and it is possible to replace the grid leak with one of different value in far less time than would be taken by soldering.—C. J. J.

o o o o

### FIXED AIR DIELECTRIC CONDENSERS.

The efficiency of short-wave receivers can be considerably increased by the use of fixed air dielectric condensers in place of the customary mica dielectric condensers.

A particularly neat method of building air condensers of this type is illustrated in the diagram. The use of spacing washers is obviated by soldering the condenser plates to vertical supporting pillars. Zinc and aluminium should, therefore, be avoided, and the plates should be cut from copper or brass. No. 16 S.W.G. copper wire can be used for the supports, which should be soldered into

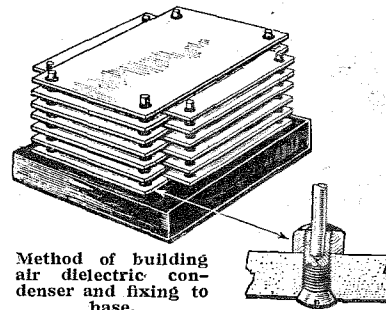

Method of building air dielectric condenser and fixing to base.

holes drilled into the ends of short 4BA countersunk screws. These are screwed into a square ebonite base, and the condenser plates, which have previously been tinned in the vicinity of the holes, are built up and clamped together with pieces of temporary packing. The packing pieces should be of such a size that they can be easily removed from the finished condenser, and may be cut from sheet ebonite, which will not retain much heat and will simplify the process of soldering. Softening of the ebonite is unlikely to take place, as the joints are easily made with a touch of the iron at each corner if the plates and supports are carefully tinned prior to assembly.—G. C.

# THE WORK OF A WIRELESS ENGINEER.

A Talk Given on Behalf of the Radio Society of Great Britain from 2LO on Saturday, June 13th.

By Dr. W. H. ECCLES, F.R.S.



Dr. W. H. Eccles, F.R.S.

PERHAPS the most striking feature of a wireless man's work is the contrast in size between the various things he deals with. At one moment he may be designing a tower weighing 300 tons, and at the next moment a catwhisker for tickling a crystal. I believe few other subjects furnish these great contrasts. They arise because wireless is now used to transmit messages across the greatest distances, and, therefore, the transmitting stations must be very powerful, and the receiving apparatus exceedingly delicate.

I suppose every one among my audience has had considerable experience of apparatus for the reception of wireless messages, so I propose to say little about the receiving side, and to concentrate on the transmitting side. I propose, in fact, to tell you about two or three of the great wireless transmitting stations I have visited in recent years.

### The High-Power Stations of France.

One of the most interesting of the great stations of the world is that one on the south-west coast of France, near Bordeaux. It was built by the Americans when they came into the war, so that their army could communicate direct with Washington, nearly 4,000 miles away. After the war it was bought by the French Government. To-day

a visitor approaching the station from the direction of Bordeaux passes first through a countryside full of vineyards, and then enters a region of pine woods covering a level plain extending to the sea. Long before he reaches the station he catches glimpses of its lofty towers.

When he comes nearer he can see that the station is in the middle of a clearing about two miles in diameter, and that the towers are eight in number, and that they are arranged to form a stately avenue pointing straight across the Atlantic Ocean to Washington. The towers resemble the Eiffel Tower in Paris, but they stand on three legs instead of four, and are more graceful and airy. The

first time I saw them was on a rather dull morning, and their tops were now and again hidden in the clouds, which all helped one to realise their great height. Actually they are about 800ft. high, which is only 180ft. short of the Eiffel Tower. Their purpose is to hold up a network of aerial wires, which, on the morning of my first visit, were quite invisible.

Down on the ground, at the end of the avenue of towers, is the building containing the machinery, and from this, long wires can be seen ascending to the aerial wires aloft. The building looks tiny compared with the towers, but as the visitor draws near to it he finds that it is an imposing structure

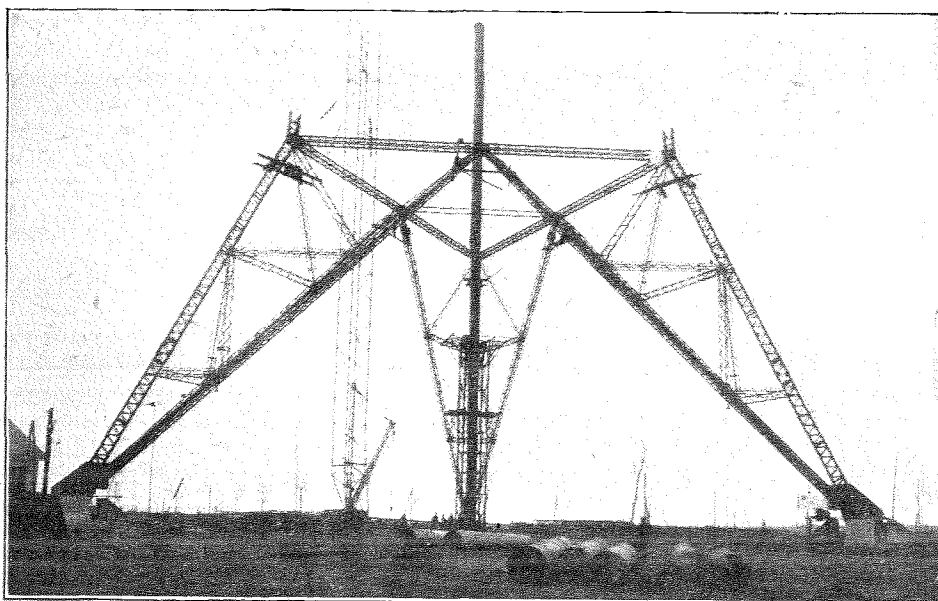

Masts and self-supporting towers in course of construction at Koenigswuzterhausen.

**The Work of a Wireless Engineer.—**

about sixty yards long. The principal room in it is the machinery hall; in this is a group of roaring motors and dynamos, which deliver electric current to a magnetic arc seen in the background. The magnetic arc is one of the best forms of apparatus for making the powerful high-frequency currents which are sent into the aerial wires. The one at work here is about 1,300 h.p. In external dimensions it is the size of a large elephant. There are, in fact, two of these elephants, one of which works while the other rests and is cleaned. They are the largest arcs ever built.

For sending dots and dashes, a Morse key is necessary, but as the current to be controlled is enormous, it is divided among a row of seventy-eight large Morse keys all rising and falling together. They are operated automatically by a tiny electric current which has come on the telegraph lines from Paris, where a telegraphist sits at a table and taps a small Morse key. It is fascinating to see and hear the seventy-eight big keys moving all together like well-drilled soldiers at the bidding of an operator hundreds of miles away. It is difficult to realise that the clatter of these keys will be heard by wireless receiving operators in America and written down as a message.

**The Masts of St. Assise.**

Besides the station just described, France possesses three other magnificent wireless stations, of which the largest is at St. Assise, near Paris, and is the largest in the world. This station has sixteen steel masts, each 820ft. high, forming an avenue nearly two miles long. These masts hold up aerial wires of which the total length is thirty miles. The masts do not stand on feet like the Bordeaux Towers, but are held upright by slanting guy wires fixed to the ground. The station building has a frontage of 250ft., and contains two palatial machinery halls. Here the high-frequency currents are made, not by magnetic arcs, but by machines called Latour alternators, named after their inventor. The power employed is about 2,000 h.p., and is controlled by a telegraph key in Paris.

A visit to these two great French stations makes one ask which is the better construction, towers standing on their own legs, or masts held up by guy ropes? Either of them will serve the purpose of the wireless engineer, who uses them merely to hold up as much aerial wire as possible as high as possible. Masts are usually less costly than towers, but which of them is safer in a storm? Experience in Europe indicates that towers are stronger than masts. At any rate, I do not remember

to have heard of a big tower being blown down, though I know of several high masts being wrecked. On the other hand, masts have sometimes proved unexpectedly tough. For instance, a few years ago a seaplane flew straight into a mast at Portsmouth 450ft. high and wedged its nose so firmly into the lattice work that it stuck there like a nail in a gatepost. At the impact the pilot was shot from his cockpit against the mast and fell stunned on one of the wings of the plane, thus narrowly escaping a fall of 300ft. He remained in this precarious condition until a courageous marine climbed up the bent mast and rescued him. Later the wrecked plane was lowered in pieces, and the mast repaired and straightened.

**The Imperial Station at Rugby.**

Among the great wireless stations of the world the new Imperial station at Rugby, which is now being erected by the Post Office Engineering Department, must be given an important place. It is situated about three miles from Rugby on a site about a mile and a half long by a mile wide, and comprising nine hundred acres. There is room for sixteen masts, of which twelve are now nearly finished. These masts are 825ft. high and are supported by steel guy ropes fastened to the ground. Railway travellers passing through Rugby and looking at these masts do not usually realise their great height. There is nothing near enough to them to serve as a standard, and the few tall trees in the neighbourhood are so dwarfed by comparison that they look like gooseberry bushes. If the Nelson Column could be put near one of the masts it would be seen to be only one-sixth as high, or if St. Paul's Cathedral were placed alongside a mast the Cross on the dome would not reach half-way. Inside each mast is a lift worked by an electric motor; this can carry four or five men to the top in about a quarter of an hour. There is also a ladder up which nimble people can climb in about half an hour. The whole mast is supported on porcelain insulators, and can rock slightly on a joint at the bottom; in a high wind the top of the mast sways gently to and fro about 8ft.

These twelve masts are the tallest structures in the British Empire. They have been erected without a single serious accident, a feat greatly to the credit of the contractors and the workmen. There have been exciting incidents, of course. I recall that on one occasion the lift was at its highest stopping place just beneath the platform which caps the mast, and a number of workmen got into the cage in order to descend. An extra man climbed on to the top of the cage, as there was no room inside.

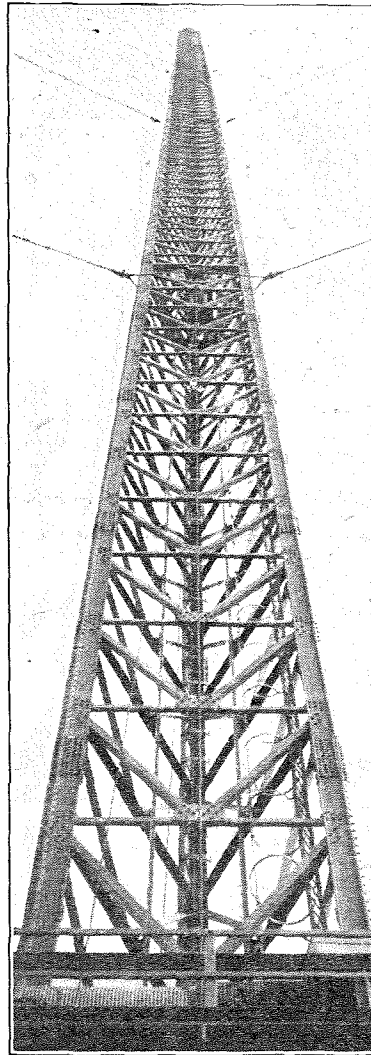

One of the twelve masts at the Imperial Wireless Station at Hillmorton, Rugby.



**The Work of a Wireless Engineer.—**

The signal to lower away was given, but instead of descending, the lift started rising, with the result that the man standing on the cage was in danger of being crushed underneath the top platform. To save himself, he made a flying leap into empty space, caught at a hanging rope, and held on. I need not say that he was speedily hauled back into safety.

The masts are for the purpose of holding up the aerial wires. These are slung between the top of the masts in festoons each a quarter of a mile long. Altogether, about thirty miles of thick wire—that is, as much as would reach from London to Guildford—are suspended at the giddy height of 800ft. From these aerial wires other wires descend to the station building far below.

The building contains three great halls: a machinery hall measuring 185ft. by 47ft., a valve room 103ft. by 40ft., and a high-frequency room as big as the valve room but 52ft. in height. In this room the girders supporting the roof are of pine wood, because steel girders can be made red-hot by having near them the enormous high-frequency currents running in the coils and condensers installed there. The coils are for tuning the aerial wires; just as my hearers tune their receiving sets, but the Rugby coils are monstrous things, weighing 5 tons, whereas yours probably weigh a few ounces, and the cable used in making them contains 6,561 strands of wire. As for the condensers, they are exactly like the mica condensers in your receiving set, except that they weigh 10 tons.

**The World's Largest Valve Station.**

Rugby is unique in the respect that valves are used on an unparalleled scale for generating the high-frequency currents for the aerial wires. Eighty-four big valves are being installed. The valves are very like those you may be using at this moment in your receiving set, but each Rugby valve consumes about one thousand times the energy taken by a receiving valve. The valves would get very hot unless cooled, so a reservoir containing half a million gallons of water with the necessary pumping machinery has been excavated for cooling them.

The Rugby station is the first high-power station ever equipped solely with valves. This form of equipment was decided upon by the Government, because the valve method is very adaptable. A valve station with high masts can do more things than can a station employing arcs as alternators. For instance, a valve station can transmit short waves as easily as long waves, and thus any wavelength from the shortest to the longest—say, from 10 metres to 20,000 metres—can be radiated if desired. Moreover, the masts at Rugby are so arranged

that, if desired, reflectors can be erected for projecting short waves in useful directions in the form of beams. Again, the valve method is the fastest of all methods; speeds of a thousand words a minute have been reached experimentally in this country. In addition, a valve station can transmit messages by the voice as well as by the Morse code; in other words, a valve station is a telephone as well as a telegraph station.

The Postmaster-General has announced that telephone trials across the Atlantic will start during the coming winter. If the tests are successful, anyone who can be connected on the trunk telephone line to Rugby will be heard at the corresponding New York station, and his voice will be sent over the American trunk lines to any subscriber. As there are already a number of trunk lines connecting certain Continental countries to London and Rugby, the new station will enable a large area of Europe to be connected by telephone to the North American continent. Later it may be found possible to extend these facilities to more distant parts of the world.

**Empire Communications.**

But apart from its telephonic possibilities the Imperial station will certainly render great national service as a transmitting centre of wireless telegrams, both in plain language and in cypher. For instance, it will enable Whitehall to transmit instructions to military expeditions anywhere and to ships on any sea of the globe. Finally, it will spread all round it messages conveying news and information of general interest to be simultaneously received in every part of the Empire. This, surely, is the most important contribution any instrument of communication can ever make to the mutual understanding and cohesion of the British peoples.

o o o o

**A NEW MAIL SHIP.**

THE s.s. *Chitral*, the fifth of a fleet of eight new ships being built for the P. and O. Steam Navigation Company, recently ran a series of successful trials in the Clyde, and will be employed in that company's Australian Mail Service.

The wireless equipment with which this vessel was furnished was manufactured and fitted by Radio Communication Co., Ltd. The main installation comprises a 1½-kw. spark transmitter with a daylight range of 800 miles, and a c.w. transmitter with a daylight range of 1,500 miles, while an emergency spark set, worked from a battery of accumulators, is provided for use in case of any possible breakdown of the power supply from the engine room.

A wireless direction finder is also fitted.

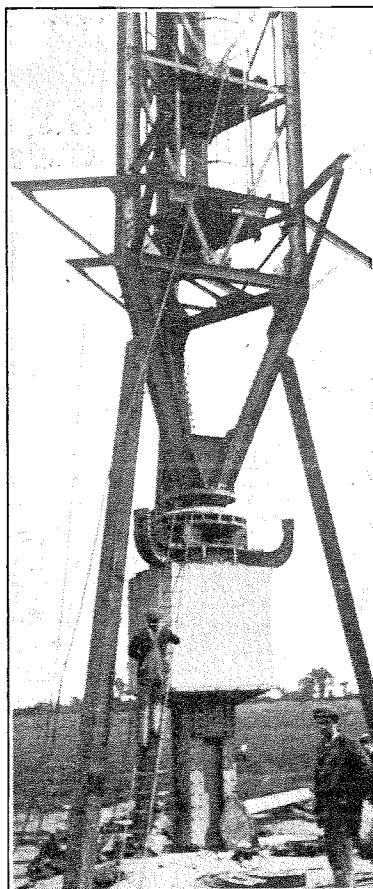

Porcelain insulator and supporting joint at the base of one of the Rugby masts.

## VALVES WE HAVE TESTED.

## The Louden Dull Emitters.

Types F.E.1 and F.E.2.

THE well-known Louden valve is now manufactured with a dull emitting filament, and sample valves have been received from Messrs. Fellows Magneto Co., Ltd., the makers.

Having had an opportunity of testing the bright emitters<sup>1</sup> very thoroughly, we were especially interested in applying laboratory tests to the new arrivals.

## H.F. and L.F. Types.

Two types are made—the F.E.R.1, which corresponds to the bright emitting F1, and is intended for detection and low-frequency amplification, and the F.E.R.2, which is designed for H.F. work, and is the dull emitting counterpart of the F.2.

Both types are rated at 0.1 ampere filament current, but they are supplied for either 4- or 6-volt circuits, and the appropriate type can therefore be immediately substituted without alterations or additions to an existing set.

## General Construction.

The general construction adopted in the earlier types remains unchanged, the anode being in the form of a spiral of thick wire slightly shorter in length than the spiral grid.

The point of outstanding interest is the filament system of the 6-volt variety. Instead of the usual single-wire coaxial with the grid, a double filament is used. Actually the system consists of two filaments, connected in parallel, and arranged closely side by side. Due, however, to their being so close together, and consequent interaction, the total emission, though greater than that which would be obtained from a single filament, is not doubled.

## Laboratory Tests.

Our usual tests were performed on the four valves submitted to us, and the results as given in the tables show, in a concise form, their individual performances.

The emission on all four types was particularly liberal. It was, in fact, much higher than is generally required, and actually, for all practical purposes, ample emission was obtained at 0.5 volt below the rated value, and our main tests were carried out at this figure—that is, 3.5 volts for the 4.0-volt type, and 5.5 volts for the 6-volt.

In this connection we would once more urge the advisability of always running valve filaments at the lowest possible voltage consistent with good reception, and never to exceed the maker's figures. The lower the filament voltage, the longer the life of the valve will be.

Suitably adjusted, all four types gave good results under practical working conditions. We note that the maximum plate voltage is given as 80 volts in every case; if this could be increased to, say, 100 in the case of the

F.E.R.1 (L.F. valve), even better results, we think, would ensue.

The 4-volt valve sells at 12s., and the 6-volt at 13s. 6d.; both represent good value for money.

## LOUDEN F.E.R.2 4-VOLT.

For use as a high frequency amplifier.  
(Fellows Magneto Co., Ltd.)

Filament Volts, 3.5. Filament Current, 0.1 amp.  
Emission (total), Milliamps 8.7.

Plate Volts.	Plate Current at Zero Grid.	Grid Bias.	Plate <sup>1</sup> Current. Milliamps.	Amplification Factor.	Impedance.
40	0.52	0	0.52	12.35	47,700
60	1.01	-1	0.7	11.9	42,000
80	1.6	-2	0.9	11.9	37,000

<sup>1</sup> Plate current when grid is biased to the value of Col. III.

## LOUDEN F.E.R.2. 6-VOLT.

For use as a high frequency amplifier.  
(Fellows Magneto Co., Ltd.)

Filament Volts, 5.5. Filament Current, .1 amp.  
Emission (total), Milliamps 12.

Plate Volts.	Plate Current at Zero Grid.	Grid Bias.	Plate <sup>1</sup> Current. Milliamps.	Amplification Factor.	Impedance.
40	0.46	0	0.46	14.5	57,000
60	0.86	-1	0.55	14.2	54,000
80	1.34	-2	0.66	14.18	51,000

<sup>1</sup> Plate current when grid is biased to the value of Col. III.

## LOUDEN F.E.R.1. 4-VOLT.

For use as a low frequency amplifier or detector.  
(Fellows Magneto Co., Ltd.)

Filament Volts, 3.5. Filament Current, .105 amp.  
Emission (total), Milliamps 12.4.

Plate Volts.	Plate Current at Zero Grid.	Grid Bias.	Plate <sup>1</sup> Current. Milliamps.	Amplification Factor.	Impedance.
40	1.2	-1.5	0.8	5.8	23,000
60	2.02	-3.0	1.33	5.9	20,000
80	3.35	-4.5	1.88	6.0	18,200

<sup>1</sup> Plate current when grid is biased to the value of Col. III.

## LOUDEN F.E.R.1. 6-VOLT.

For use as a low frequency amplifier or detector.  
(Fellows Magneto Co., Ltd.)

Filament Volts, 5.5. Filament Current, .103 amp.  
Emission (total), Milliamps 7.9.

Plate Volts.	Plate Current at Zero Grid.	Grid Bias.	Plate <sup>1</sup> Current. Milliamps.	Amplification Factor.	Impedance.
40	1.07	-1.5	0.67	6.2	26,600
60	2.2	-3.0	1.11	6.6	21,600
80	3.5	-4.5	1.6	6.6	20,000

<sup>1</sup> Plate current when grid is biased to the value of Col. III.

<sup>1</sup> *Wireless World*, April 8th, 1925.

# Broadcast Brevities

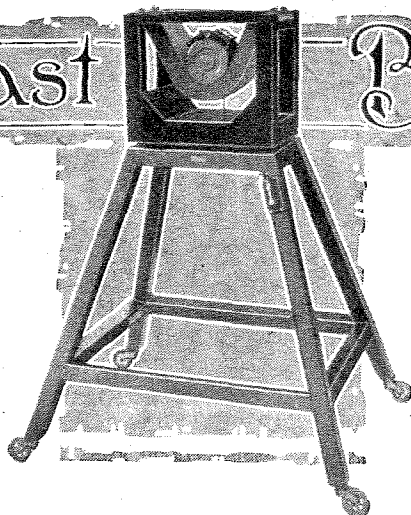

## SAVOY HILL

### From Paris.

The mid-day concerts from Paris are providing numbers of listeners in this country with earlier broadcast entertainment, and this has resulted in a little eulogy from a South of England newspaper which says (*inter alia*) that we owe a lot to our friends across the water for the privilege granted to English people who have leisure to listen to programmes comparatively early in the day.

o o o o

### A Question of Authority.

The inference is that the B.B.C. should emulate the example of Radio-Paris and give full-blooded programmes at lunch time or earlier, but the fact is too often overlooked that in this matter, as in so many others, Savoy Hill is in the hands of the Government authorities who not only control the broadcasting hours, but have practically power of life and death over programmes and policy. If ever the question of morning broadcasts becomes pressing, officials at Savoy Hill would, I understand, have first to consider the financial aspects, to which reference has previously been made in these notes. The question of additional staff would also have to be carefully considered.

o o o o

### Need of Additional Income.

The obvious corollary of increased expenditure on this and several other items is additional income, and listeners must await the advent of the Wireless Bill foreshadowed by the Prime Minister, in which it is believed the position as regards existing licences and the future of the licensing system will be clarified.

o o o o

### Aerials.

The average aerial, as the chief engineer of broadcast in Britain might say, is a perfectly harmless affair. It only needs a little judicious attention to keep it in perfect order. But occasionally it is subjected to cavalier treatment, and thus it comes about that municipal authorities, with the blessing of a Select Committee of the House of Lords, are empowered to prohibit aerials that are likely to be dangerous to the community.

o o o o

### The Capricious Landlord.

But another aspect has been put forward by several listeners who pride themselves on the possession of the knowledge and ability to erect the genuinely harmless but efficient aerial. Why not a law, is the demand, to prevent capricious land-

## TOPICALITIES.

lords from prohibiting the erection of aerials altogether? Many cases have occurred in which landlords have refused permission for aerials to be erected on their property, but have declined to assign any reason for the prohibition. The question arises whether such refusal does not amount to interference with the liberty of the subject.

o o o o

### Musical Revues.

I understand that the first of the musical revues with which the name of Mr. James Lester, the B.B.C.'s latest acquisition, will be associated, will be broadcast on July 6, 9, 11 and 17. Some misunderstanding appears to exist over the work which Mr. Lester will do. Briefly, he will, I am informed, assist in the production of the lighter side of broadcasting entertainment, but the actual responsibility for all dramatic productions will remain in the hands of Mr. R. E. Jeffrey. The aim is to combine a knowledge of the musical revue and musical comedy with that of the requirements of broadcast. Listeners will be able to judge of the results for themselves.

o o o o

### Holidays in Both Hemispheres

The difficulties attendant upon broadcasting in this country are not by any means fully realised by listeners. For instance, so apparently innocent a matter as the broadcast of seaside resorts during the holiday season has met with a certain amount of opposition. "It may be all very well," remarks one objector, "to broadcast municipal orchestras, the songs of pierrots and other local noises for the benefit of those about to start on a holiday; but what about those people who have just returned from holiday? Will they thank the B.B.C. for calling up memories of an all too brief fortnight or so spent by the sea-shore of what was, and all that might have been?"

o o o o

### In the Future.

This correspondent's complaint is probably unjustified. At any rate, we may take it that the day is not far distant when listeners will hear a background of local noises from Bridlington, Blackpool and Eastbourne, or will be able to receive, if they prefer, the local noises from well-known Continental watering-places, such as Dinard, Dieppe and Ostend, or tune in to receive the shouts of South African holiday makers surf-riding at Cape Town, or the accents of Fifth Avenue at Palm Beach.

### FUTURE FEATURES.

#### Sunday, June 28th.

LONDON.—3.30 p.m., Organ Recital from the Bishopsgate Institute, by Reginald Goss-Custard. 4 p.m., Sybil Thorndike and Lewis Casson in "The Medea."

CARDIFF.—9 p.m., Arthurian Legends.

MANCHESTER.—3.30 p.m., Chamber Music.

NEWCASTLE.—9 p.m., Orlando Gibbons Tercentenary.

#### Monday, June 29th.

LONDON.—8 p.m., Musical Comedy and Humour.

PLYMOUTH.—3 p.m., Speech by H.R.H. Prince Henry at opening of Plymouth Hospitals Exhibition.

#### Tuesday, June 30th.

LONDON.—9 p.m., Railway Centenary Celebration.

MANCHESTER.—1.15 p.m., Mid-day Society's Concert, relayed from the Houldsworth Hall.

5XX.—8 p.m., Ballad Concert.

#### Wednesday, July 1st.

LONDON.—9 p.m., Canada.

GLASGOW.—8 p.m., Operatic Night.

#### Thursday, July 2nd.

LONDON.—8 p.m., Act. III. of "Orpheus" (Gluck).

BIRMINGHAM.—8 p.m., Music and Drama.

#### Friday, July 3rd.

LONDON.—8 p.m., An Hour (or so) in an Estaminet. John Henry and "The Roosters."

GLASGOW.—8 p.m., Band of H.M. Royal Air Force.

#### Saturday, July 4th.

LONDON.—8 p.m., Independence Day—A Programme for American Listeners.

BOURNEMOUTH.—8 p.m., Revue.

MANCHESTER.—8 p.m., Hail Columbia!

**Day v. Night Transmissions.**

Will daylight transmissions ever equal those of the night hours? The B.B.C. engineers to whom I put the question pronounce against this possibility. The "Heaviside Layer" overhangs the earth like a thick cloud at night, forming a sort of "whispering gallery," but in the day-time it is diffused into minute particles and the cloud-like or "whispering-gallery" effect is less pronounced.

○○○○

**Shorter Wavelengths.**

In the course of developments, however, shorter wavelengths will become practicable for broadcasting. A wavelength of about thirty metres transmits well during the day; while signals on the broadcast wave-band get very tired during the hours of daylight, whereas at night they are reflected and refracted. It is, therefore, conceivable that transmissions in the day-time for broadcast purposes will be on wavelengths at present not contemplated by those responsible for their allocation.

○○○○

**Law Court News by Wireless.**

A new feature of the programmes from the Frankfurt Station is the daily summary of law cases, in which the decisions of the German Higher Courts are given together with *résumés* of trials. It is hoped that these items will stimulate public interest in the law. At all events they will probably serve as warnings.

○○○○

**League of Nations to be Broadcast.**

According to a Continental correspondent, the proceedings of the League of



**AN OPEN-AIR BROADCAST SERVICE.** A photograph taken on a recent Sunday on Brighton pier, where a large gathering participated in a broadcast religious service. The loud-speaker is an Amplion type A.R.31.

Nations may be broadcast next autumn. Offers to transmit the proceedings have been made by the Eiffel Tower, Breslau, Frankfort, Munich, Rome, and Vienna stations. It seems probable that the League will accede to these requests.

○○○○

**Bee-Keeping and Wireless.**

The bulletin of the Lancashire Bee Keepers' Association has for some time

been a regular weekly feature of the Manchester programmes. The Vice-president of the Association is now able to state that the bulletin is being of the greatest service to the Association. Interest in bee keeping has been stimulated, many new members having been enrolled since the bulletin was first broadcast. The knowledge imparted is also of great use, and it is possible in this way to keep members acquainted with the movements of the Association's expert, who travels throughout the county to give advice and practical help.

○○○○

**A Light Symphony Concert.**

Although formal symphony concerts have been abandoned at Manchester during the summer months, a light symphony concert has been arranged for the afternoon of Sunday, July 5th, the artists being Miss Helen Anderton (contralto), Mr. Victor Helliwell (bass), and the 22Y Augmented Orchestra, conducted by Mr. T. H. Morrison. Requests are continually being received for Tchaikovsky's "Cass Noisette" Suite, and accordingly this piece has been included in the programme.

○○○○

**A Jarring Problem.**

There is a dearth of jam jars in Aberdeen. The reason is not only that the juvenile Aberdonian likes jam, but that Mr. R. M. Neill, the Keeper of the Natural History Museum, is giving talks in the 2BD Children's Corner on how to keep tadpoles, sticklebacks, and water-beetles alive and healthy at home; and to follow instructions each boy and girl needs six jam jars. Mr. Neill's next series will be on "Sea Shore Shells," and the adult population of Aberdeen contemplates embarking on a diet of cockles and mussels.

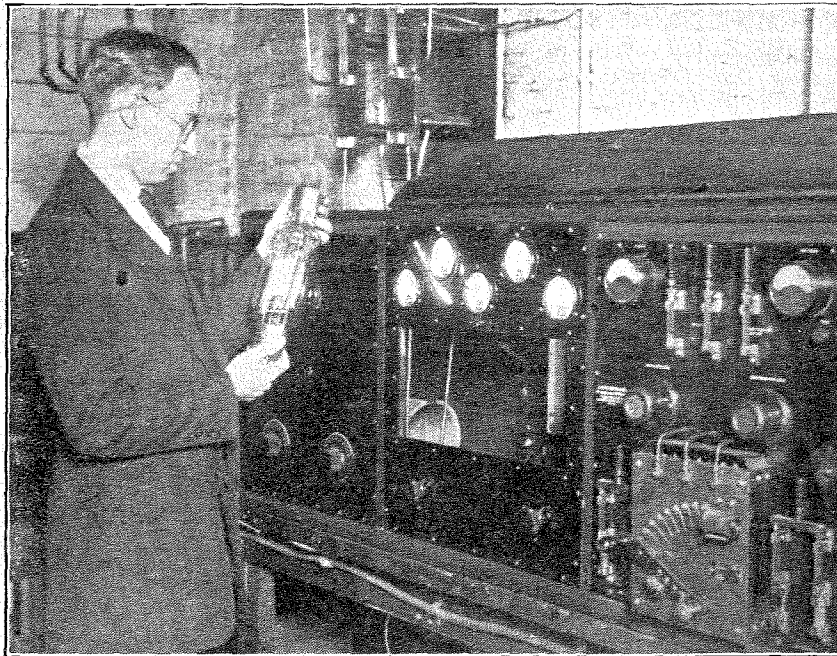

**BROADCAST TRANSMITTER IN CHURCH.** The new one-kilowatt equipment at WSAP, which is situated in the crypt of the New York City Temple. Services have been broadcast from this church for some time past, but the new apparatus is considerably more powerful than the old.

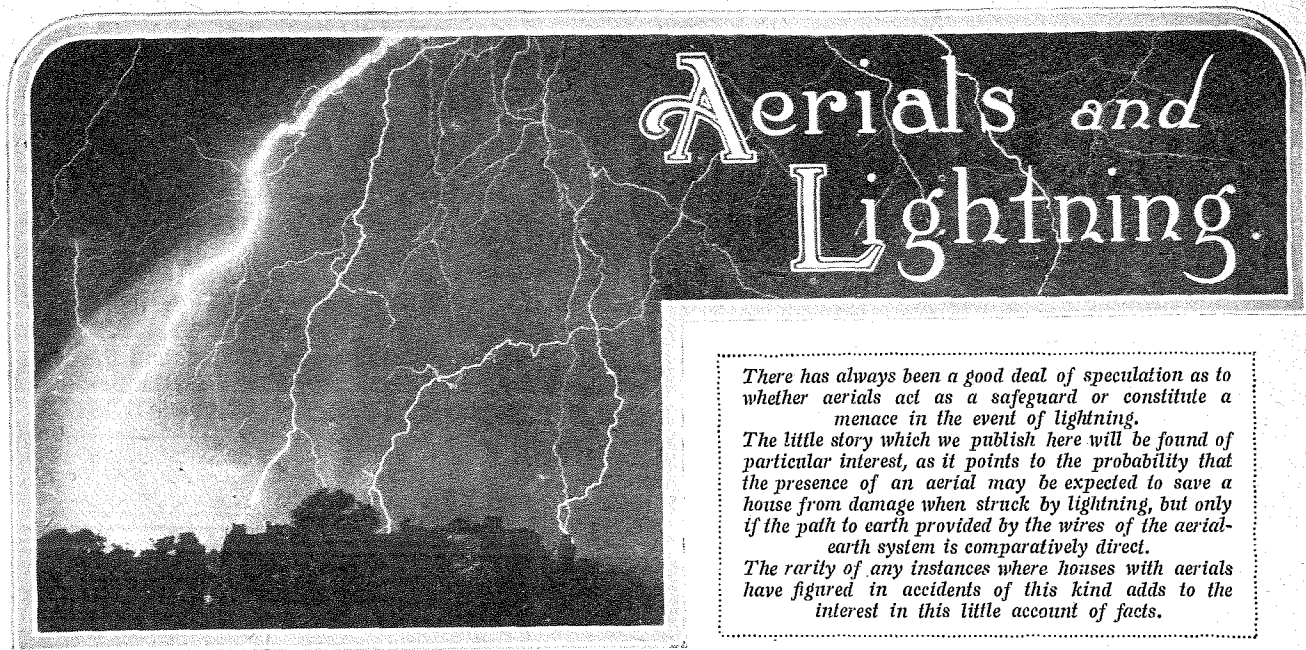

*There has always been a good deal of speculation as to whether aerials act as a safeguard or constitute a menace in the event of lightning. The little story which we publish here will be found of particular interest, as it points to the probability that the presence of an aerial may be expected to save a house from damage when struck by lightning, but only if the path to earth provided by the wires of the aerial-earth system is comparatively direct. The rarity of any instances where houses with aerials have figured in accidents of this kind adds to the interest in this little account of facts.*

By JOHN CITIZEN.

THE average wireless amateur takes reasonable precautions with his aerial installation in thundery weather, but the minority who are either absurdly nervous or criminally reckless may be interested to have precise details of an actual case in which an aerial was struck.

The installation in question is so heavily screened by high ground and trees that the supplying firm rather pooched the buyer's request for a safety switch. A single wire, 60ft. high, is attached at the free end to a 90ft. tree by wire rope. At the house end it is secured by rope halliards to a guyed mast, stepped in the ground. The 40ft. lead-in is soldered to the usual 2BA brass rod, insulated by a light ebonite tube from the oak frame of a window. Inside the window a short insulated wire leads to the common type of D.P.D.T. switch on a porcelain base. The earth lead of electron wire runs in one piece from an old zinc bath at the bottom of a 20ft. well just outside the window through a hole in the oak sill of the window to the D.P.D.T. switch. Thus both lead-in and earth wire bend sharply at right angles to enter the house, there being a vertical gap of 2ft. between them. The only insulators on the aerial are two of the large corrugated type made by the General Electric Co., one at each end.

#### Listening in to 5XX.

The family were listening in to 5XX one Sunday when the weather grew stormy, and rumblings of distant thunder were audible. The switch was immediately thrown to safety, and the two leads to the set from the switch were disconnected and left hanging: The storm came nearer, and presently a mighty crash shook the entire building—a substantially built farmhouse. A brilliant blue discharge was observed through the window, and when the party had recovered from their fright, they investigated affairs outside. The discharge had injured

nothing inside the building, but had clearly leapt the 2ft. vertical gap between the right-angle bends in the lead-in and earth wires. The glass of the window was blackened in a line parallel with this gap. The earth wire had been destroyed by fusing over a length which could not be measured, as its exact original length was unknown; and the insulation was burnt off it below the fused portion. The wall was also blackened at several points where the earth lead had run down it.

#### Preference for a Straight Path.

There are two or three points of interest in this lucky escape which are not particularly speculative. First and foremost, freakish as lightning often seems to be, it displayed in this instance a decided preference for the straight path, choosing the 2ft. air gap in the straight downward line to earth, rather than following the continuous conductor into the house, through six right angles and out again. A tiny safety spark gap between aerial and earth, mounted outside the house in the straight line to earth, will usually confer more safety than an elaborate switch inside the house, with its concomitant right angles.

Secondly, it is almost certain that the tree was originally struck—it has been struck before—and if so, it is conceivable that the discharge would have passed harmlessly to earth through the trunk if the connection to the aerial had been by non-conducting rope halliards or through plenty of insulators, arranged at right angles to the impact, *i.e.*, horizontally. Actually, the aerial is linked to the tree by wire rope, and isolated by one insulator only. This is of special interest, for the sequel is yet to be told. Ten minutes after the first shock, the house was struck again, there being no longer any direct earth path from the aerial. This time the current appears to have travelled down the down wire from the aerial, and to have been mortified (so to speak) at finding no direct earth path. Anyhow, it leaped across to the roof, sent

**Aerials and Lightning.**—

the tiles flying, and went to earth *via* an enormous galvanised water tank just beneath the roof. There is very little speculation in this diagnosis, as the down wire passes quite close to the tank, and the roof damage was along the shortest path between these two conductors. The owner has been advised to replace the wire rope between tree and aerial with rope, and to insert a longish string of insulators at the free end; also, if possible, to top the tree, which has a large, spreading head.

On the following Sunday, although the weather was stormy, there was no visible lightning or audible thunder, and the party again tuned in 5XX, chatting about their fright of the previous week. A certain item in the programme did not interest them, and they switched off. One of them, with a joke about the previous Sunday,

threw the earth-aerial switch over. As he did so, there was an audible "Pst!" They looked at each other, and he proceeded to open and close the switch repeatedly. Though there, was no thunder about, he could get blue sparks up to  $\frac{1}{4}$  in. every time he earthed the aerial; and the sparks increased in frequency as the gap was narrowed.

As this building stands amongst surroundings calculated to trap electrical discharges long before they reach its low level, it is evident that precautions should never be neglected because a house stands low and is screened by high trees and high ground. The morals of this particular incident, rare as such cases are, indicate the value of the safety gap in a straight line, and the advisability of using cord rather than wire for halliards and suspension purposes.

**TRIAL UPON TRIAL.****Broadcast Test on Motor Run.**

**A** STRENUOUS and searching test of a standard five-valve broadcast receiver was carried out with success during the Whitsun Motor Trial between London and Edinburgh.

The set was a "Cosmos" (Metro-Vick Supplies, Ltd.),

At the start perfect loud-speaker reception was obtained from London and 5XX, the quality of reception being maintained until Towcester was reached, 67 miles from London. It was then noticed that interference was present when reducing speed round corners, and this was

(Above) The wireless-equipped "Bean" car which participated in the London to Edinburgh motor trial. Note the small aerial. The body of the car acted as a counterpoise. (Below) The "Cosmos" 5-valve receiver which gave excellent loud-speaker results during the greater part of the run.

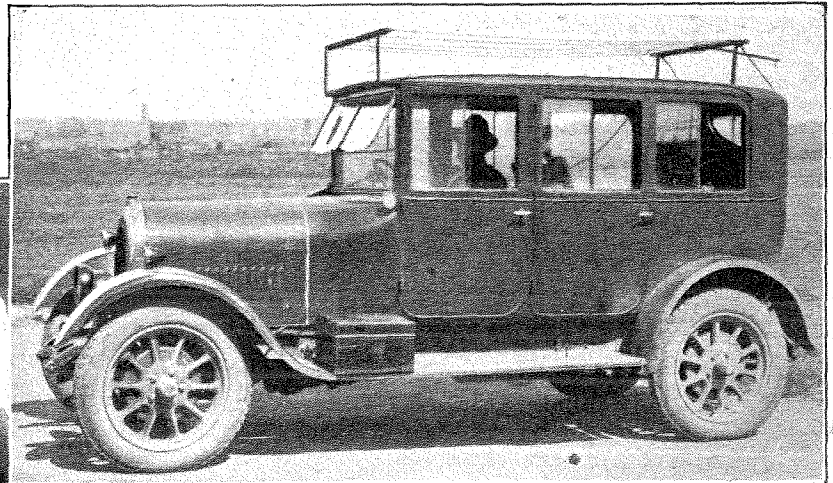
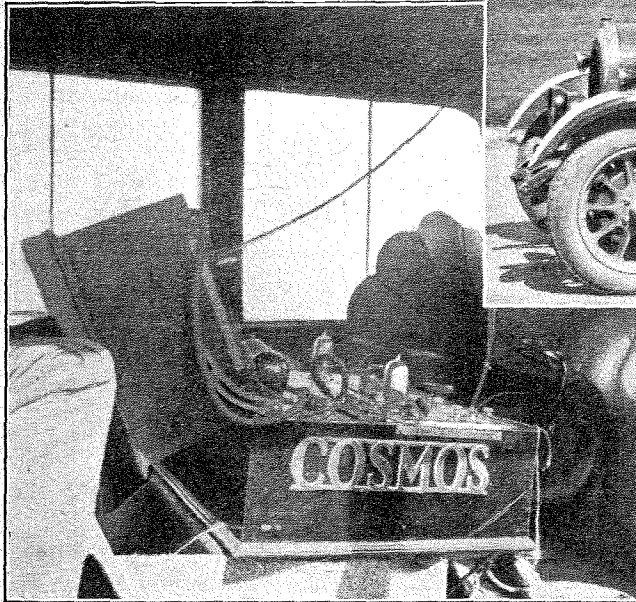

traced to the generator of the car not giving full voltage.

At 3.30 in the afternoon, when Carlisle was reached, Newcastle was heard at fair loud-speaker strength; Glasgow could just be heard on arrival at Moffat. Fading was very pronounced in this district, owing to the hills on either side, but 25 miles out from Moffat the Edinburgh Relay Station made a fair impression on the loud-speaker.

After the B.B.C. stations had closed down, music was heard in the telephones when only three valves were used, and, as the wavelength was approximately 510 metres, the station was understood to be Berlin. It was found impossible, however, to tune in this transmission on the loud-speaker owing to the extreme roughness of the road.

mounted in a "Bean" car, which carried as an aerial a number of short overhead parallel wires, the body of the car functioning as a counterpoise earth.

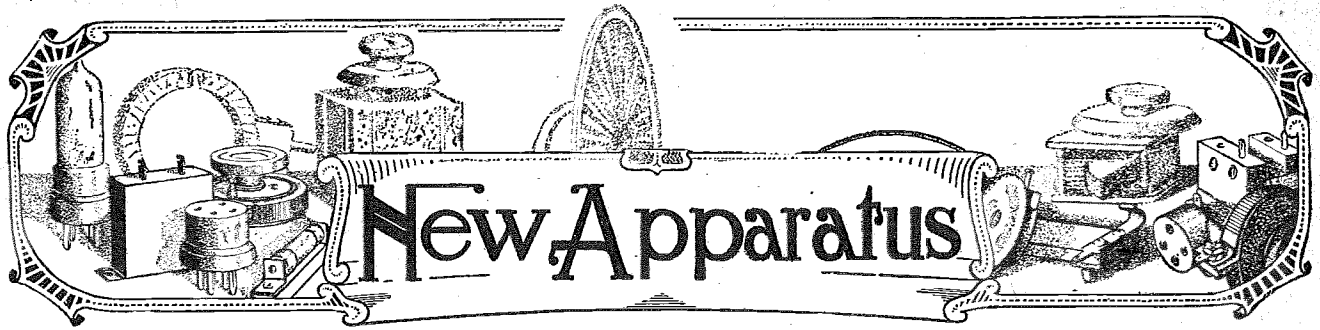

A Review of the Latest Products of the Manufacturers.

**THE ERICSSON CRYSTAL DETECTOR.**

The extensive use of crystal detectors for use in the construction of simple broadcast receivers has caused much attention to be devoted to crystal detector design. The aim should be to provide an adjustment by means of which a good detecting point on the crystal face can easily be found and the correct critical pressure readily applied.

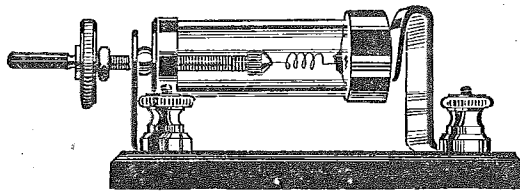

The British Ericsson Company's crystal detector.

The British Ericsson Co. have introduced a new detector which is simple to adjust and is not fitted with a number of auxiliary controls which one sometimes finds on detector mountings, rendering the operation difficult. It is easily demountable, giving ready access to the crystal. The contacts are protected by a glass tube.

Critical adjustment is provided by means of a fine thread passing through a ball, so that contact can be obtained with any point on the face of the crystal, while a coarse adjustment is produced by a plunger action of an auxiliary stem which passes right through the threaded spindle and to which the catwhisker is actually attached.

It is a robust form of crystal detector, sensitive and easy to adjust.

o o o o

**LAMPLUGH FILAMENT RHEOSTAT.**

The design of the new filament rheostat by Messrs. Lamplugh & Co., Ltd., King's Road, Tyseley, Birmingham, deserves

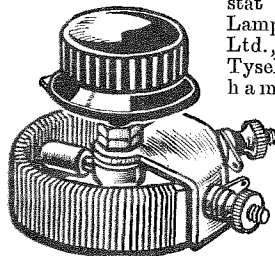

Lamplugh filament rheostat.

mention, as a plunger is employed to make contact with the surface of the wire instead of the usual rubbing

spring. A small metal plate carries the bearing for one-hole fixing and gives support to a fibre strip upon which the resistance wire is wound. Contact is made on the inner face of the winding and to allow for small irregularities in its curvature, a spring-applied plunger is employed for making reliable contact. By this means a very smooth movement is obtained.

o o o o

**THE ALEMBOIC LIGHTNING PROTECTOR.**

A porcelain moulding is employed to carry the equipment, which consists of an aerial-earth change-over switch, an arrester gap and fuse.

The gap, which is made between the surfaces of two carbon rods, is, of course, connected between the aerial and earth wires, whilst the fuse is connected in series with the aerial. This is a convenient arrangement for earth and aerial and does, to a considerable measure, protect

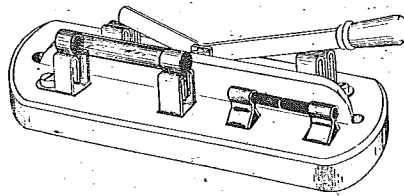

Lightning protector, fitted with protecting fuse and arrester gap.

the receiving equipment even when the switch is left in the position so that the aerial is connected through to the instruments.

The component parts are already wired up and the wiring sealed in at the back of the porcelain panel, which very much simplifies the work of installing. The metal parts are of copper and treated to give them a durable finish.

The arrester is a product of Messrs. J. Millet, 22, Farrington Avenue, London, E.C.4.

o o o o

**COMBINED AERIAL SWITCH AND LEAD-IN TUBE.**

It is usually considered desirable to earth the aerial when not in use, earthing arrangement being provided out-of-doors. Messrs. E. Shipton & Co., Westminster,

London, S.W., have recently introduced a leading-in tube in which the rod which conveys the connection to the aerial is utilised for externally connecting the aerial to earth. To the outside of the ebonite tube a pair of clips is fitted, one at either end. The aerial rod carries at its extremities forked spring contacts which, in turn, engage upon the rings de-

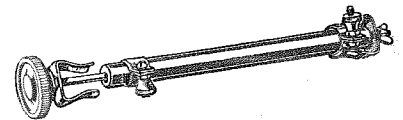

Rotary change-over switch.

pending whether the rod is depressed or pulled out. Thus in one position the aerial is connected through to the instruments, the lead being taken from one of the clips. In the other position the aerial is disconnected from the receiving apparatus and externally earthed by engaging on the other clip, to which is attached an earth wire.

o o o o

**PLUG AND SOCKET CONNECTORS.**

Plugs and sockets have many applications in the construction of wireless apparatus and, as a result, an extensive range is now available on the market.

A type recently introduced by Messrs. Lamplugh & Co., Ltd., King's Road, Tyseley, Birmingham, is interesting, inasmuch as the usual split pin has been abandoned and is replaced by a four-spring faced peg. By this means an easy

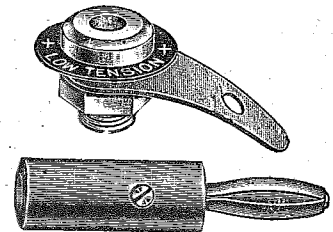

Lamplugh plug and socket connector.

fit is obtained in the socket and reliable contact ensured. The plugs and sockets are well finished, nickel plated and polished and are supplied complete with circular label for indicating the terminal connections usually employed in receiver construction.

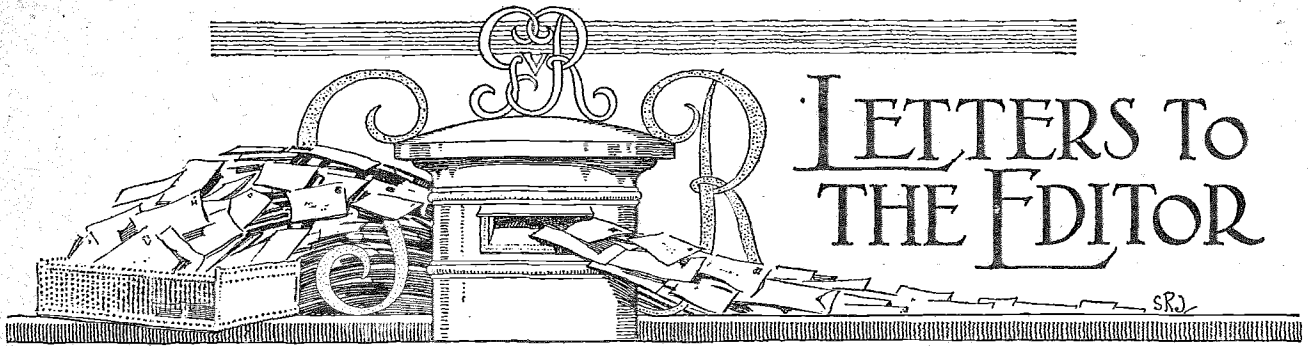

The Editor does not hold himself responsible for the opinions of his correspondents.

Correspondence should be addressed to the Editor, "The Wireless World," 139-140, Fleet Street, E.C.4, and must be accompanied by the writer's name and address.

#### NOISES FROM ELECTRIC LIGHT WIRES.

Sir,—In houses wired for electric light and heating it is quite possible for broadcast receiving to be marred by a humming noise in the headphones due to induction on the wiring. With crystal sets and a 50-cycle supply this may be so loud in comparison with the broadcast signals as to be irritating to the listener, while on a 100-cycle supply, such as exists in certain towns, it becomes a recognised nuisance.

There are various systems of wiring houses for electric light, in some of which the insulated conductors are covered with a metal sheath, while in others there is no such metal coating. As this metal sheathing is connected to earth one would expect houses wired with the metal sheathed wiring systems to be less subject to this interference with wireless signals than those where the wires are not so protected, but to obtain definite data on the point, a simple experiment has been carried out in these laboratories, the results of which may interest your readers.

About 50 yards each of Henley wiring system twin cable, and a similar length of twin insulated cable, not metal sheathed, were disposed about the laboratory and connected to the two sides of a 2-way switch, which enabled one or the other to be made alive with a 250-volt 50-cycle supply.

The headphones of a crystal set placed within a few feet of the cables gave perfect silence with the Henley cable connected, but a perceptible hum with the unprotected rubber. On connecting a 3-valve amplifier and loud-speaker to the output of the crystal set, the induction from the rubber covered cable developed into a loud note which would spoil any broadcast programme, while when we switched over to the Henley wiring only the faintest note could be detected, and this was evidently due to other wiring about the laboratory, probably lamp flexibles, as it was present whether the switch was open or closed.

It is evident then that in order to avoid interference with wireless receiving sets a metal covered house wiring system has considerable advantages over the unprotected rubber covered wire.

Research Laboratories,  
W. T. Henley's Telegraph Works Co., Ltd.

P. DUNSHEATH.

#### B.B.C. AND DISTANT RECEPTION.

Sir,—A most interesting suggestion is made in the *Radio Times* correspondence column this week that each station of the B.B.C. should close for one day per month. I suggest that you give the fullest publicity to this suggestion.

I have made the alternative suggestion that the wavelength should be changed for that one day, but quite see that there are difficulties in the way.

When one considers the tremendous number of receiving sets which are within a radius of one mile of each main station, most of which cannot receive signals differing in wavelength by less than 75 metres from that of the local station, it is easy to realise what a boon one silent night per month would be. In my own case, for example, it would enable me to calibrate my receiver for Glasgow, Swansea, Belfast, Aberdeen, Vienna,

Rome, l'Ecole Superieure, Hamburg, Münster, Vox Haus, Stuttgart, Frankfurt, Königsberg, München, Stockholm, and Zürich.

The fact that the suggestion has been published in the B.B.C.'s official organ shows that they would consider the matter if they were assured that people wanted a silent night. Secretaries of wireless clubs would do well to get their members to sign a memorandum on the subject at their next meeting.

Birmingham.

J. WELLING.

#### THE QSL QUESTION.

Sir,—With reference to "R.E.F.'s" letter in your issue dated June 3rd regarding the sending of QSL cards by non-transmitters, I have sent about 120 cards out in the last nine months and have had 80 acknowledgments. I have cards from Mexico, Canada, U.S.A., Australia, and all the European countries, and in nearly every case I was thanked very much for my reports.

Owing to the fact that short-wave signals as a rule travel a long way, it is rather useless sending cards to the big "British noises" who get across to Australia and the U.S.A. regularly, but I have found the Continental and American amateurs particularly grateful. If one has a den it is rather interesting trying to cover the walls with QSL cards in their many varieties of colours, and also it serves to show the efficiency of the receiver.

NORMAN GUY.

Pinner, Middlesex.

Sir,—I wish to endorse the remarks by "R.E.F." on transmitters' non-acknowledgment of reports. Most amateur transmitters seem to suffer from a deplorable lack of good manners. Reports, however numerous or useless, should in common courtesy be answered, especially when any information is asked for. If, however, this is too much trouble why do not transmitters keep a pile of stamped postcards and a pencil somewhere near the set and write short acknowledgments during the intervals which occur frequently in experimental transmission. Just "Many thanks for your report.—2XYZ." would be sufficient. If no reports are wanted why not say so at intervals during transmission. A three letter abbreviation could be devised for code work. Still, if amateurs had discouraged reports in the old days would amateur radio be where it is to-day?

C. F. P.

Sir,—In recent numbers of your periodical several allusions have been made to the use of QSL cards by receiving amateurs.

A special "reception" card has been used by me for the past year in forwarding reports, and from the numerous letters I have received, apart from cards, the "wallpaper" has been very much appreciated.

I need not comment on the absence of transmitters in Erin. Wishing your journal the best of luck.

H. GOLDSBROUGH.

Fethard,  
Co. Tipperary,  
Ireland.